Doing astronomy with SDSS

Željko Ivezić
University of Washington

The Second Summer School in Astronomy
Oct 1, 2008; Belgrade, Serbia

The Lectures' Main Goals

Digital imaging is ubiquitous in modern observational astronomy (remember 36-frame films?), and the algorithms used for data analysis are becoming ever more complex. The past few years have seen the advent of many terabytes of publicly available data, and petabytes of data are expected from next-generation surveys.

A user requires a sophisticated understanding of the data and either how to process it, or of the steps that some other team took.

1. **Minimum goal:** to familiarize you with the contemporary survey work, with emphasis on SDSS
2. **Enhanced goal:** to motivate you to use surveys in your own work, and to make you a more powerful and efficient researcher

The main questions: What can modern sky surveys do for you, and should you care?

Answers: A lot, and an unconditional yes!.

Modern sky surveys, riding the wave of technology (telescope making, CCDs, computer revolution), are producing tens of terabytes of data for hundreds of millions of sources (soon petabytes and billions of sources).

All these data are public – the only limit to science outcome is your imagination and expertise.

Democratization and globalization of science

The Lecture Plan

1. Lecture I:

- Brief overview of survey astronomy
- Introduction to SDSS
- What SDSS data exist and how to access them

2. Lectures II and III: Examples of SDSS Science

- Solar System, Stars and the Milky Way
- Galaxies, AGNs, Quasars and Cosmology

3. Lecture IV: SDSS is not everything!

- Other Wavelengths
- Back to the Future: from SDSS to LSST

What is a sky map? Why do we make sky maps?

- What is a sky map?

- A list of all detected objects (stars, galaxies, etc.)
- A list of their measured parameters (brightness, colors, size, etc.)

- Why do we make sky maps?

- Object classification (e.g. stars vs. galaxies vs. asteroids vs. quasars)
- Statistical Analysis (e.g. how many quasars are there?)
- Discovery of new types of objects (e.g. recently brown dwarfs, gravitational lenses)

Astronomical Frontiers

Astronomical Frontiers

- **Big Telescopes:** Keck, Very Large Telescope, Gemini (10m class), important for faint objects (especially for spectroscopic observations); can detect objects 100 million times fainter than detectable by the human eye

Astronomical Frontiers

- **Big Telescopes:** Keck, Very Large Telescope, Gemini (10m class), important for faint objects
- **Hubble Space Telescope:** the best angular resolution (~ 0.1 second of arc): ~ 1000 times better than the human eye)





Astronomical Frontiers

- **Big Telescopes:** Keck, Very Large Telescope, Gemini (10m class), important for faint objects
- **Hubble Space Telescope:** the best angular resolution (~ 0.1 second of arc): ~ 1000 times better than the human eye)
- **All sky surveys:** over billion objects, enormous databases, enable unbiased studies

Optical Surveys

- **Hipparchos:** 3,000 stars visible by the naked eye; the main source of astronomical observations for the next 2,500 years!
- **Tycho Brahe:** much more accurate than Hipparchos, still without a telescope
- **and many others...**

Optical Surveys

- **Hipparchos:** 3,000 stars visible by the naked eye; the main source of astronomical observations for the next 2,500 years!
- **Tycho Brahe:** much more accurate than Hipparchos, still without a telescope
- **and many others...**
- **Palomar Observatory Sky Survey:** (first 1950-57, second 1985-1999) photographic, nearly all-sky, two bands, $m < 20.5$, astrometric accuracy ~ 0.5 arcsec, photometric accuracy 0.2-0.4 mag (both very non-Gaussian), USNO-B catalog: 10^9 sources

Optical Surveys: Fast Recent Progress!

- **Palomar Observatory Sky Survey:** (first 1950-57, second 1985-1999) photographic, nearly all-sky, two bands, $m < 20.5$, astrometric accuracy ~ 0.5 arcsec, photometric accuracy 0.2-0.4 mag (both very non-Gaussian), USNO-B catalog: 10^9 sources
- **SDSS:** digital not photographic, 5 bands not 2, $m < 22.5$, astrometric accuracy < 0.1 arcsec absolute, ~ 0.02 arcsec relative, photometric accuracy 0.02 mag (both nearly Gaussian), 1/4 of the sky, several 10^8 sources (no Galactic plane coverage)

Sloan Digital Sky Survey

- **Images** of over 100 million stars and 100 million galaxies
- **Spectra** for 1 million galaxies, 100,000 quasars, and 100,000 stars
- Over **20 TB of data** - more than the US Library of Congress





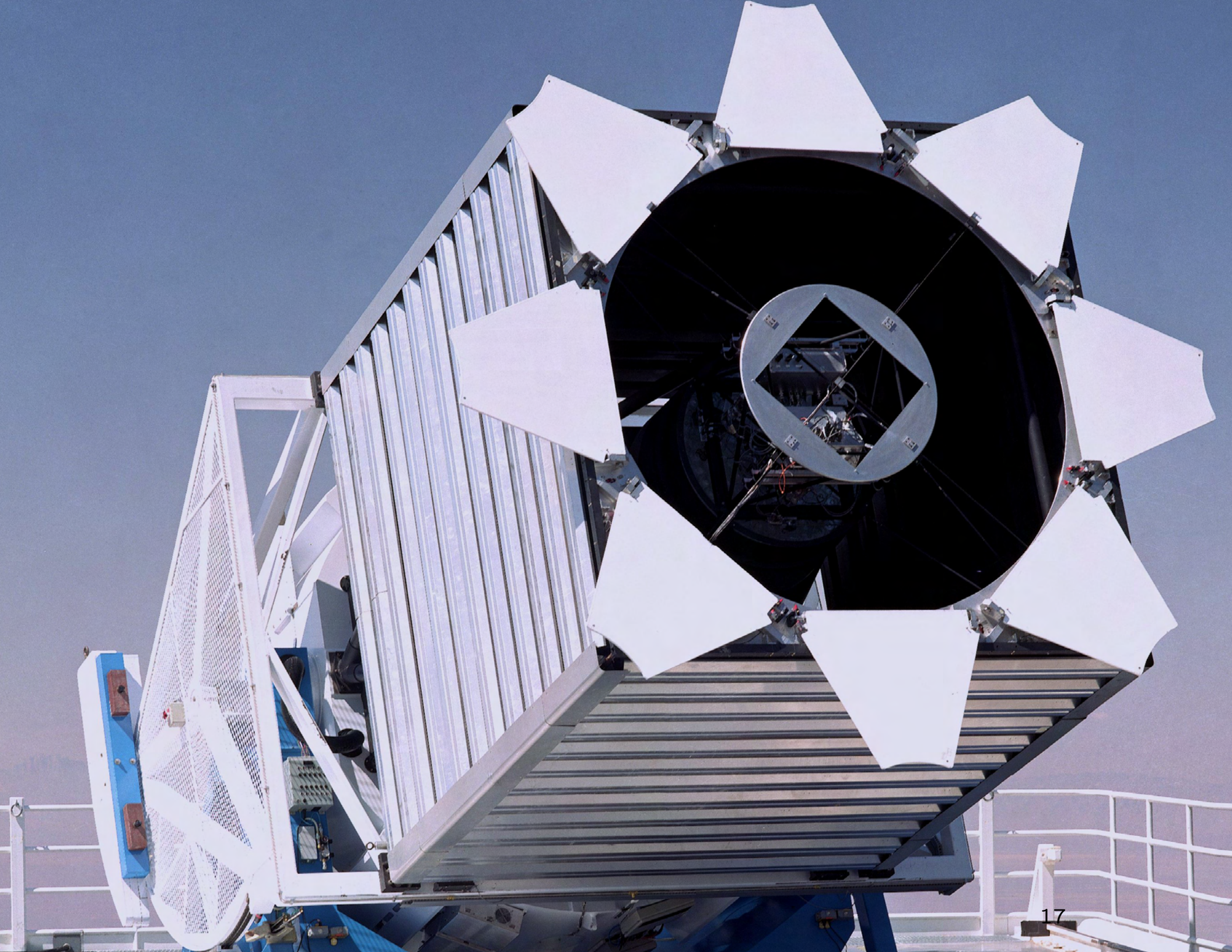

The heart of SDSS: the largest astronomical camera (until recently)

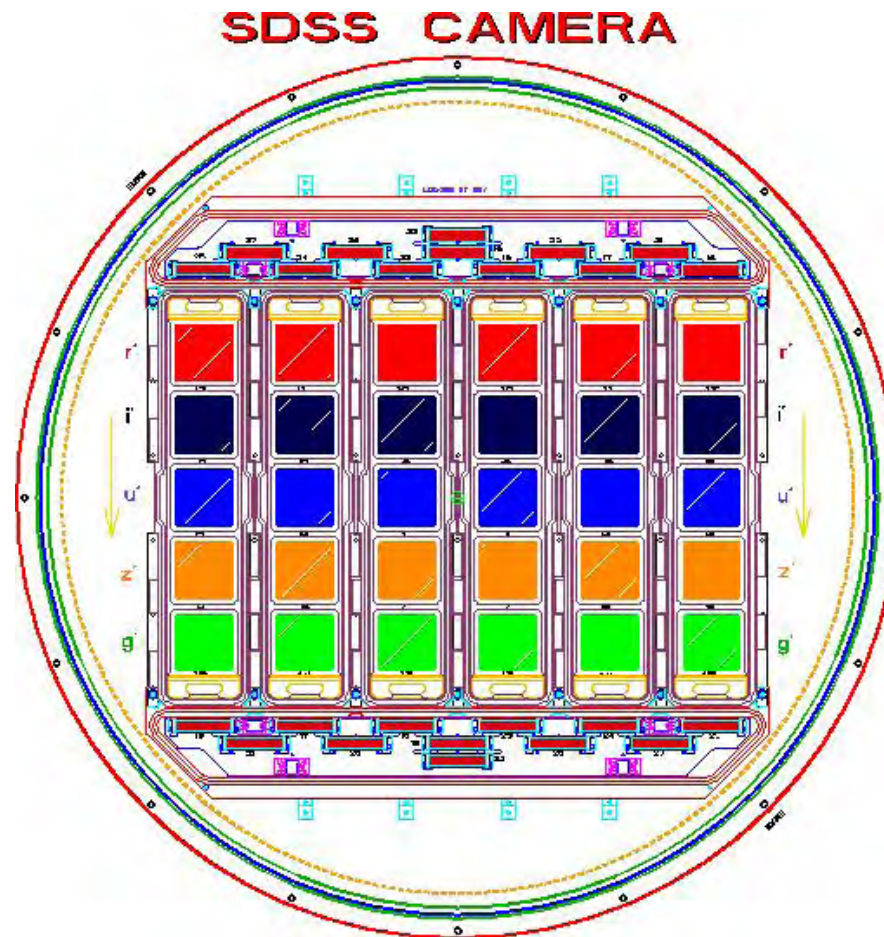

30 2048x2048 CCDs, total 120 Megapixel

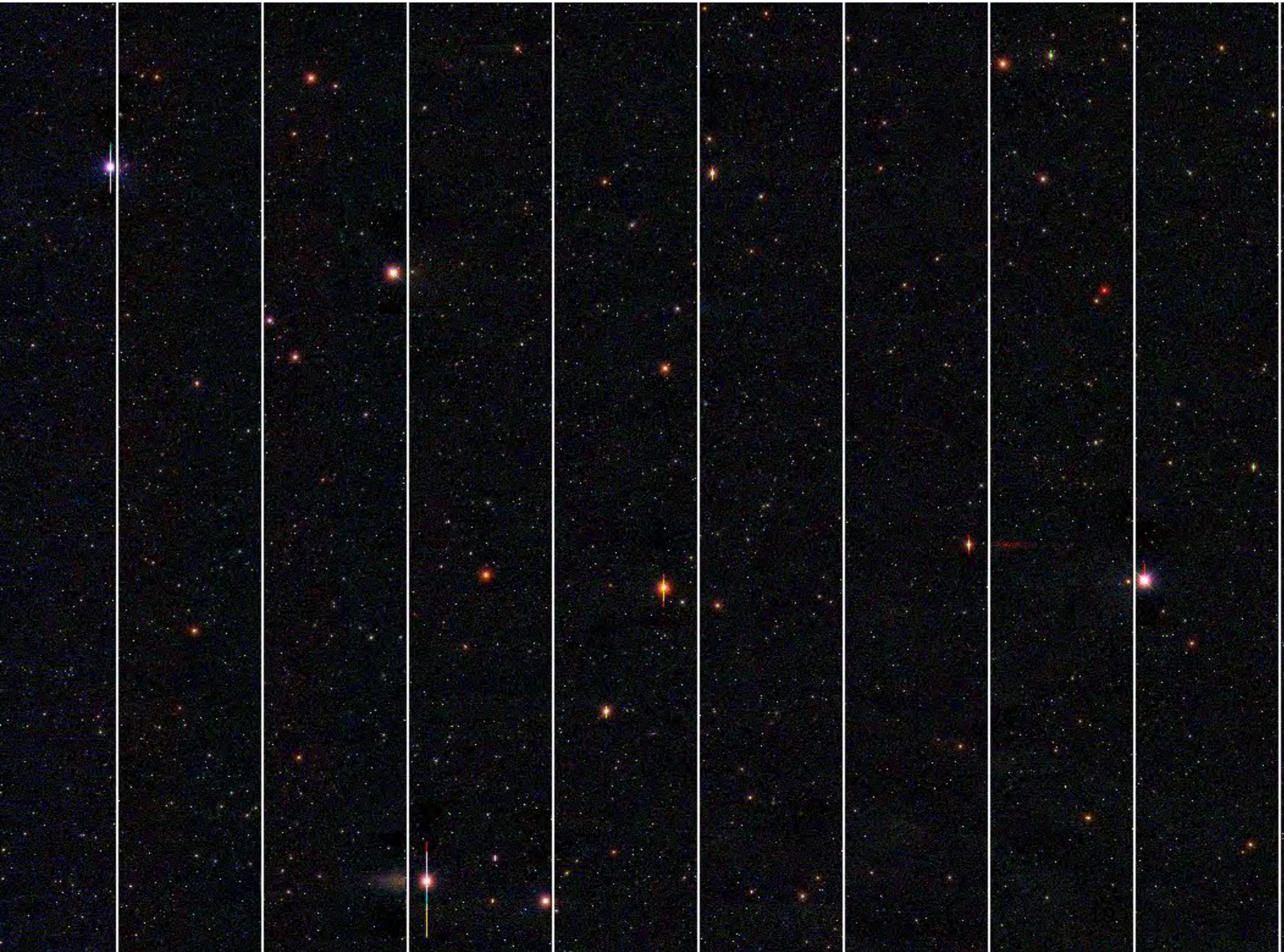



















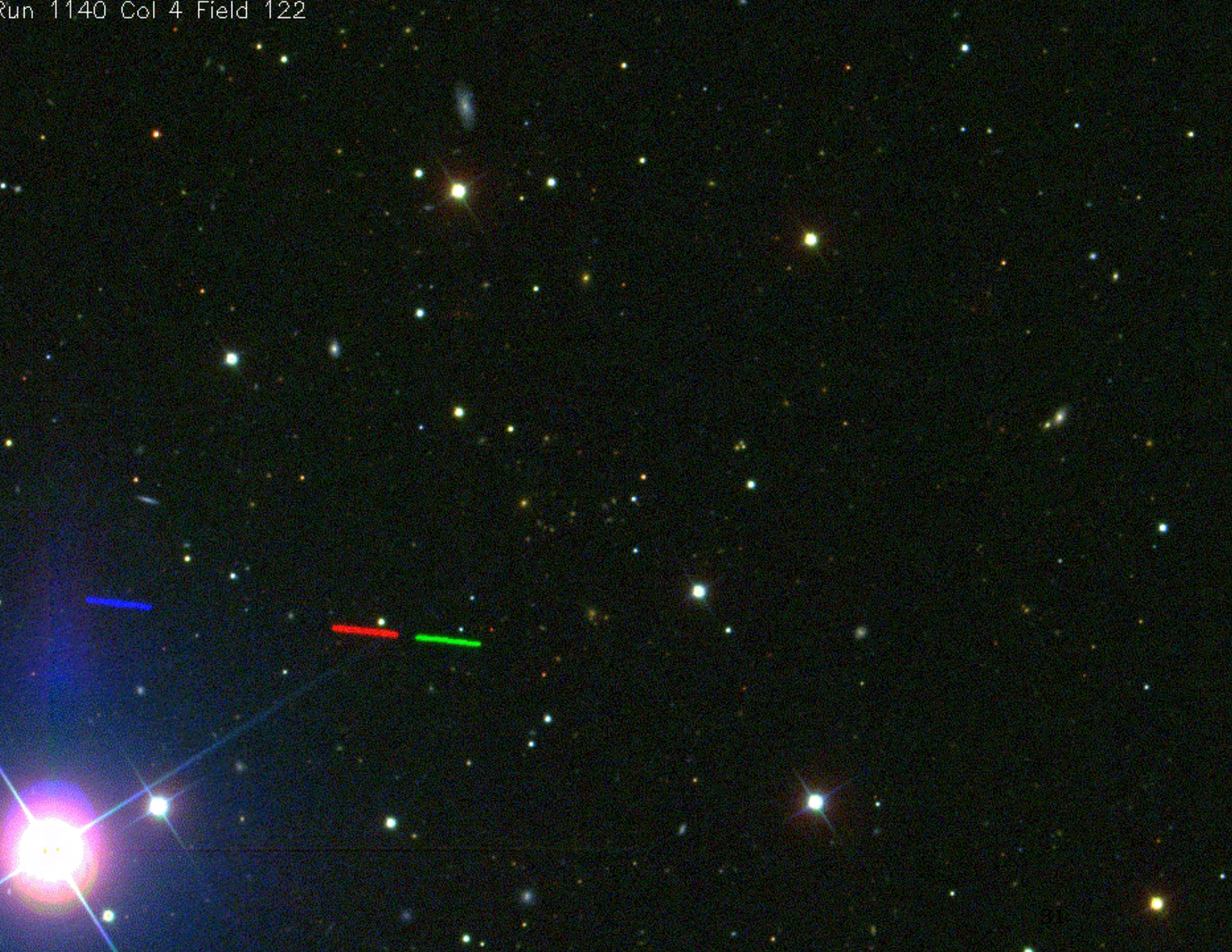

The most distant known quasar



gri

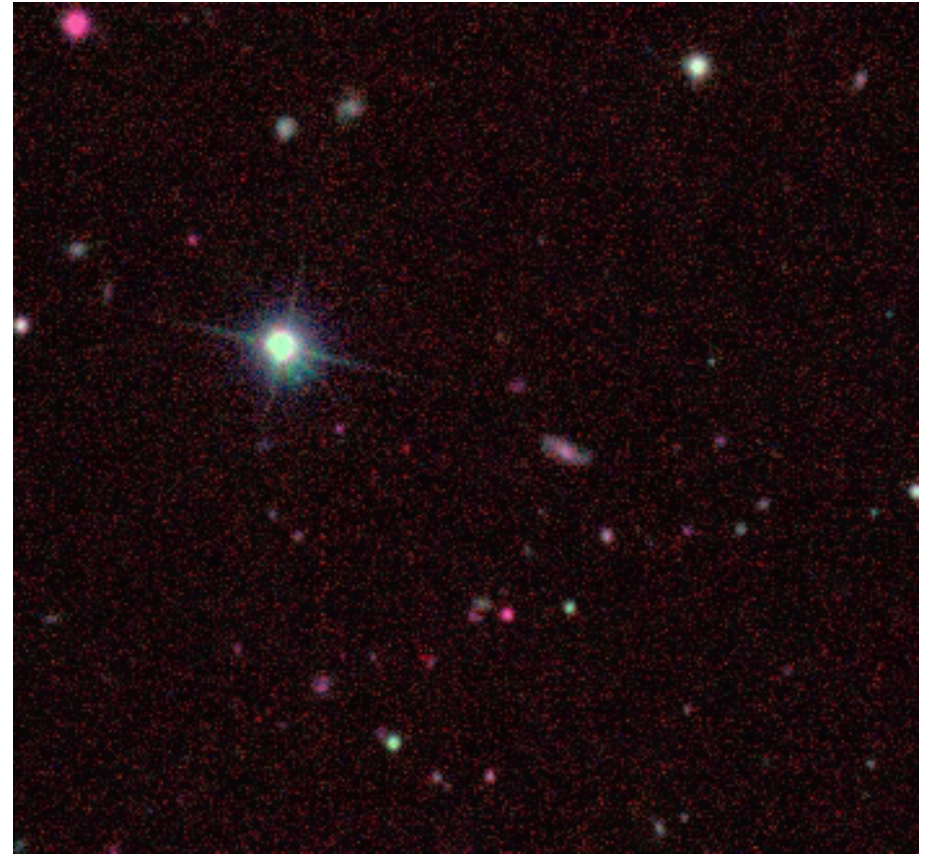

riz

In the right image between the star and galaxy, and a little bit down

The Impact of SDSS

Extraordinary range of science themes and huge scientific legacy

- In less than a decade $>2,000$ SDSS papers with $>50,000$ citations; <1000 USD per paper!
- In 2003, 2004, and 2006 the most productive astronomical observatory (in 2005 second after WMAP), as measured by the citation rate
- A new paradigm for astronomy: a large collaboration (>100 people) reminiscent of high-energy physics

Cool! What does SDSS measure and where do I get these data?

SDSS: Imaging and Spectroscopic Surveys

- **Imaging Survey:** the first large multi-color digital map of optical sky
 - 10,000 deg² (1/4 of the full sky; 20 TB of data)
 - 5 bands (ugriz: UV-IR), 0.02 mag photometric accuracy
 - < 0.1 arcsec astrometric accuracy
 - >100,000,000 stars and >100,000,000 galaxies
- **Spectroscopic Survey:** two multi-object fiber spectrographs on the same telescope. Each plate (radius of 1.49 degrees) can accommodate 640 fibers. Targets selected from imaging data: 1,000,000 galaxies, 100,000 quasars, 100,000 stars

Photometry

- **Magnitudes:** there are five different types! Aperture, fiber, psf, model and Petrosian magnitudes.
- **Radial Profiles:** all magnitudes are measured using circularized brightness profiles extracted for a predefined set of radii
- **Why do we need all these magnitudes?**

Photometry

- **Magnitudes:** we need different magnitudes because, depending on an object's brightness profile, they have different noise properties
- **Unresolved sources:** **aperture magnitudes** are the best, but only for bright stars; for a given error, **psf magnitudes** go 1-2 mags deeper; **fiber magnitudes** measure flux within 3 arcsec aperture, and thus estimate the flux seen by spectroscopic fibers
- **Resolved sources:** psf magnitudes don't include the total flux, actually none of the various magnitudes includes the total flux for resolved sources! **Petrosian magnitudes** include **the same** fraction of flux, independent of galaxy's angular size, however, they are very noisy for faint galaxies; **model magnitudes** have smaller noise for faint galaxies (especially if you are interested only in colors)

Photometry

- In the limit of a circular source, all fluxes (magnitudes) can be computed as:

$$flux(type) \propto \int p(x) \Phi_{type}(x) 2\pi x dx$$

- *type*: aperture, fiber, psf, Petrosian, model
- *p(x)*: circularized brightness profile
- $\Phi_{type}(x)$: type-dependent weight function
 - **aperture**: $\Phi(x) = 1$ for $x < 7.4$ arcsec, 0 otherwise
 - **fiber**: $\Phi(x) = 1$ for $x < 1.5$ arcsec, 0 otherwise
 - **psf**: $\Phi(x) = psf(x)$ for $x < 3$ arcsec, 0 otherwise, *photo* uses 2D integration (angle dependence)

- **Petrosian:** $\Phi(x) = 1$ for $x < R$ arcsec, 0 otherwise, R depends on the measured galaxy profile: defined by the ratio of the local surface brightness to the mean surface brightness within the same radius
- **model:** $\Phi(x)$ from a best-fit (deV or exp) 3-parameter pre-computed profile (convolved with seeing); must be 2D integration

Web Interfaces to SDSS Data Releases (www.sdss.org)

- [Catalog Archive Server \(CAS\)](#): search tools for querying the imaging and spectro catalogs from SDSS.
- [Spectro Query Server](#): search spectra by position, or by spectral or photometric parameters. Retrieve survey files.
- [Imaging Query Server](#): search photometry catalog by position, or by photometric parameters. Retrieve survey files.
- [Imaging cross-ID](#): find SDSS neighbors for a list of positions.
- [SQL search](#): search the db using your own SQL queries.

- [SpecList](#): upload (plate,fiber,MJD) list as part of an SQL query.
- [CasJobs](#): SQL searches with generous timeout setting.
- [Navigate](#): Point and click on SDSS images.
- [Finding charts](#): generate jpeg finding charts from SDSS images.
- [Image list](#): get jpeg cutouts of SDSS imaging for object lists.

Go to: <http://www.sdss.org/dr6/>

Example SQL queries

A color-color cut for, e.g., hot white dwarfs

```
-- flag cuts
declare @BRIGHT bigint      set @BRIGHT = dbo.fPhotoFlags('BRIGHT')
declare @SATURATED bigint   set @SATURATED = dbo.fPhotoFlags('SATURATED')
declare @bad_flags bigint   set @bad_flags = (@SATURATED | @BRIGHT)
-----
SELECT
    run, rerun, camcol, field, obj, colc, rowc, parentID, nChild,
    ra, dec, extinction_r,
    psfMag_u, psfMag_g, psfMag_r, psfMag_i, psfMag_z,
    psfMagErr_u, psfMagErr_g, psfMagErr_r, psfMagErr_i, psfMagErr_z
FROM
    star
WHERE
    -- check flags
    (flags & @bad_flags) = 0 and nchild = 0 and
    -- r magnitude cut
    psfMag_u > 14.0 and psfMag_u < 21.0 and
    -- hot WD color box
    (psfMag_u - extinction_u) - (psfMag_g - extinction_g) < 0.70 and
    (psfMag_g - extinction_g) - (psfMag_r - extinction_r) > -0.30
```

Everything around a given position

```
-- Flags --
declare @BRIGHT      bigint set @BRIGHT = dbo.fPhotoFlags('BRIGHT')
declare @SATURATED  bigint set @SATURATED = dbo.fPhotoFlags('SATURATED')
declare @MOVING      bigint set @MOVING = dbo.fPhotoFlags('DEBLENDED_AS_MOVING')
declare @bad_flags  bigint set @bad_flags = (@SATURATED | @BRIGHT | @MOVING)
declare @NODEBLEND  bigint set @NODEBLEND = dbo.fPhotoFlags('NODEBLEND')
declare @ISOLATED   varchar set @ISOLATED=(nchild = 0 and (flags & @NODEBLEND)=0)
-- Matching radius in deg
declare @matchRad float set @matchRad=10/60.0
-- Positions
declare @RA1 float set @RA1=205.871667
declare @Dec1 float set @Dec1=0.025833
-----
SELECT
    run, rerun, camcol, field, obj, colc, rowc, parentID, nChild,
    ra, dec, extinction_r,
    modelMag_u, modelMag_g, modelMag_r, modelMag_i, modelMag_z,
    modelMagErr_u, modelMagErr_g, modelMagErr_r, modelMagErr_i, modelMagErr_z
FROM
    photoTag
WHERE
    -- check flags
    (flags & @bad_flags) = 0 and nchild = 0 and
    -- proxy condition (note incomplete formula)
    (((ra-@RA1)*(ra-@RA1)+(@Dec1-dec)*(@Dec1-dec) < @matchRad)
```

Joining tables

```
--  
-- Get objects for POSS recalibration  
--  
declare @BRIGHT bigint      set @BRIGHT = dbo.fPhotoFlags('BRIGHT')  
declare @SATURATED bigint  set @SATURATED = dbo.fPhotoFlags('SATURATED')  
declare @MOVING bigint     set @MOVING = dbo.fPhotoFlags('DEBLENDED_AS_MOVING')  
declare @bad_flags bigint  set @bad_flags = (@BRIGHT | @SATURATED | @MOVING)  
declare @maglim float      set @maglim = 21.0  
-----  
SELECT  
    s.run, s.rerun, s.camcol, s.field, s.obj, s.colc, s.rowc, s.parentID, s.nChild,  
    ....  
    u.match, u.delta, u.angle, u.propermotion, u.blue, u.red  
FROM  
    star s, usno u  
WHERE  
    s.objID = u.objID and  
    -- Check flags  
    (flags & @bad_flags) = 0 and nchild = 0 and  
    -- Mag cut  
    psfMag_r < @maglim  
-----
```

More Complex Queries

See e.g. variability queries at

<http://www.astro.princeton.edu:81/sdss-archive/msg.1805.html>

or Appendix A in Sesar et al. 2008 (astro-ph/0808.2282)

Also, SQL is a standard language with good reference books...

Example: a single object at RA=18.87667 Dec=-0.86083

<http://cas.sdss.org/astrodr6/en/tools/chart/navi.asp>

Parameters

ra	18.87667 deg
dec	-0.86083 deg
opt	

Get Image 

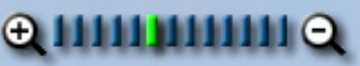

- Drawing options
- Grid
 - Label
 - Photometric objects
 - Objects with spectra
 - Invert Image
- Advanced options
- Spectroscopic
- Targets
- Outlines
 - Bounding Boxes
 - Fields
 - Masks
 - Plates

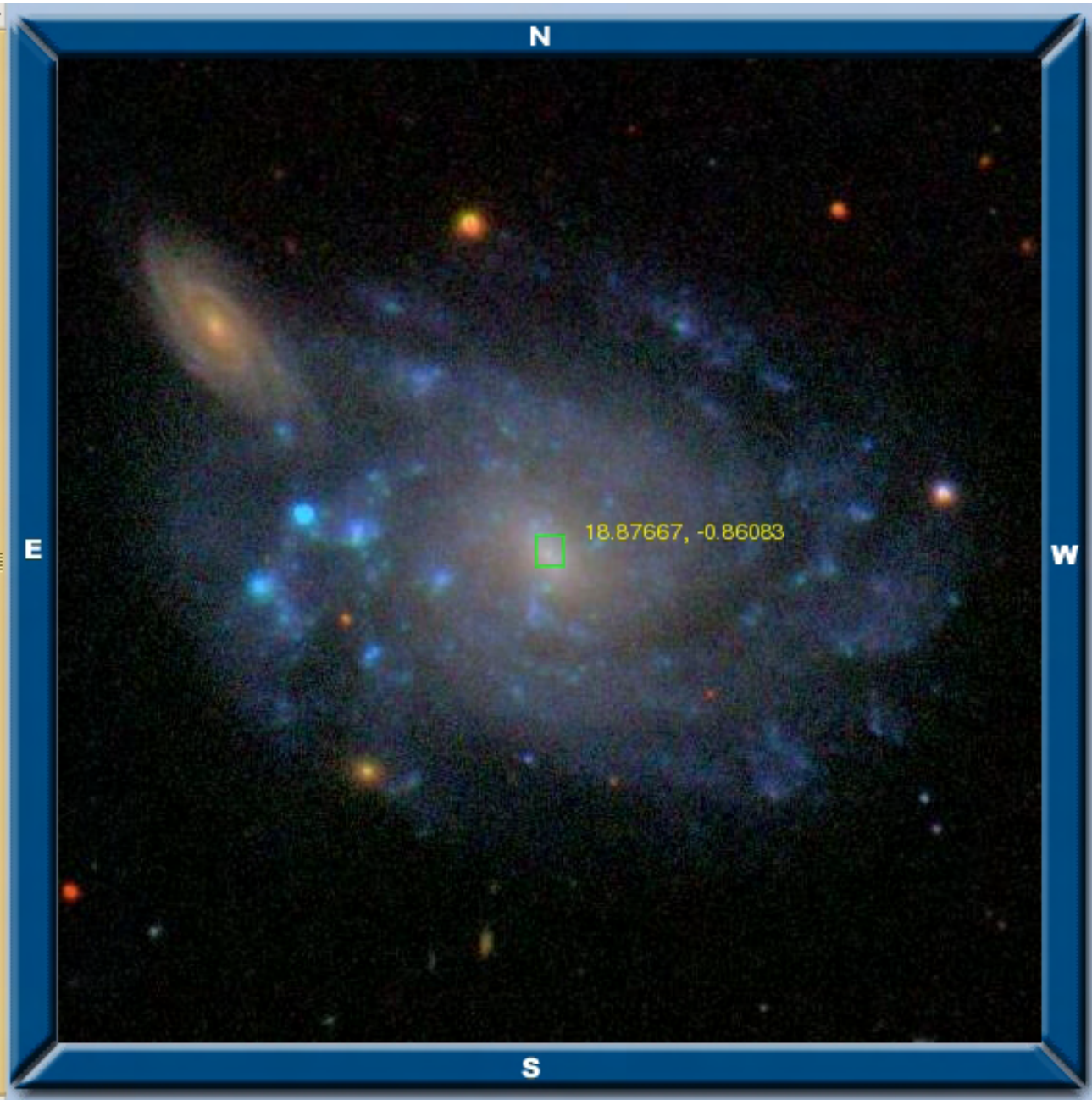

Selected object

ra	18.87684
dec	-0.86097
type	GALAXY
u	14.83
g	13.74
r	13.19
i	12.92
z	12.94



- Quick Look
- Explore
- Recenter
- Add to notes
- Show notes

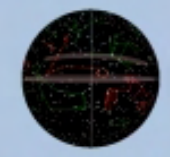

Click to open Sky Maps ?
To see Sky Maps, install the latest [Flash](#) and [Shockwave](#)

Parameters

ra	<input type="text" value="18.87667"/> deg
dec	<input type="text" value="-0.86083"/> deg
opt	<input type="text"/>

Get Image

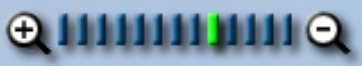

- Drawing options
- Grid
 - Label
 - Photometric objects
 - Objects with spectra
 - Invert Image
- Advanced options
- Spectroscopic Targets
 - Outlines
 - Bounding Boxes
 - Fields
 - Masks
 - Plates

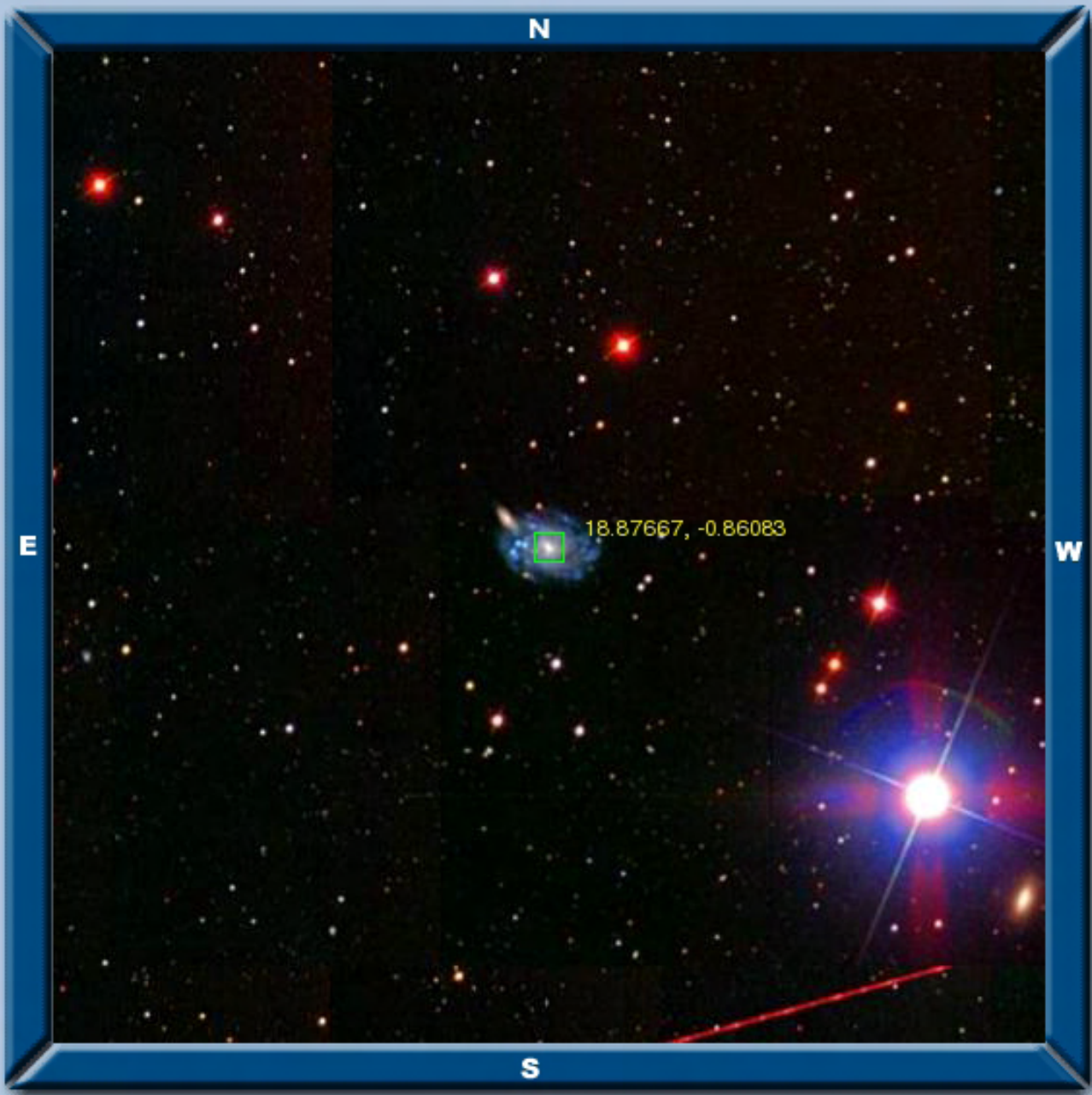

Selected object

ra	18.87684
dec	-0.86097
type	GALAXY
u	14.83
g	13.74
r	13.19
i	12.92
z	12.94



- Quick Look
- Explore
- Recenter
- Add to notes
- Show notes

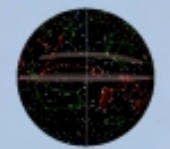

Click to open Sky Maps ?

To see Sky Maps, install the latest [Flash](#) and [Shockwave](#)

Parameters

ra	18.87667 deg
dec	-0.86083 deg
opt	

Get Image 

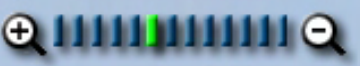

- Drawing options
- Grid
 - Label
 - Photometric objects
 - Objects with spectra
 - Invert Image
- Advanced options
- Spectroscopic
- Targets
- Outlines
 - Bounding Boxes
 - Fields
 - Masks
 - Plates

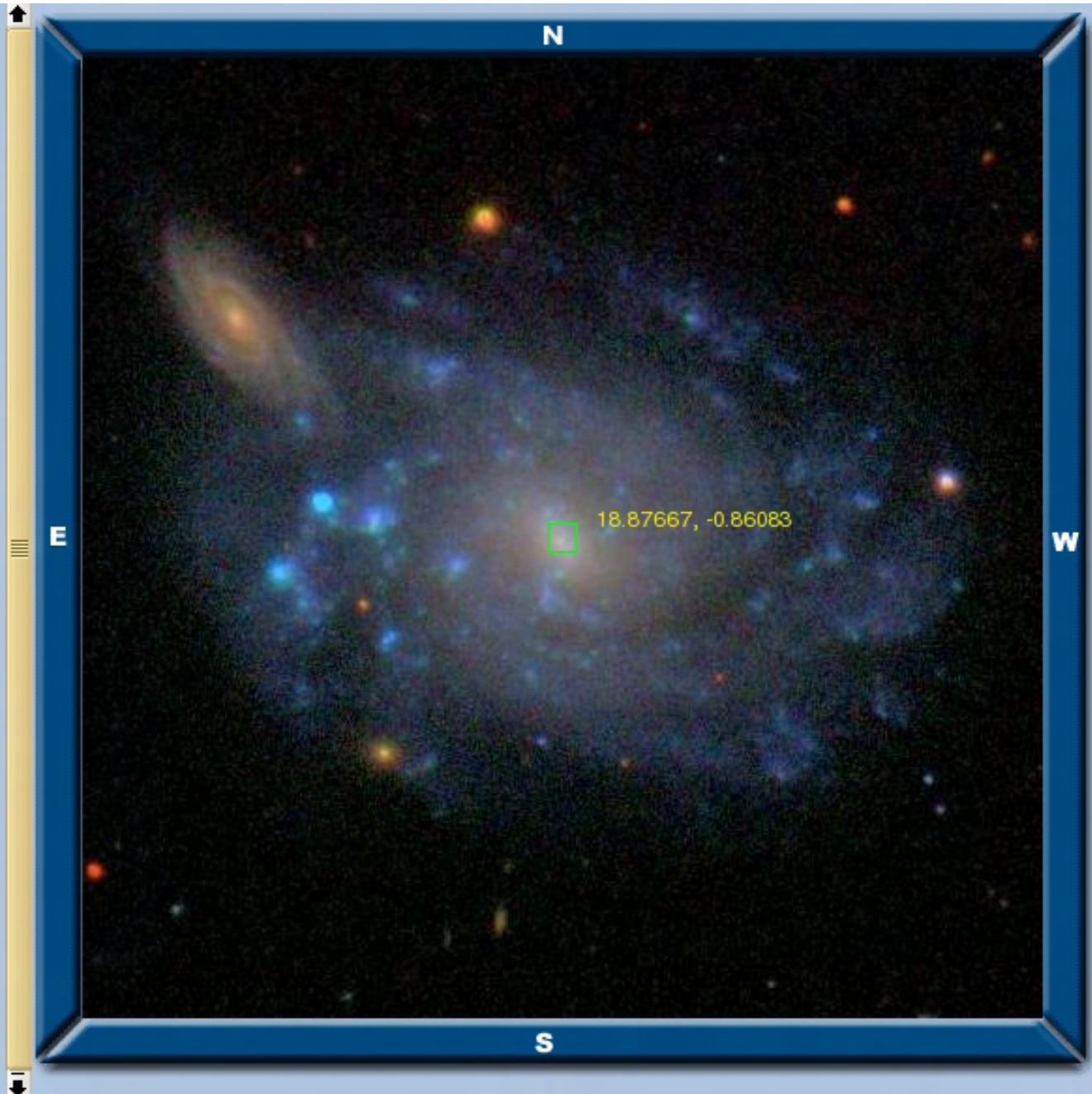

Selected object

ra	18.87684
dec	-0.86097
type	GALAXY
u	14.83
g	13.74
r	13.19
i	12.92
z	12.94



- Quick Look
- Explore
- Recenter
- Add to notes
- Show notes

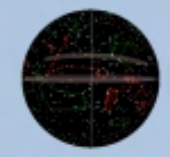

Click to open Sky Maps ?
To see Sky Maps, install the latest [Flash](#) and [Shockwave](#)

Parameters

ra: deg

dec: deg

opt:

Get Image



Drawing options

Grid

Label

Photometric objects

Objects with spectra

Invert Image

Advanced options

Spectroscopic Targets

Outlines

Bounding Boxes

Fields

Masks

Plates

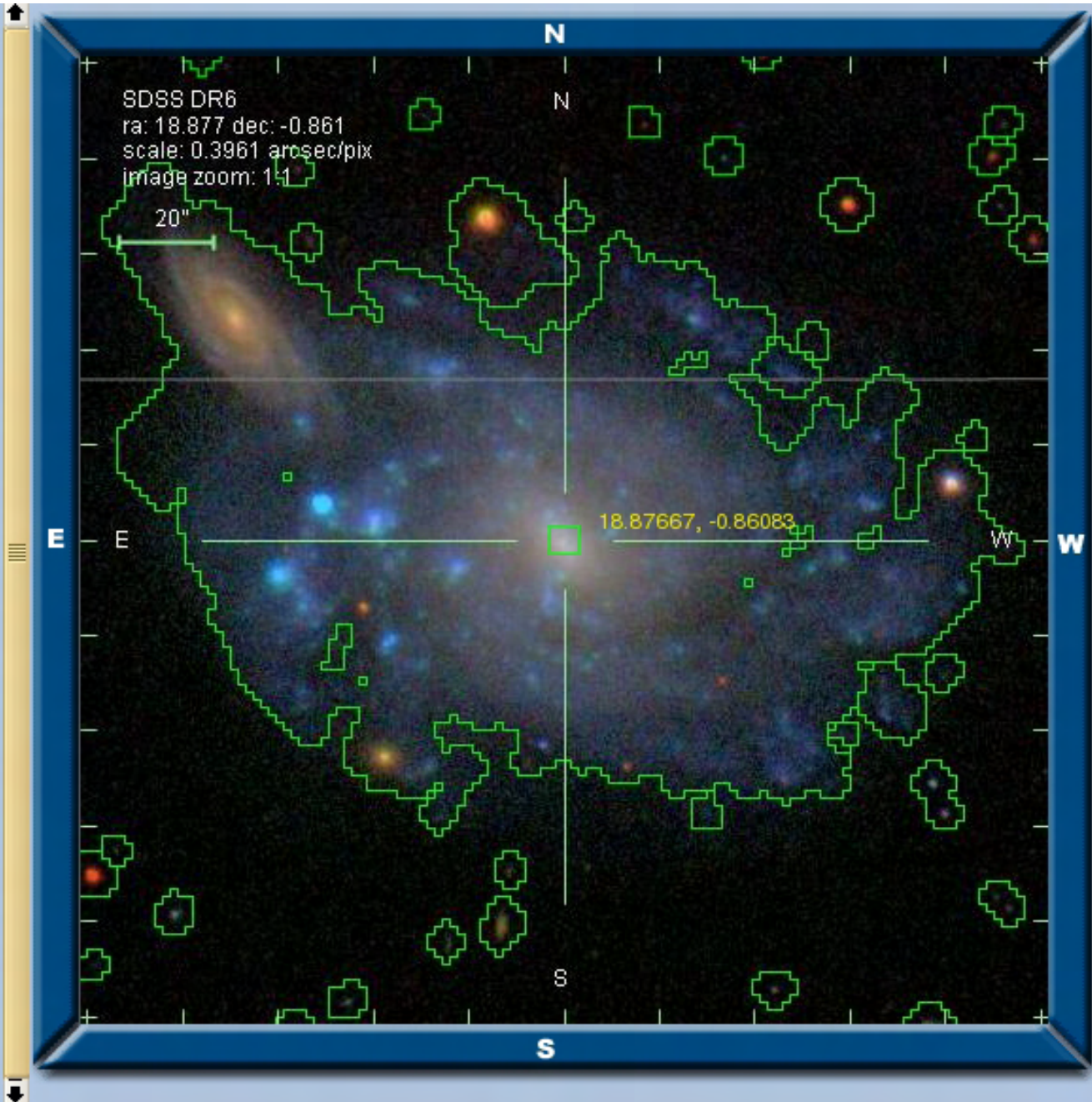

Selected object

ra	18.87684
dec	-0.86097
type	GALAXY
u	14.83
g	13.74
r	13.19
i	12.92
z	12.94



- Quick Look
- Explore
- Recenter
- Add to notes
- Show notes

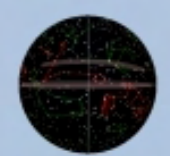

Click to open Sky Maps ?
 To see Sky Maps, install the latest [Flash](#) and [Shockwave](#)

Lecture II

1. Solar System

- Main-belt asteroids
- Trojans, KBOs, comets

2. Stars

- Colors vs. Spectra
- Main-sequence vs. Other

3. the Milky Way

- Distribution in position-velocity-metallicity space
- Substructure

Solar System Science with SDSS

- Introduction
- Main-Belt Asteroids
- Jovian Trojans
- Outer Solar System
- Comets
- Near-Earth Objects



Asteroids as seen from spacecrafts

What is the significance of ground based asteroid studies in an era when spacecrafts can obtain such breathtaking photographs?

The answer is simple; the SDSS asteroid observations provide

- A sample 100,000 times larger than the one shown in previous figure: statistical analysis
- Five-color images, rather than black-and-white images
- Sensitivity to detect asteroids smaller than the smallest craters visible on the four objects in previous figure

SDSS Asteroid Observations

Moving objects in Solar System can be efficiently detected out to ~ 20 AU even in a single scan: 5 minutes between the exposures in the r and g bands is sufficient to detect motion.

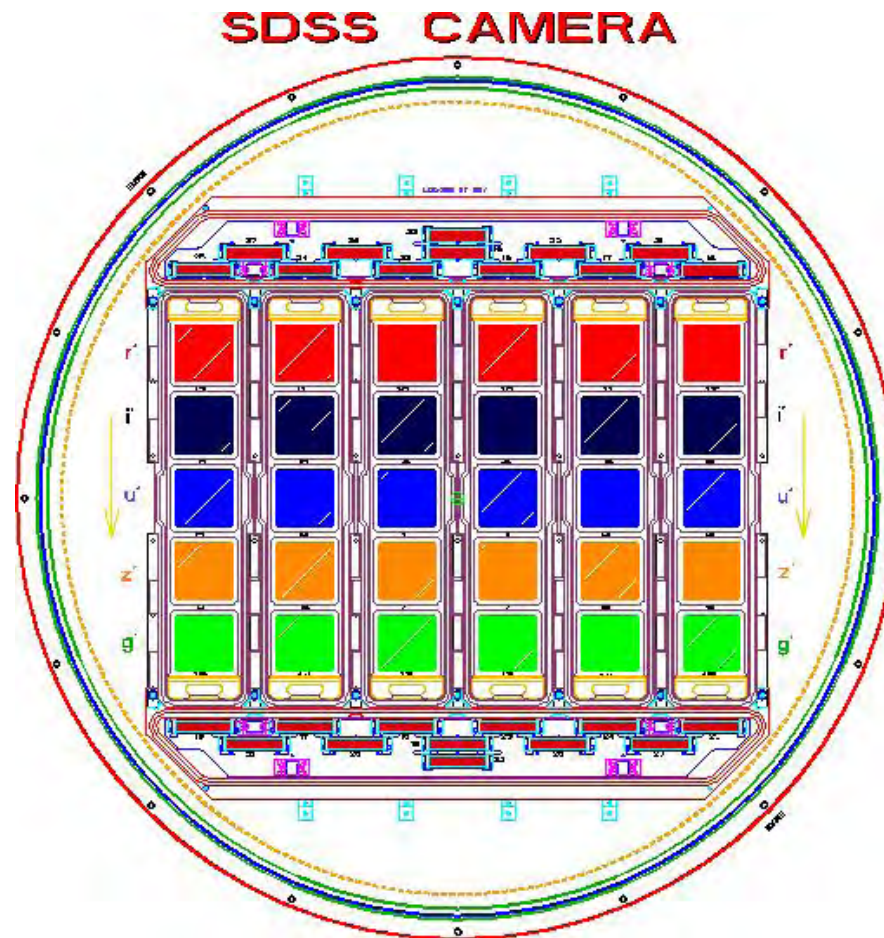



Asteroids move during 5 minutes and thus appear to have peculiar colors.

The images map the i-r-g filters to RGB. The data is taken in the order riuzg, i.e. GR..B.

SDSS Asteroid Observations

- Moving objects must be efficiently found to prevent the contamination of quasar candidates (and other objects with non-stellar colors) for spectroscopic follow-up.
- The sample completeness is 95%, with a contamination of 5%, to several magnitudes fainter completeness limit than available before
- The velocity errors 2-10%, sufficient for a recovery within a few weeks (and for estimating heliocentric distance within 5-10%)
- Accurate (~ 0.02 mag) 5-band photometry
- **SDSS Moving Object Catalog 4 is public at www.sdss.org**

Cataloged $\sim 500,000$ moving objects, $\sim 200,000$ are identified with previously known objects, $\sim 100,000$ are unique

Main SDSS Asteroid Results

COMPARISON OF ASTEROID SIZE DISTRIBUTION: OBSERVATIONS AND MODELS

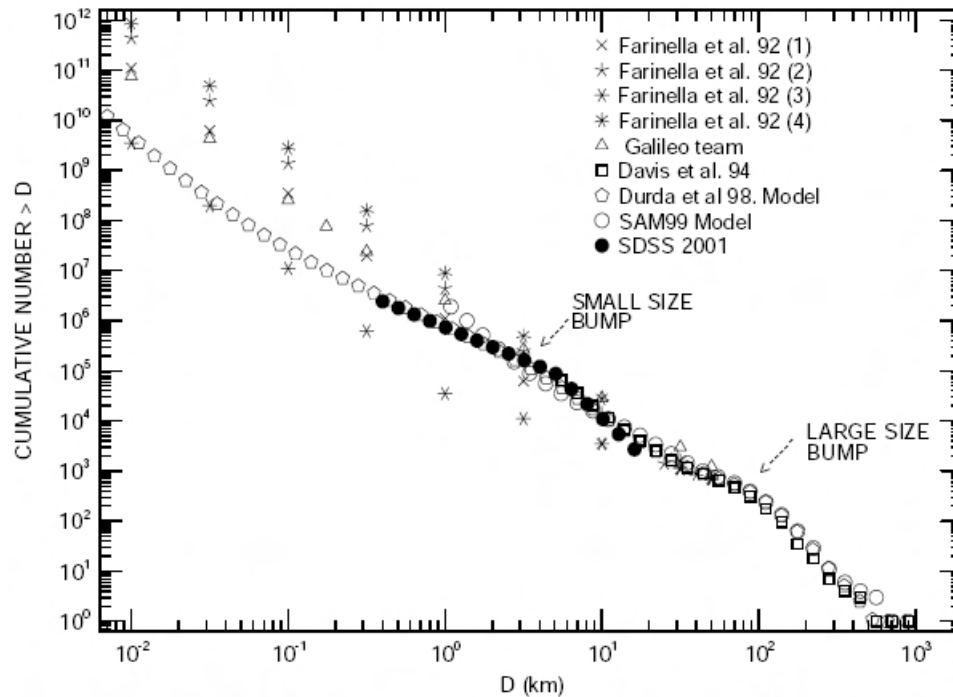

(Davis 2002)

- **The size distribution for main-belt asteroids:**

- measured to a significantly smaller size limit (< 1 km) than possible before: discovery of **a change of slope** at $D \sim 5$ km
- **a smaller number of asteroids** compared to previous work by a factor of ~ 2 ($N(D > 1\text{km}) \sim 0.75$ million)

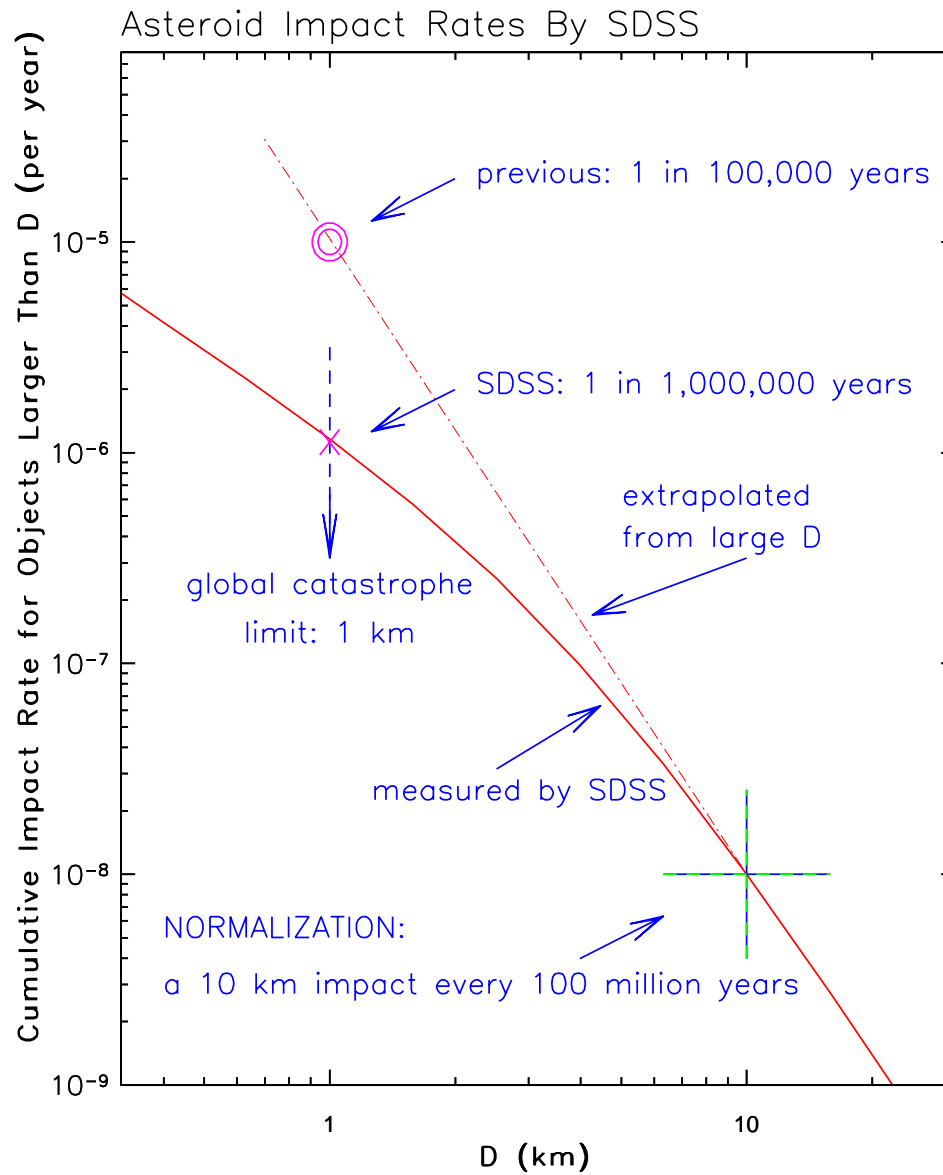

The impact rate for $D > 1$ km: **once in a million years**

Main SDSS Asteroid Results

- **The size distribution for main-belt asteroids** (encodes collisional history and size-strength relationship)
- **Strong correlation between colors and position/dynamics:**
Confirmation of color gradient: rocky S-type in the inner belt vs. carbonaceous C type asteroids in the outer belt; dynamical families have distinctive colors;

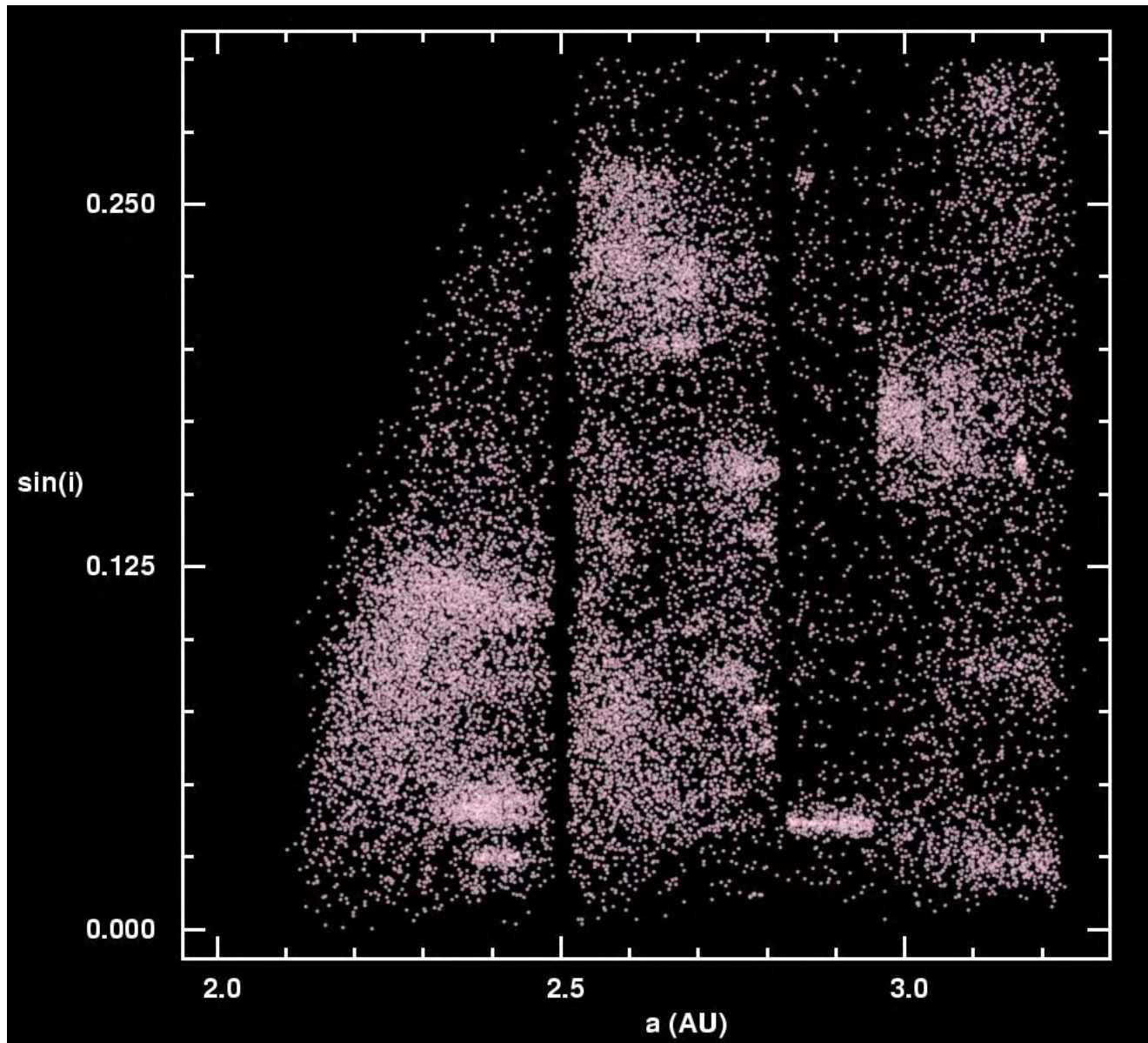

The semi-major axis $v.$ (proper) inclination for asteroids with known orbits that were observed by SDSS

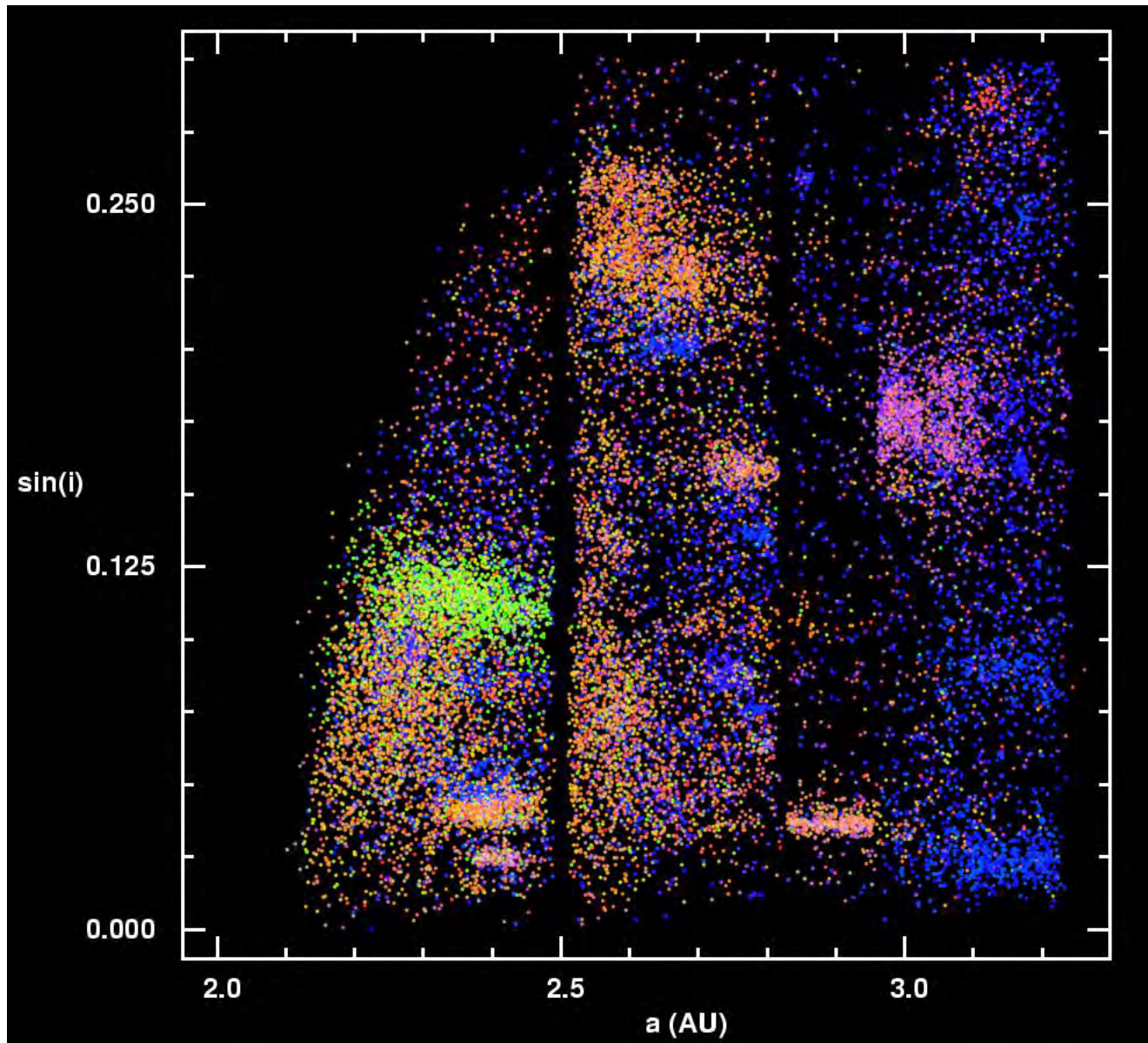

The semi-major axis v. (proper) inclination for known asteroids color-coded using **measured** SDSS colors

What is the meaning of different color shades?

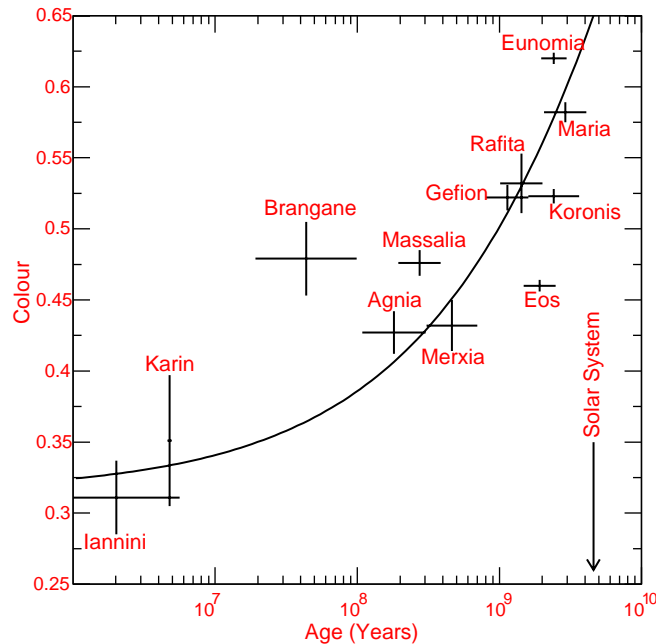

SDSS Colour vs. Age for S type asteroids

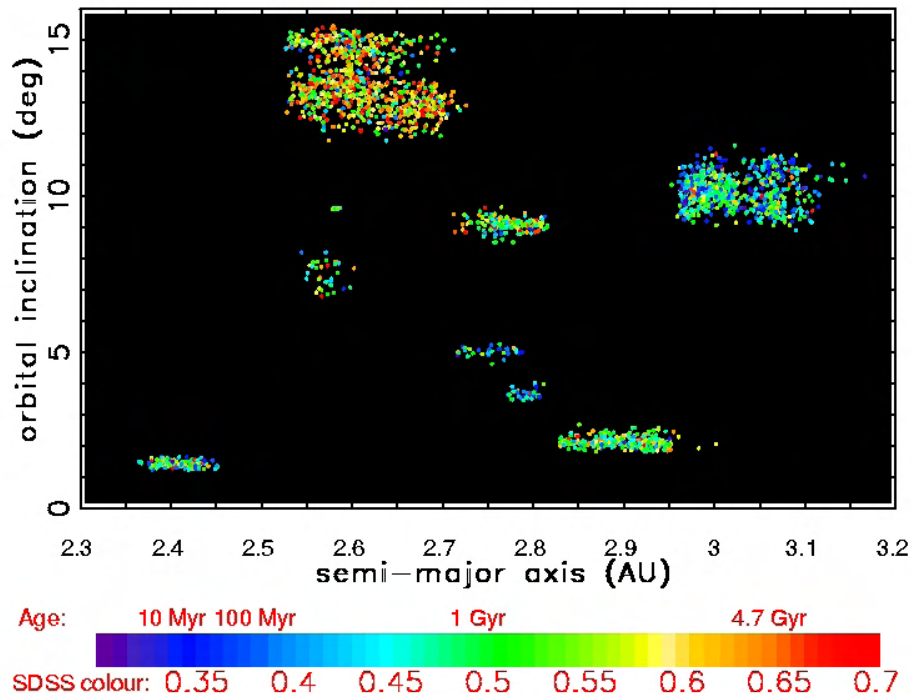

- Chemistry, of course, for the gross differences (red vs. blue), but what about different shades of red or blue?
- Family ages can be estimated using dynamics
- Within a given chemical class, colors depend on age: **SDSS colors can be used to date asteroids**
- **Space weathering:** the first in situ measurement of its rate
- **Solves the puzzle of mismatched colors between meteorites and asteroids**

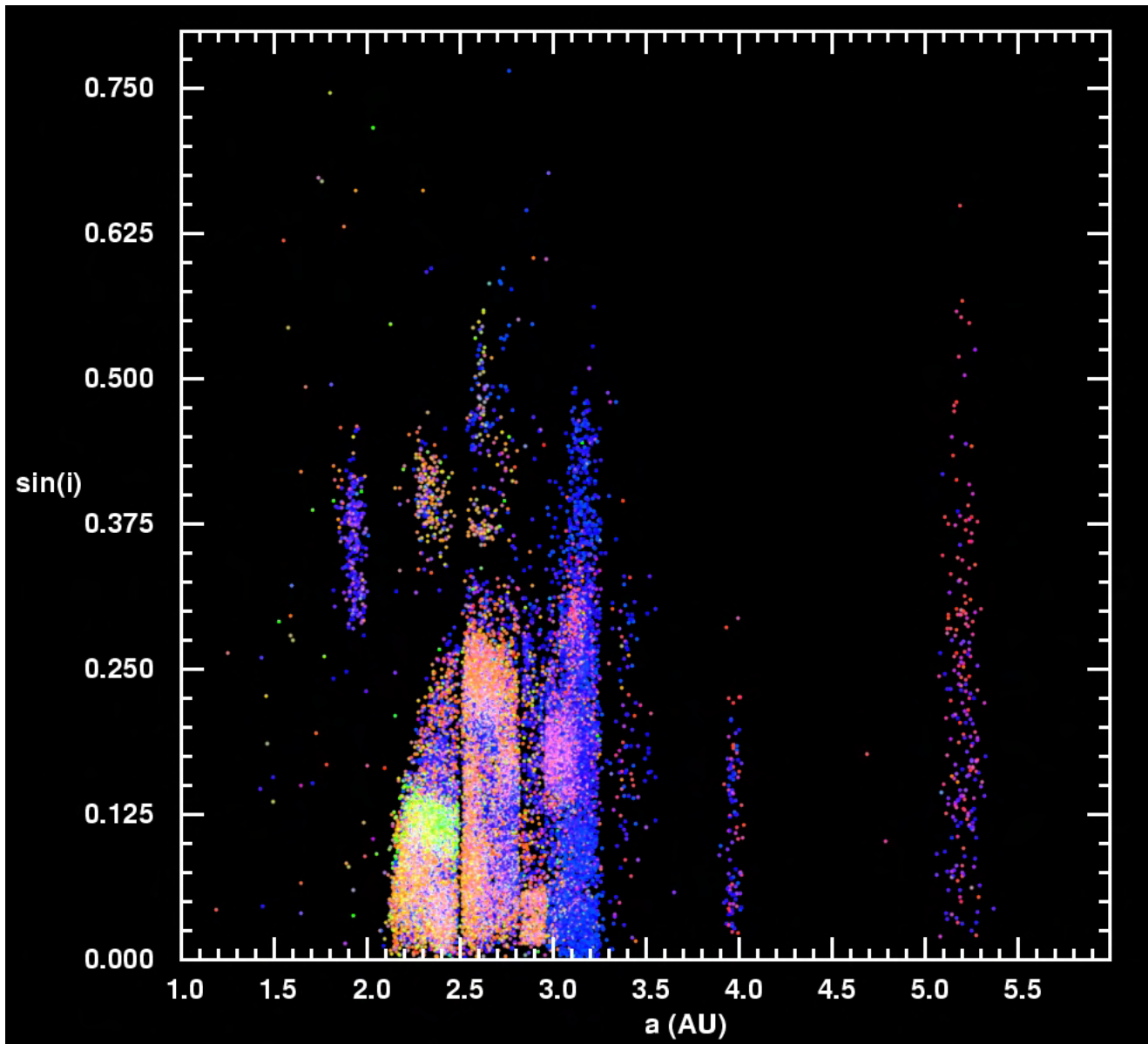

The osculating inclination vs. semi-major axis diagram.

The Properties of Jovian Trojan Asteroids

- There are (1.6 ± 0.1) more objects in the leading swarm: long suspected, but proven by SDSS (due to a large sample and well understood selection effects)

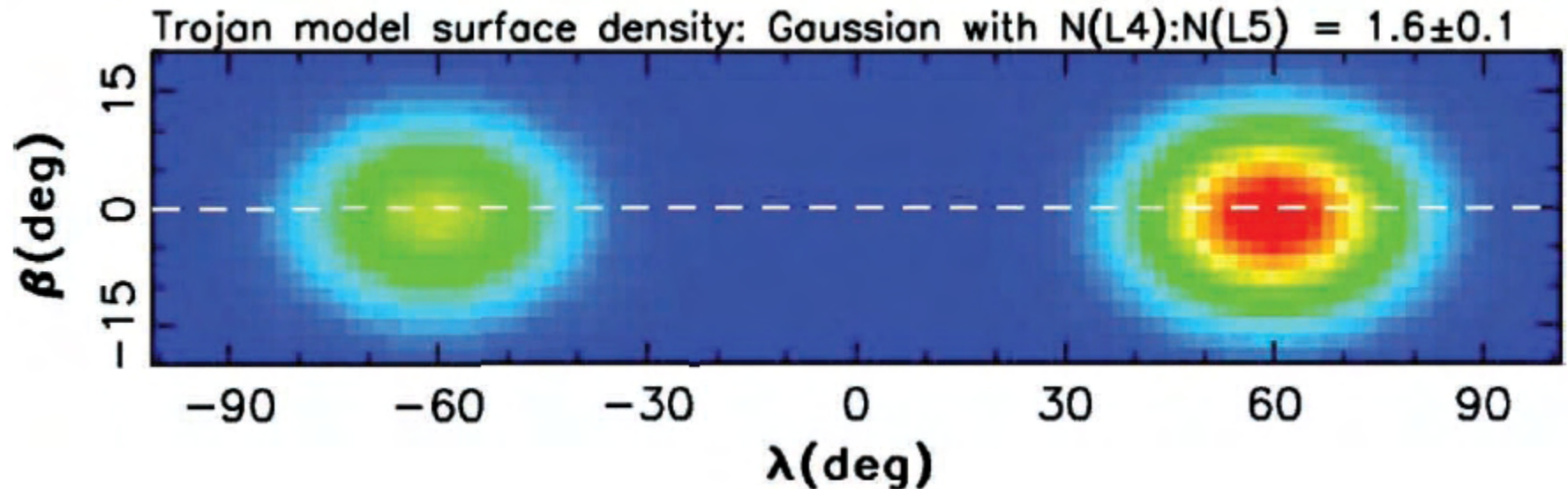

The Properties of Jovian Trojan Asteroids

- There are (1.6 ± 0.1) more objects in the leading swarm
- Trojans' color depends on orbital inclination (families?)
- The leading and trailing swarm have different color distributions
- A break in the size distribution, similar to the main belt, but with a larger characteristic size (~ 40 km)
- Down to the same size limit, there are as many Trojan asteroids as main-belt asteroids!

Outer Solar System

(Becker et al.)

2006 SQ372 : $a = 811.0 \pm 254.2$

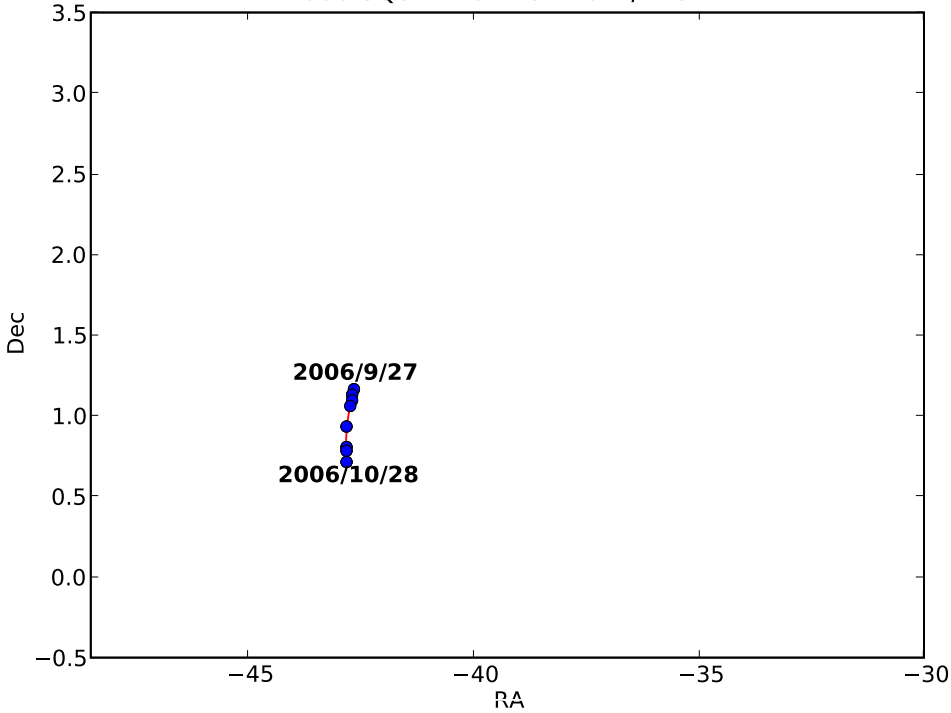

2006 SQ372 : $a = 795.7 \pm 2.8$

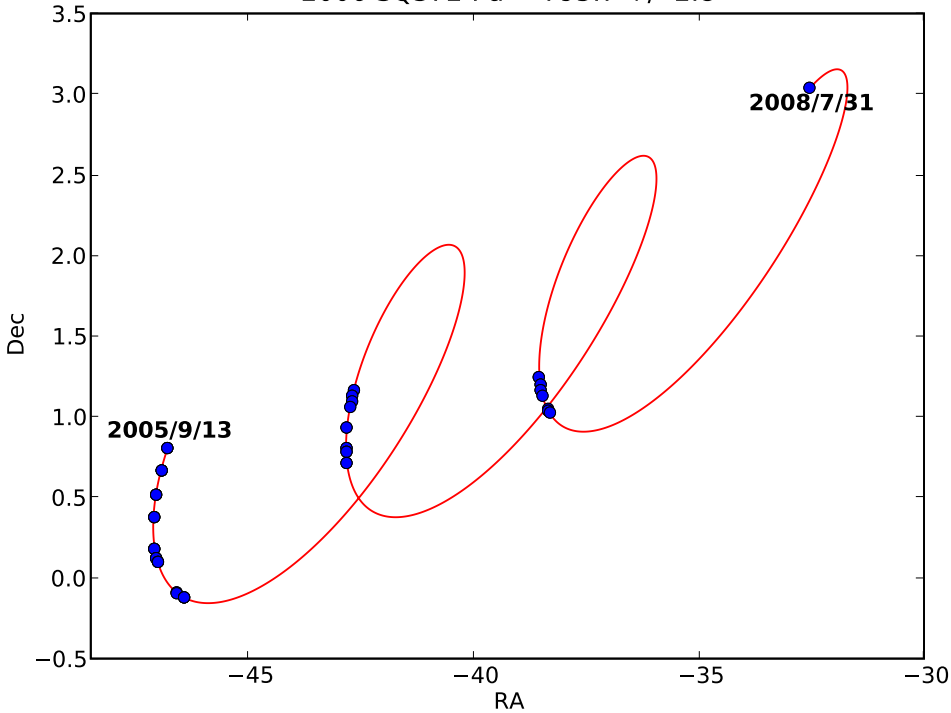

- Single epoch data not good enough, need multi-epoch data: stripe 82 and SDSS-II SN survey
- Used proto-LSST software to link observations
- Discovered 2 (out of 6 known) Neptunian Trojans
- Discovered ~ 50 Kuiper belt objects
- **2006 SQ 372**: the most interesting object with a semi-major axis of ~ 800 AU!
- **Simulations strongly suggest that this object was recently scattered into inner Solar System from Oort cloud!**
- **Exciting, but we need deeper data to get large samples!**

The Legacy of SDSS:

- Over 100 times larger sample with accurate color measurements: taxonomy almost as good as that from spectroscopy
- Faint flux limit: surprises in size distribution
- Well understood selection effects: surprises from Jovian Trojans
- Stripe 82: a demonstration of next-generation linking codes and a hint of future discoveries beyond Kuiper Belt

Future discoveries from: SkyMapper, Pan-STARRS, DES, LSST

Stars in SDSS

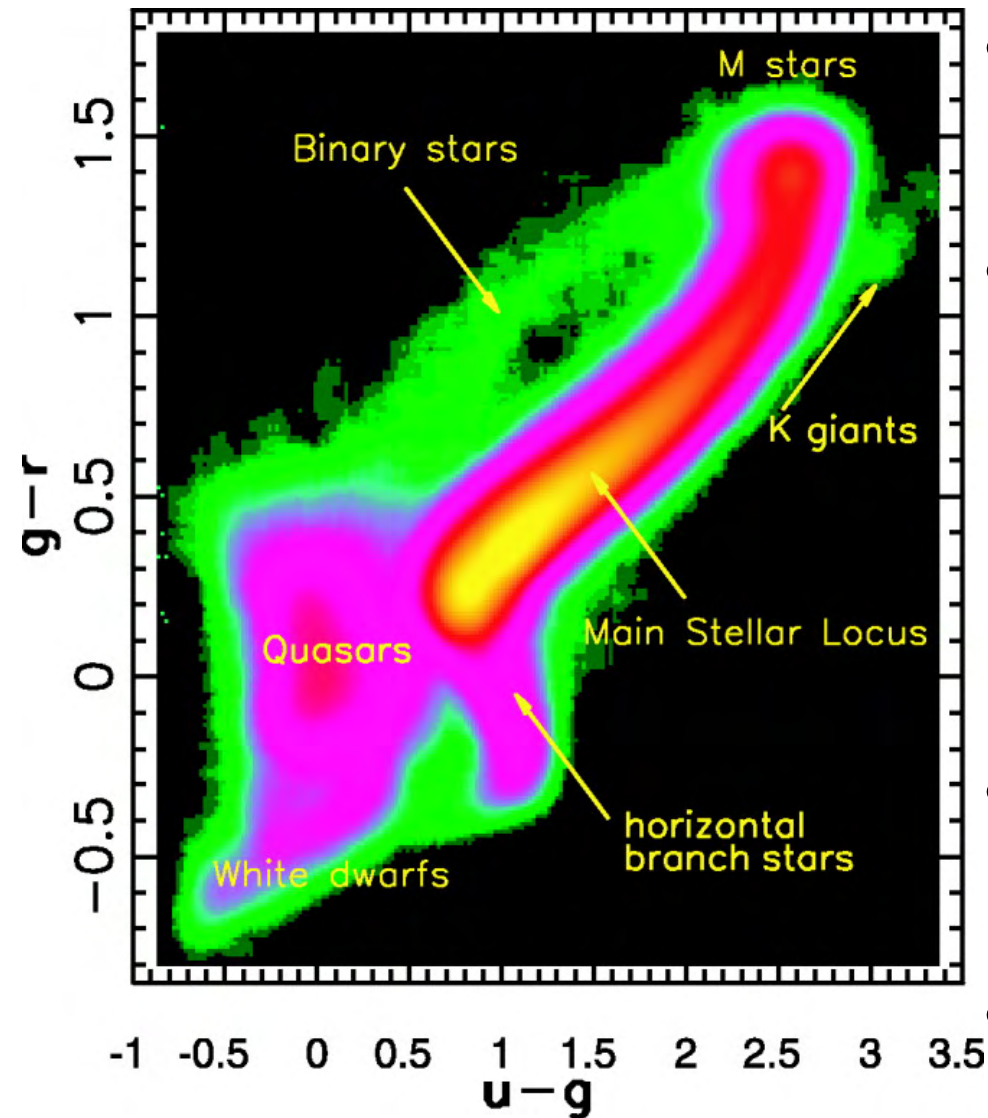

Wide wavelength coverage, and accurate and robust photometry

- Stars on the main stellar locus are dominated ($\sim 98\%$) by main sequence stars (below $r \sim 14$)
- The position of main sequence stars on the locus is controlled by their spectral type/effective temperature/luminosity, and thus can be used to estimate distance: photometric parallax method for ~ 50 million stars
- Accurate $u-g$ color enables photometric metallicity estimates for 6 million SDSS F/G stars
- **“Very interesting” stars are selected for spectroscopic follow-up**

SDSS sources

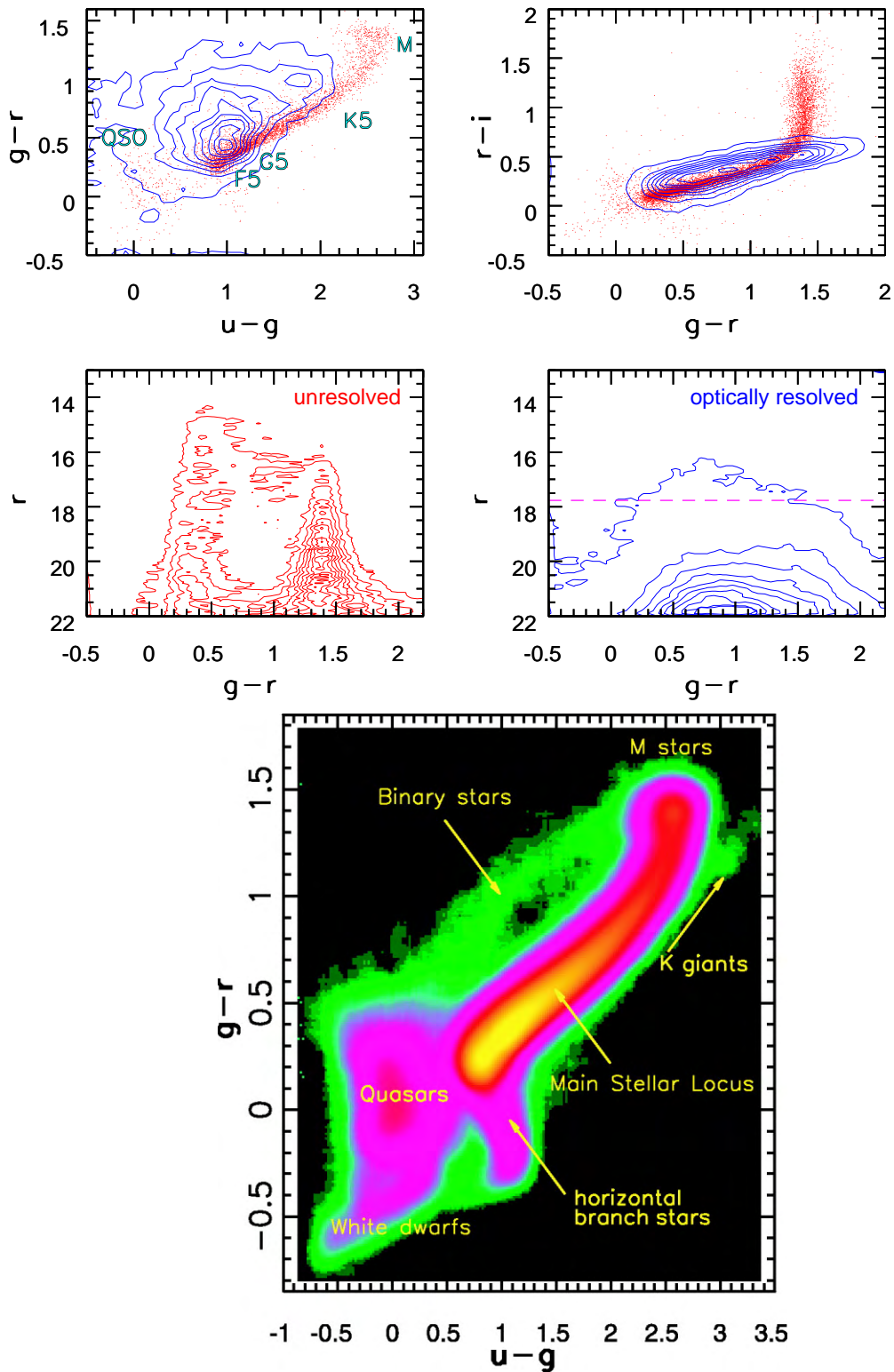

Spectroscopic Targets:

- **Galaxies:** simple flux limit for “main” galaxies, flux-color cut for luminous red galaxies (cD)
- **Quasars:** flux-color cut, matches to FIRST survey
- **Non-tiled objects (color-selected):** calibration stars (16/640), interesting stars (hot white dwarfs, brown dwarfs (tiled), red dwarfs, C stars, CV, BHB, PN stars), sky

SDSS Data Release 5 (public): 675,000 galaxies, 90,000 quasars, 155,000 stars.

Spectroscopic Data and Processing

- **Spectra:** Wavelength coverage: 3800–9200 Ang, Resolution: 1800, Signal-to-noise: >4 per pixel at $g=20.2$: *These spectra have much better quality than needed for a redshift survey of galaxies*; they are publicly available in a user-friendly format through an exquisite web interface at www.sdss.org
- **Automated Pipelines:**
 - *target*: target selection and tiling
 - *spectro2d*: Extraction of spectra, sky subtraction, wavelength and flux calibration, combination of multiple exposures: end result is $F_\lambda(\lambda)$
 - *spectro1d*: Uses $F_\lambda(\lambda)$ for object classification, redshifts determination, measures line strengths and line indices.

The Utility of SDSS Stellar Spectra

1. **Calibration** of observations (e.g. can synthesize photometry with an accuracy of ~ 0.04 mag)
2. More accurate and robust **source identification** than based on photometric data alone: e.g. confirmation of unresolved binaries, low-metallicity stars, cold white dwarfs, L and T dwarfs, C stars, CVs, etc.
3. Accurate **stellar parameters estimation** (T_{eff} , $\log(g)$, metallicity, detailed chemical composition)
4. **Radial velocity** for kinematic studies of the Milky Way (especially useful when combined with proper motions)

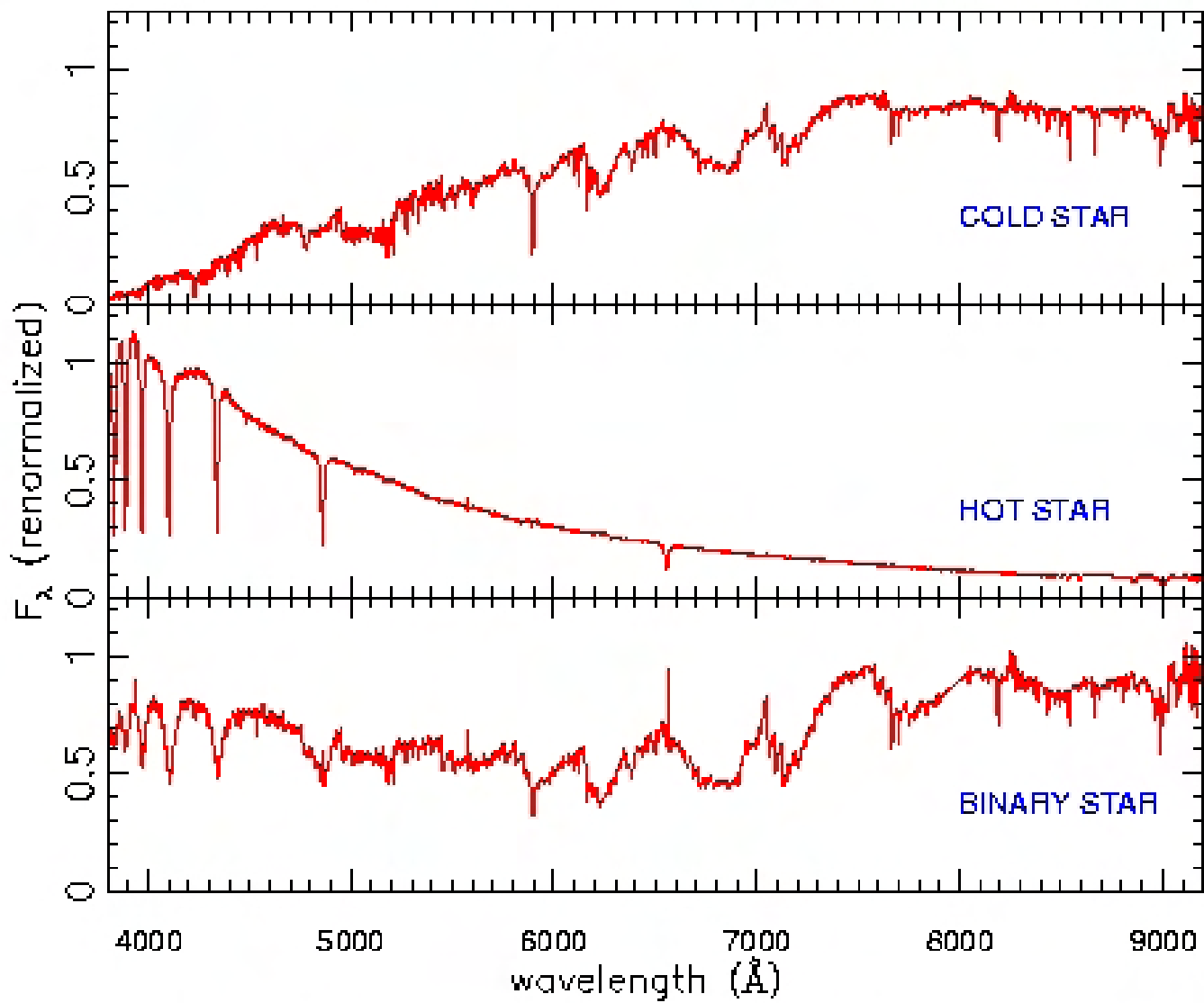

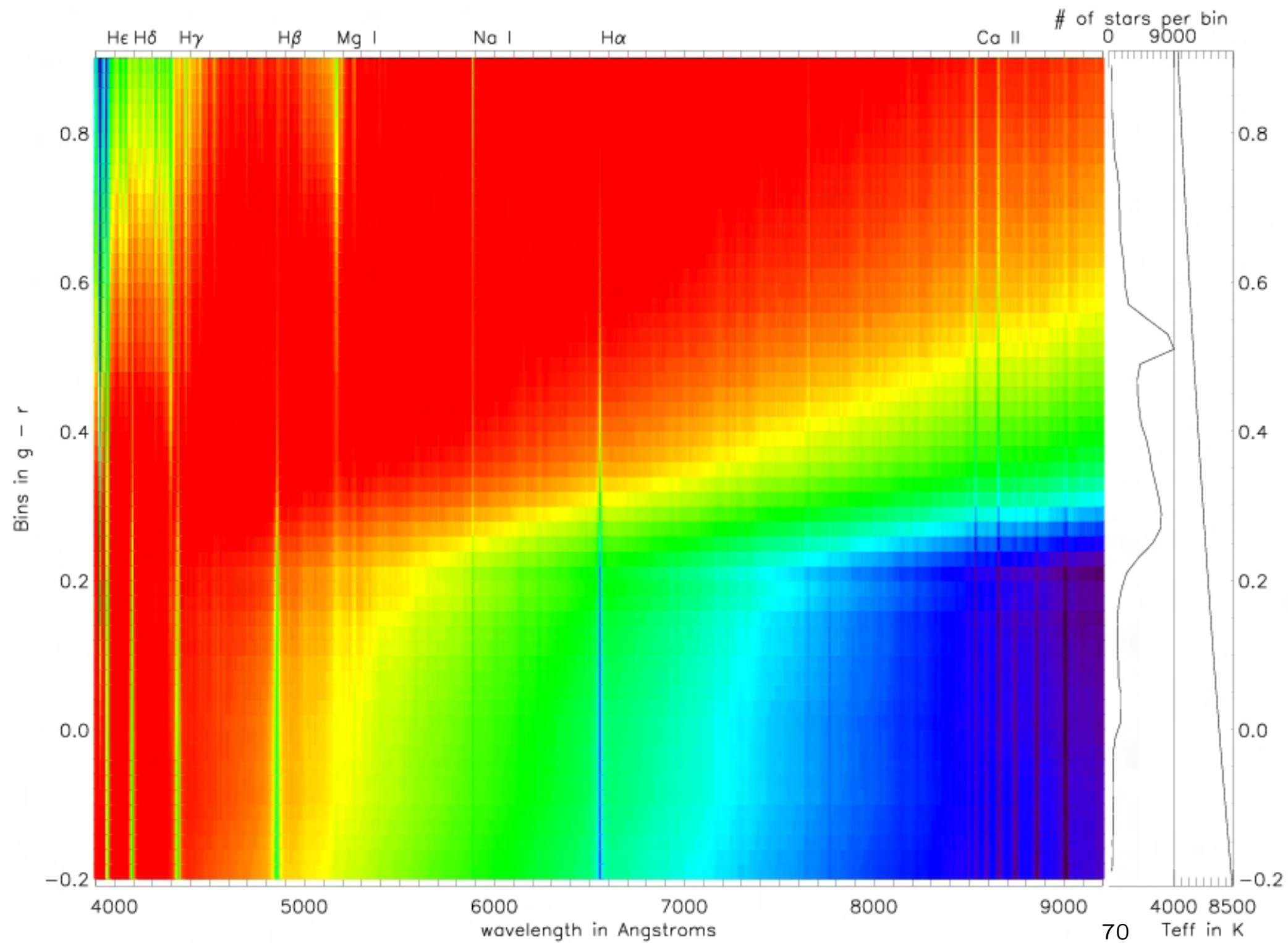

Source Identification

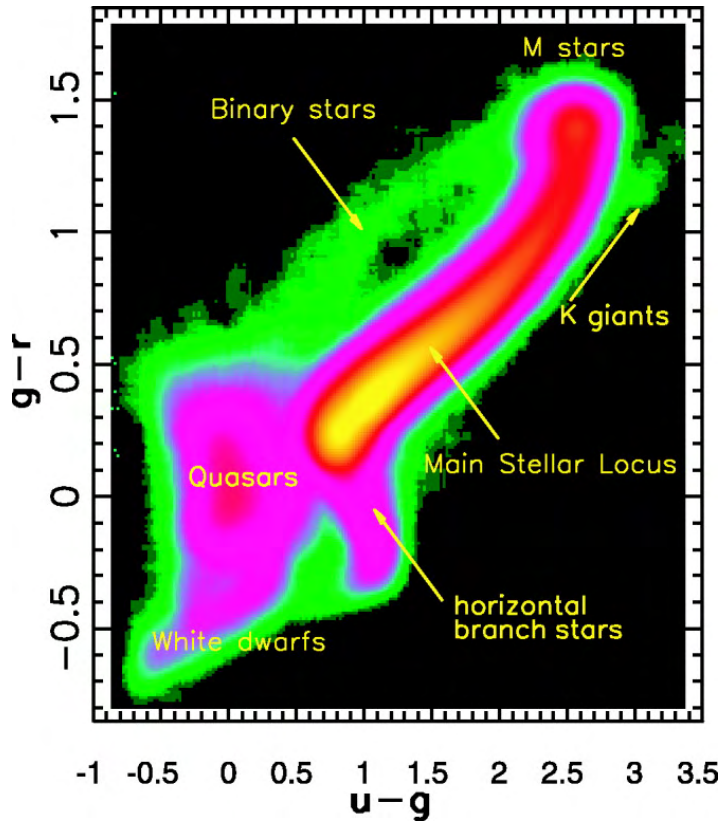

- Stellar spectroscopic targets are color-selected, as illustrated in the **top left** figure
- A spectrum is required to secure a robust identification, as well as for a detailed measurement of the source properties
- **Bottom left:** an example of a C star: SDSS has discovered 95% of all known dwarf C stars (Margon et al. 2006)
- **Bottom right:** an example of an L dwarf (SDSS has discovered the first known field T dwarf, Strauss et al. 2000)

RA=192.95779, DEC= 1.50051, MJD=52024, Plate= 522, Fiber= 4

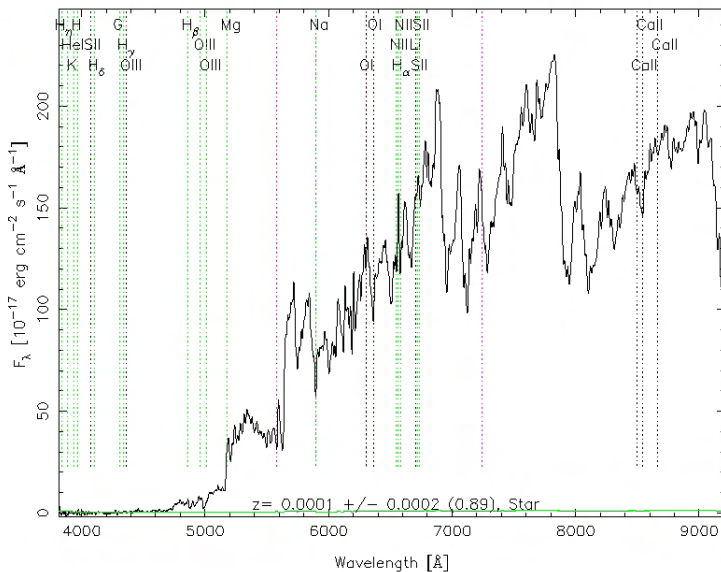

RA=162.17848, DEC= 1.19958, MJD=51910, Plate= 275, Fiber=575

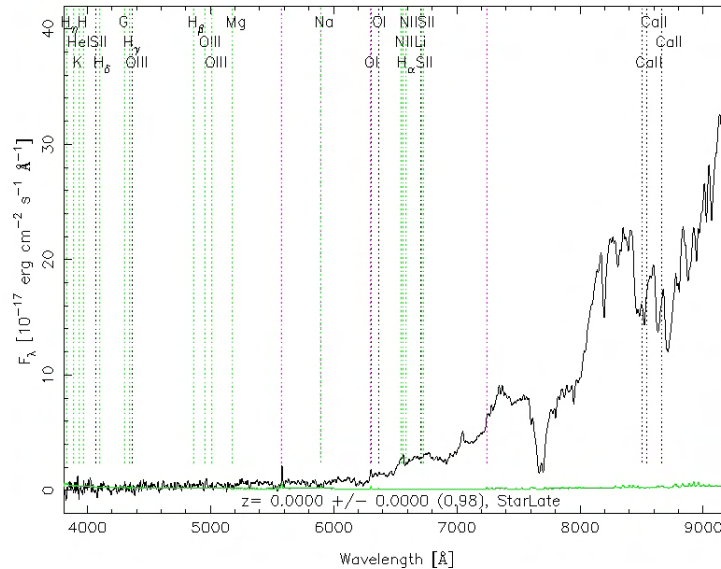

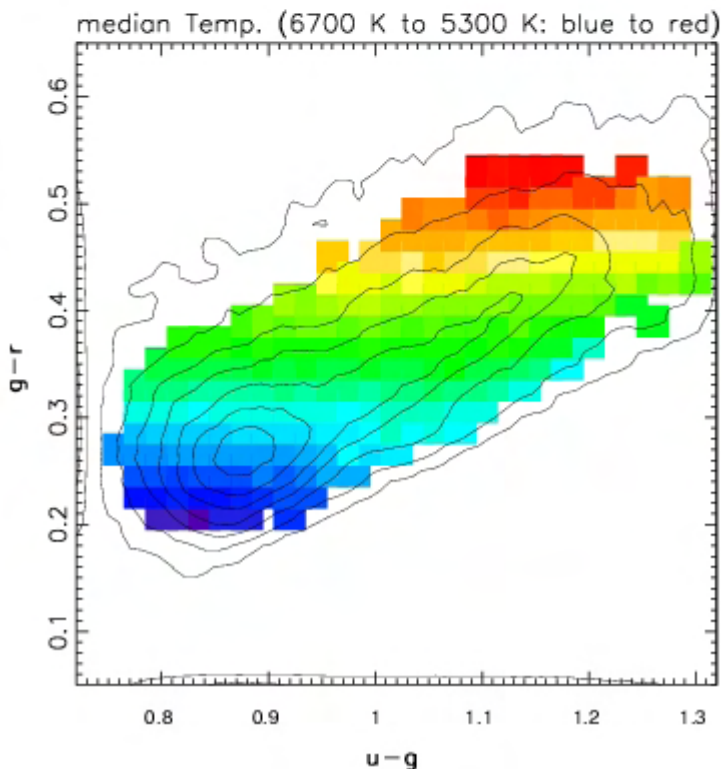
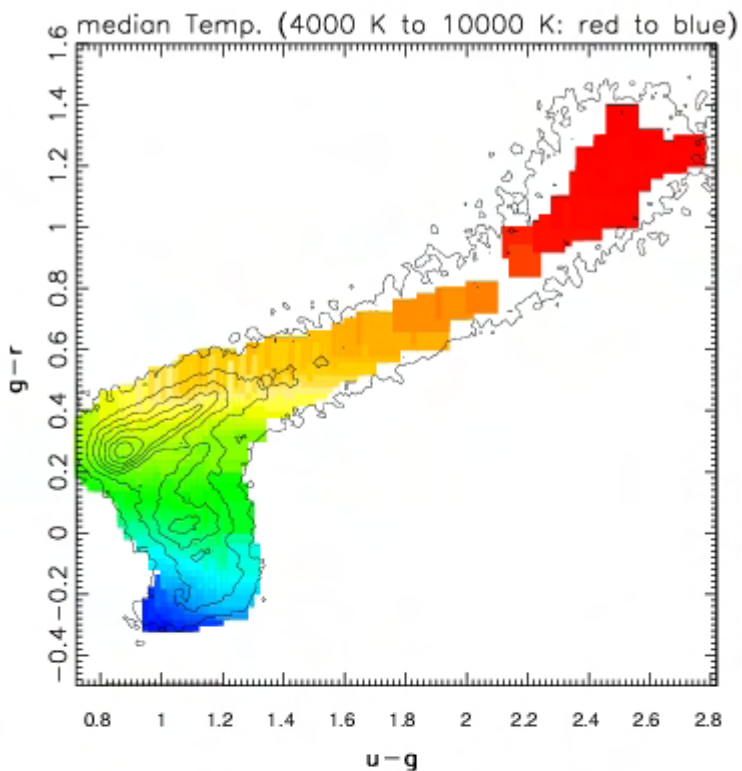

Stellar Parameters Estimation

- SDSS stellar spectra are of sufficient quality to provide robust and accurate stellar parameters such as effective temperature, gravity, metallicity, and detailed chemical composition (c.f. poster by T. Beers)
- Stellar parameters estimated from spectra show a good correlation with colors measured from imaging data
- **Top left:** the median effective temperature as a function of the position in the $g - r$ vs. $u - g$ diagram (from 4000 K to 10,000 K, red to blue)
- **Bottom left:** zoomed-in version of the top left figure
- **Photometric estimate of effective temperature:** T_{eff} determines the $g - r$ color, but has negligible impact on the $u - g$ color

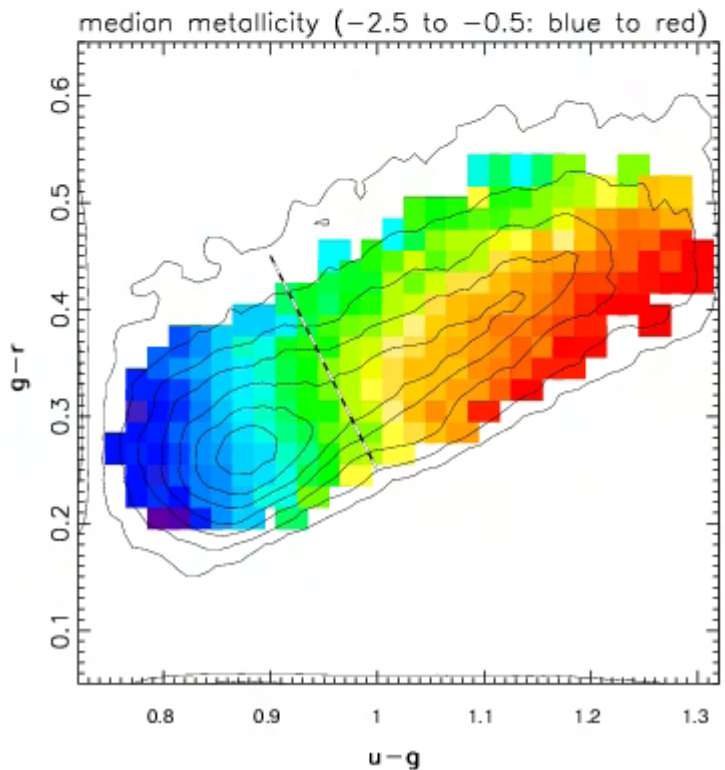
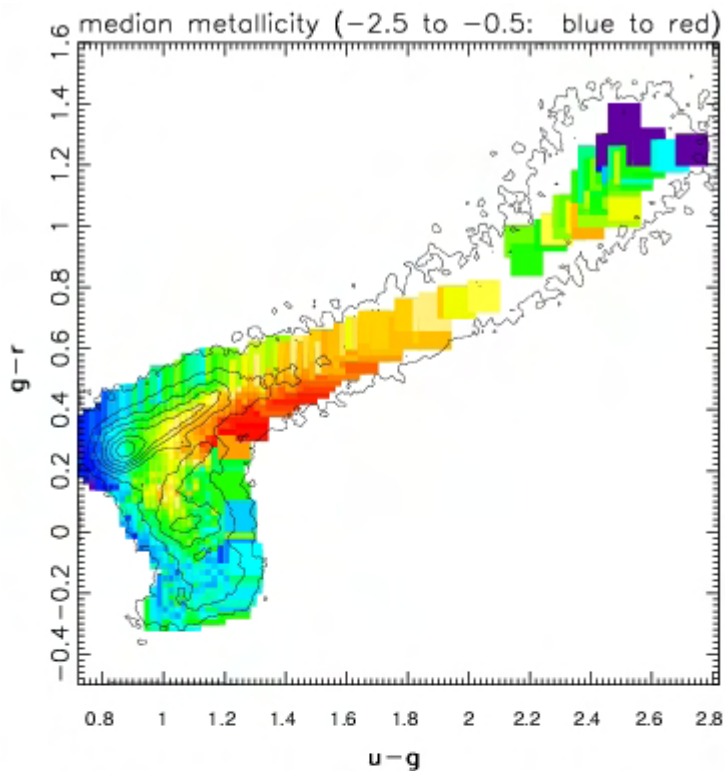

Stellar Parameters Estimation

- Stellar parameters estimated from spectra show a good correlation with colors measured from imaging data
- **Top left:** the median metallicity as a function of the position in the $g-r$ vs. $u-g$ diagram (from -0.5 to -2.5 , red to blue)
- **Bottom left:** zoomed-in version of the top left figure
- **Photometric estimate of metallicity:** can be determined with an error of ~ 0.3 dex (relative to spectroscopic estimate) from the position in the $g-r$ vs. $u-g$ color-color diagram using simple expressions
- **This finding is important for studies based on photometric data alone, and also demonstrates the robustness of parameters estimated from spectroscopic data**

Classical Decomposition of the Milky Way Components

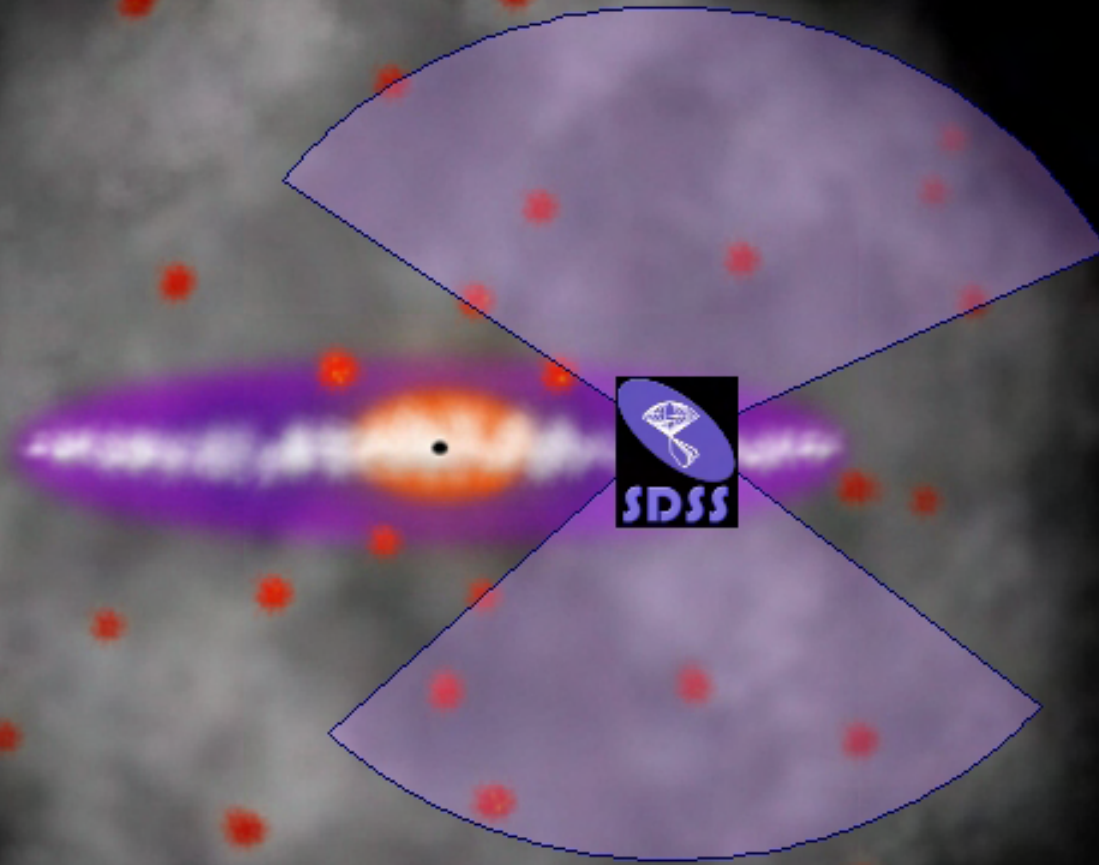

- Thin/thick disk
- Galactic bulge
- Stellar halo

- Components trace the DM dominated potential

- They are a product of Milky Way formation and evolution

Galaxy Formation Scenarios (abridged)

The ELS Monolithic Collapse Model

- The ELS model (Eggen, Lynden-Bell and Sandage, 1962): the Milky Way formed from the rapid collapse of a large proto-galactic nebula: [top-down scenario](#)
- Searle & Zinn (1978): galaxies are built up from merging smaller fragments: [a bottom-up scenario](#)

Problems with the ELS collapse scenario:

- Why are half the halo stars in retrograde orbits? We would expect that most stars would be moving in roughly the same direction (on highly elliptical orbits) because of the initial rotation of the proto-Galactic cloud.
- Why there is an age spread of ~ 3 Gyr among globular clusters (GCs)? We would expect < 1 Gyr spread (free-fall time).

Some important questions that are left without robust answers:

- Why GCs become more metal-poor with the distance from the center?
- Detailed calculations of chemical enrichment predict about 10 times too many metal-poor stars in the solar neighborhood (the G-dwarf problem), why?

Which model for galaxy formation is correct (or less wrong)?

- by observing galaxies at large redshifts (beyond 1), we are probing the epoch of galaxy formation – indeed, **galaxies at large redshifts have very different morphologies**, and the fraction of spirals in clusters is greater than today (Butcher-Oemler effect). Also, **the volume density of galaxies was larger in the past**: appears consistent with the bottom-up approach
- **We have some important detailed evidence for galaxy merging in our own backyard**: the Milky Way structure and kinematics
- **How smooth, or clumpy, is the distribution of stars and their kinematics in the Milky Way?**

The Milky Way Structure, as seen by SDSS

1. Spatial Distribution of Stars
2. Metallicity Distribution
3. Stellar Kinematics

Advantages of SDSS for studying the Milky Way structure

- **Accurate photometry:** distance and [Fe/H] estimates
- **Numerous stars:** small random errors for number density
- **Large area and faint limit:** good volume coverage

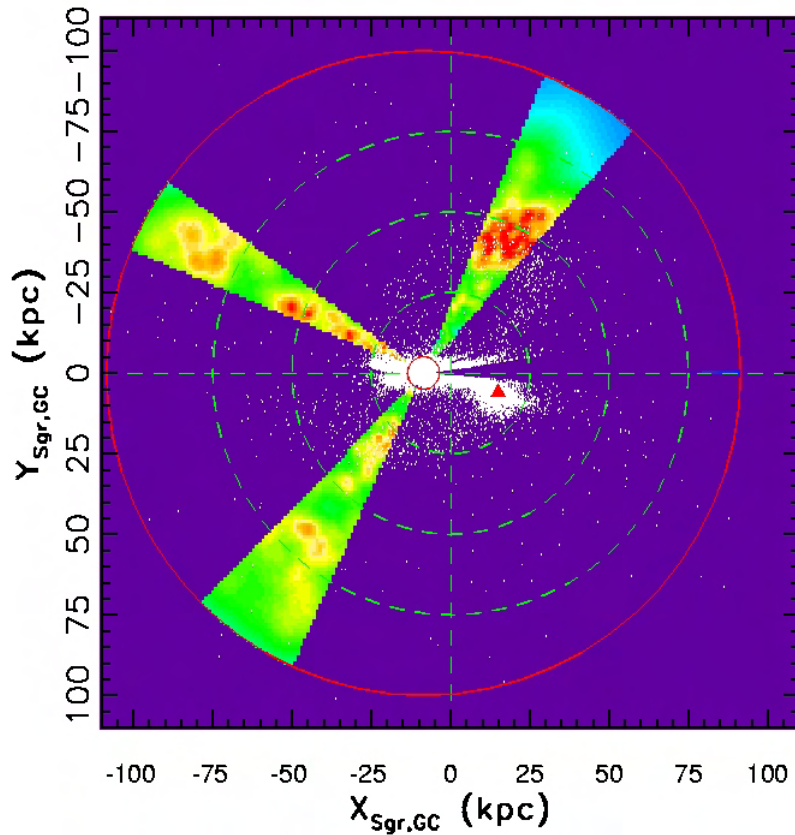

- SDSS RR Lyrae and other luminous tracers, and 2MASS M giants, demonstrate that the Milky Way halo extends to ~ 100 kpc and has a lot of substructure
- SDSS has obtained excellent photometric data for over 100 million stars. How can one utilize these data for studying the disk component?
- What is the structure of the disk component, including kinematics and metallicity distributions?

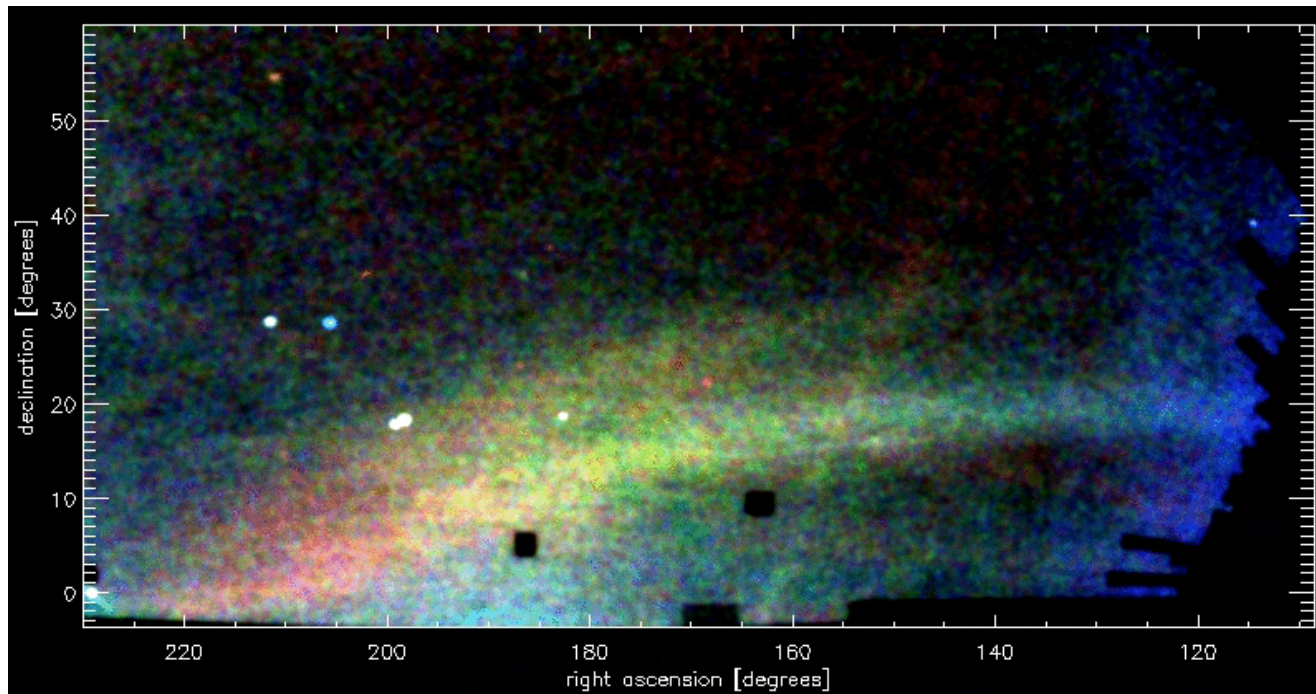

Constraining Thin/Thick Disk+Halo Models

- Observationally, $\rho(z|R = R_{\odot})$ is well fit by a sum of double exponential (thin and thick disk) and power-law profiles.
- However, **the best-fit models are degenerate**: e.g. the thick disk scale height varies by a factor of few and its normalization by an order of magnitude!

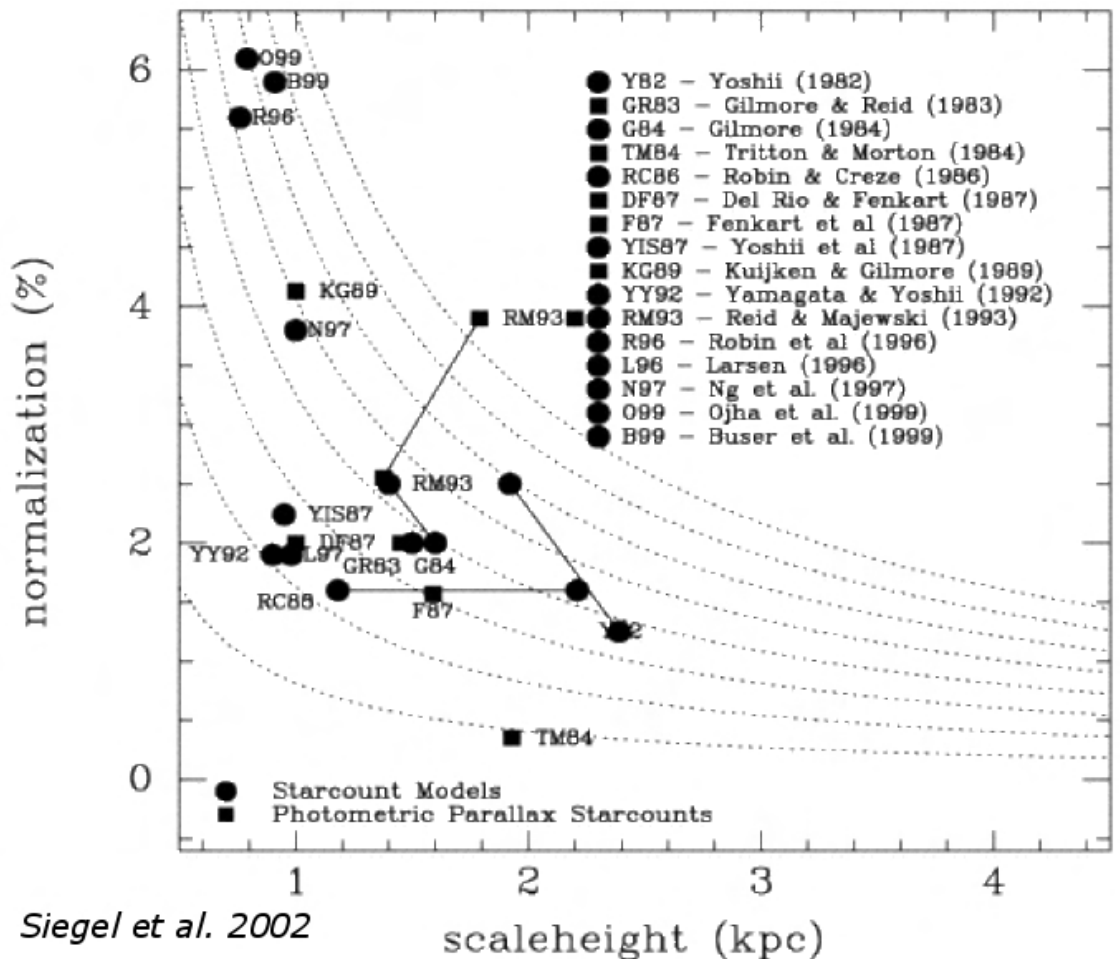
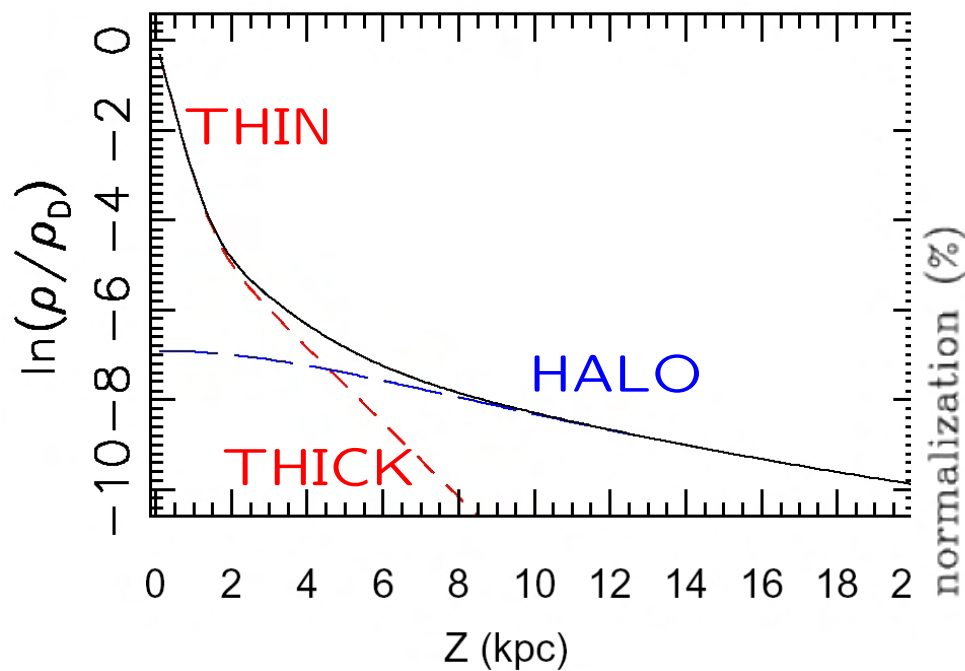

Constraining Thin/Thick Disk+Halo Models

- Observationally, $\rho(z|R = R_\odot)$ is well fit by a sum of double exponential (thin and thick disk) and power-law profiles.
- But, very different models (top: thin and thick disk without halo; middle: single disk and halo, bottom: the difference) can produce the same $\rho(z|R = R_\odot)$
- A large sky area is needed to break model degeneracies (pencil beam surveys are inconclusive)
- SDSS is the first survey with the required data

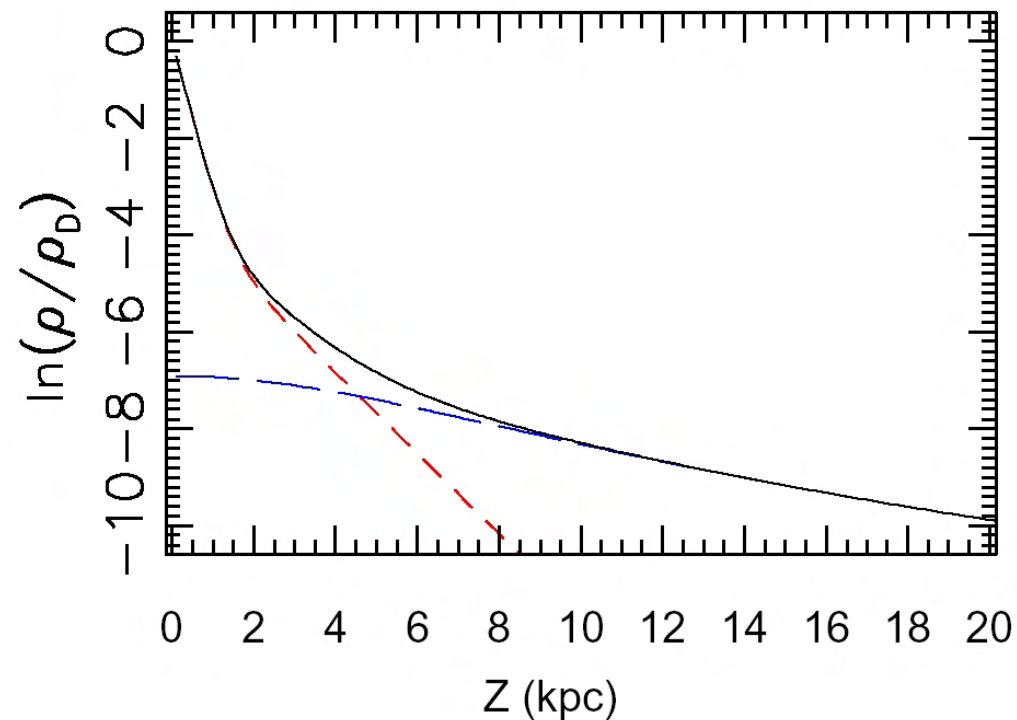
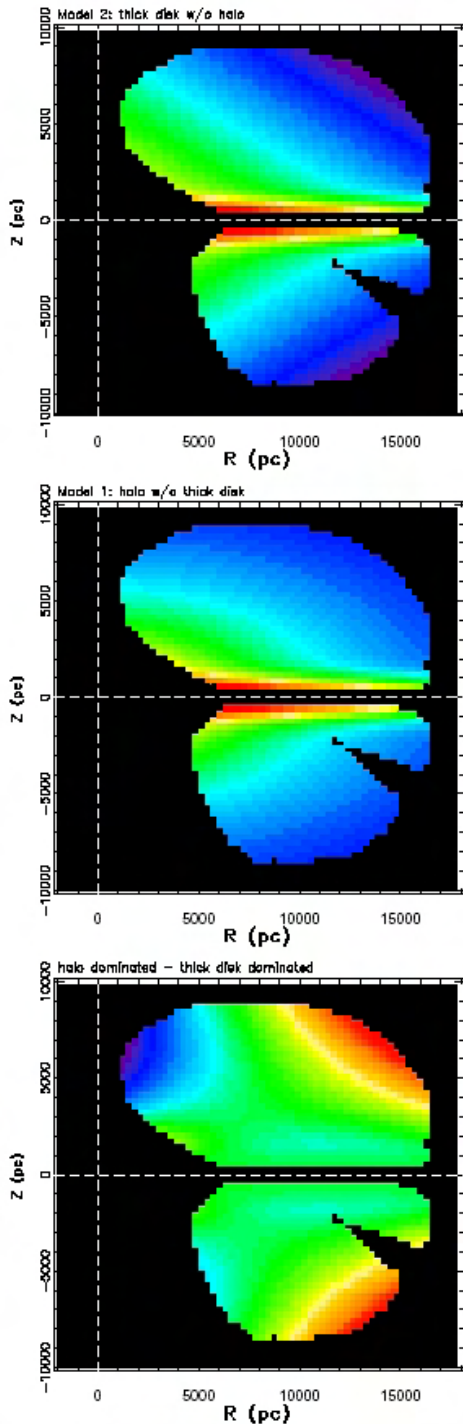

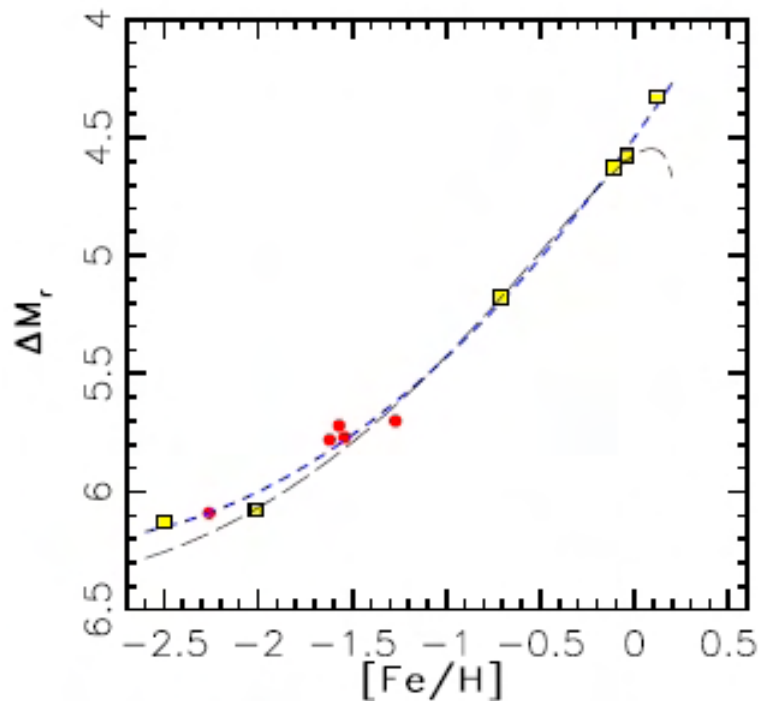
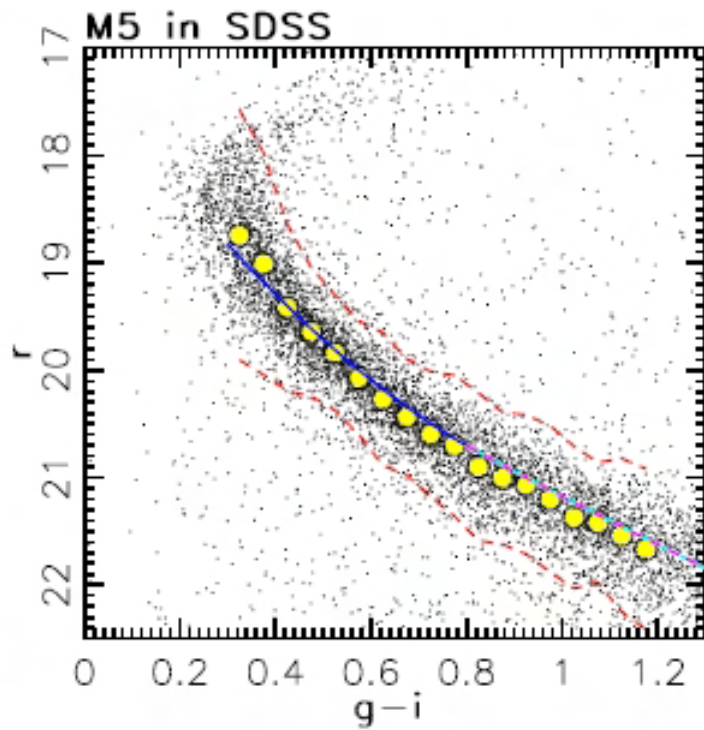

Photometric Distance and Photometric $[Fe/H]$

- Determined absolute magnitude vs. color vs. metallicity relation using globular clusters observed by SDSS (blue end), and nearby stars with trigonometric parallaxes (red end)
- The $g - i$ color of a main-sequence star constrains its absolute magnitude to within 0.1-0.2 mag (0.3 mag for unresolved binaries), assuming $[Fe/H]$ is known

Photometric Distance and Photometric [Fe/H]

- Determined absolute magnitude vs. color vs. metallicity relation using globular clusters observed by SDSS (blue end), and nearby stars with trigonometric parallaxes (red end)
- The $g - i$ color of a main-sequence star constrains its absolute magnitude to within 0.1-0.2 mag (0.3 mag for unresolved binaries), assuming [Fe/H] is known
- For F and G stars ($0.2 < g - r < 0.6$), accurate SDSS $u - g$ color measurements enable photometric metallicity estimates as precise (0.1-0.2 dex) as [Fe/H] derived from SDSS spectra!

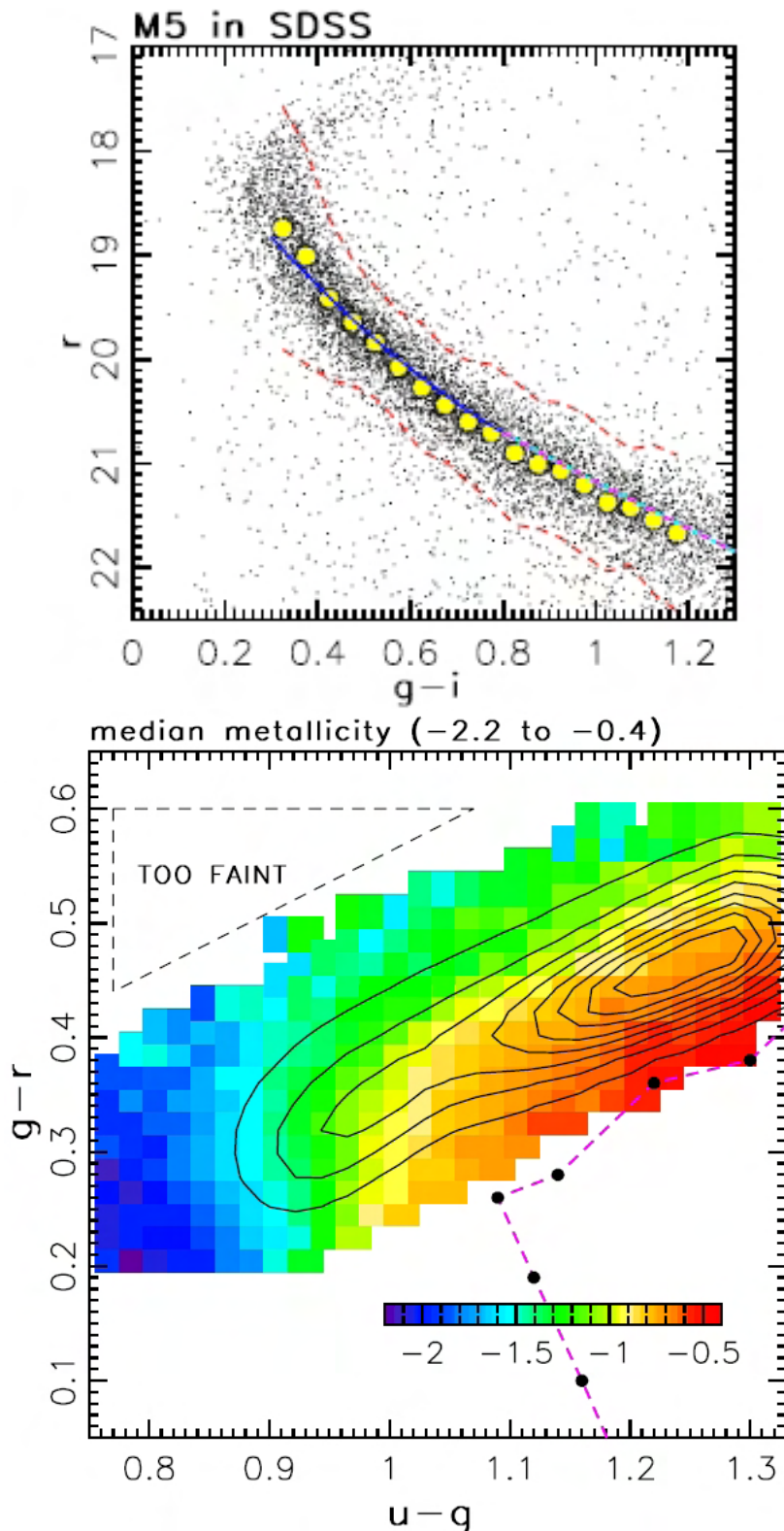

The SDSS Kinematics Data

- **SDSS** has already obtained over 200,000 stellar spectra, with **radial velocities** accurate to ~ 10 km/s
- **SDSS-POSS proper motions** (50 yrs baseline), limited by the POSS astrometric accuracy (0.15 arcsec, after recalibrating POSS astrometry using SDSS positions of galaxies; Munn et al. 2004), resulting in proper motion accuracy of ~ 3 mas/yr, usable to $g \sim 20$: >30 million stars!
- **SDSS-SDSS proper motions** (~ 8 yrs baseline) accurate to ~ 4 mas/yr, usable to $g \sim 21.5$, but only for 300 deg^2

These catalogs enable major progress in kinematic studies of the Galactic structure: 3 mas/yr corresponds to 15 km/s at 1 kpc (and >100 times more accurate than Luyten's catalog)

Dissecting Milky Way with SDSS

Good ugriz photometry gives decent distance (and metallicity) estimates for **PRACTICALLY EVERY SINGLE STAR** within areal and flux (and color) limits, and greatly simplifies the data analysis:

- **Traditional approach:** assume initial mass function, fold with models for stellar evolution; assume mass-luminosity relation; assume some parametrization for the number density distribution; vary (numerous) free parameters until the observed and model counts agree. **Uniqueness? Validity of all assumptions?**
- **SDSS photometric parallax approach:** adopt color-luminosity relation, estimate distance to each star, bin the stars in XYZ space and directly compute the stellar number density (for each narrow color bin). **There is no need to a priori assume, the number of, and analytic form for Galactic components**

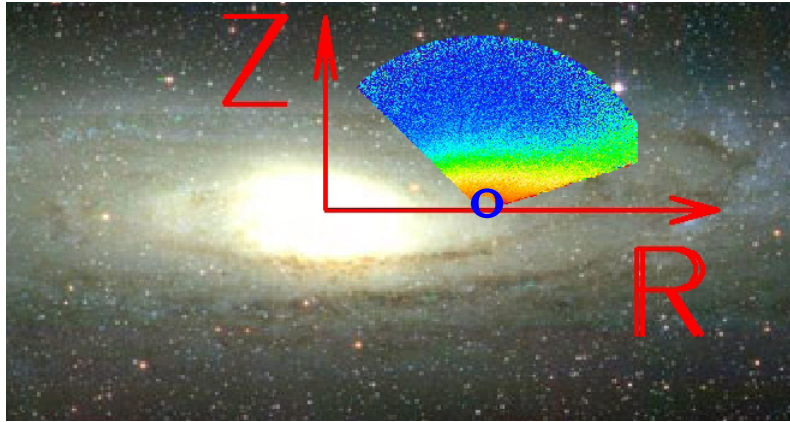

Local maps: thin disk

- Red(ish) stars have small luminosity: sampled to a few kpc
- Out to ~ 1 kpc, the maps are roughly consistent with an exponential disk: the lines of constant density are straight lines
- The slope of these lines is given by the ratio of exponential scale height and scale length

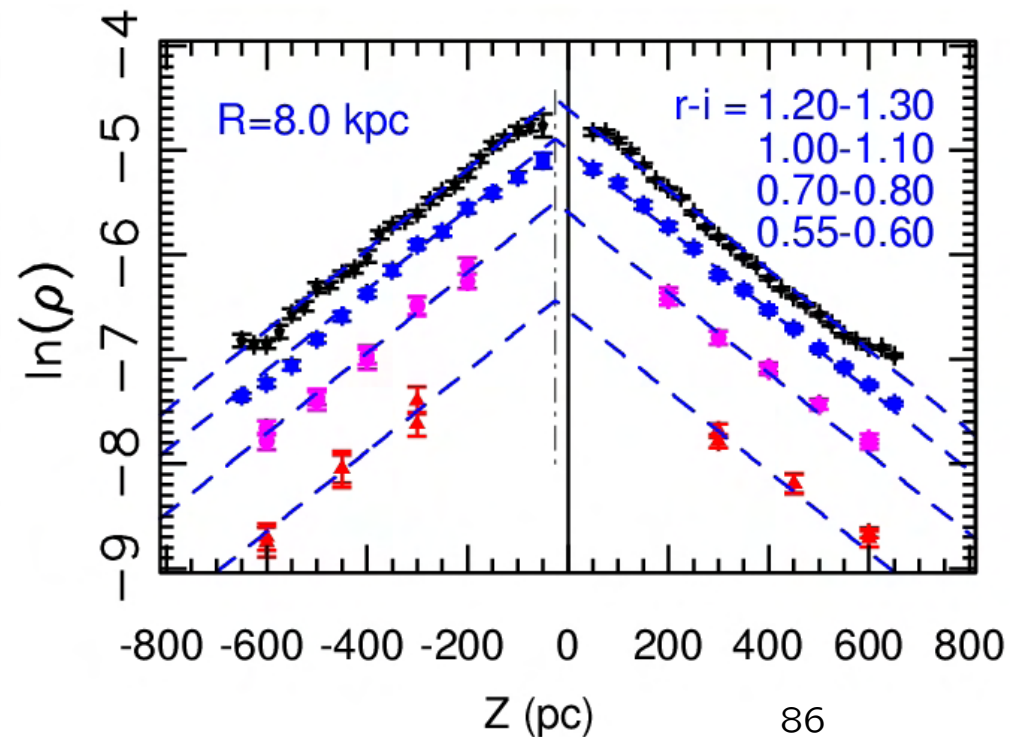
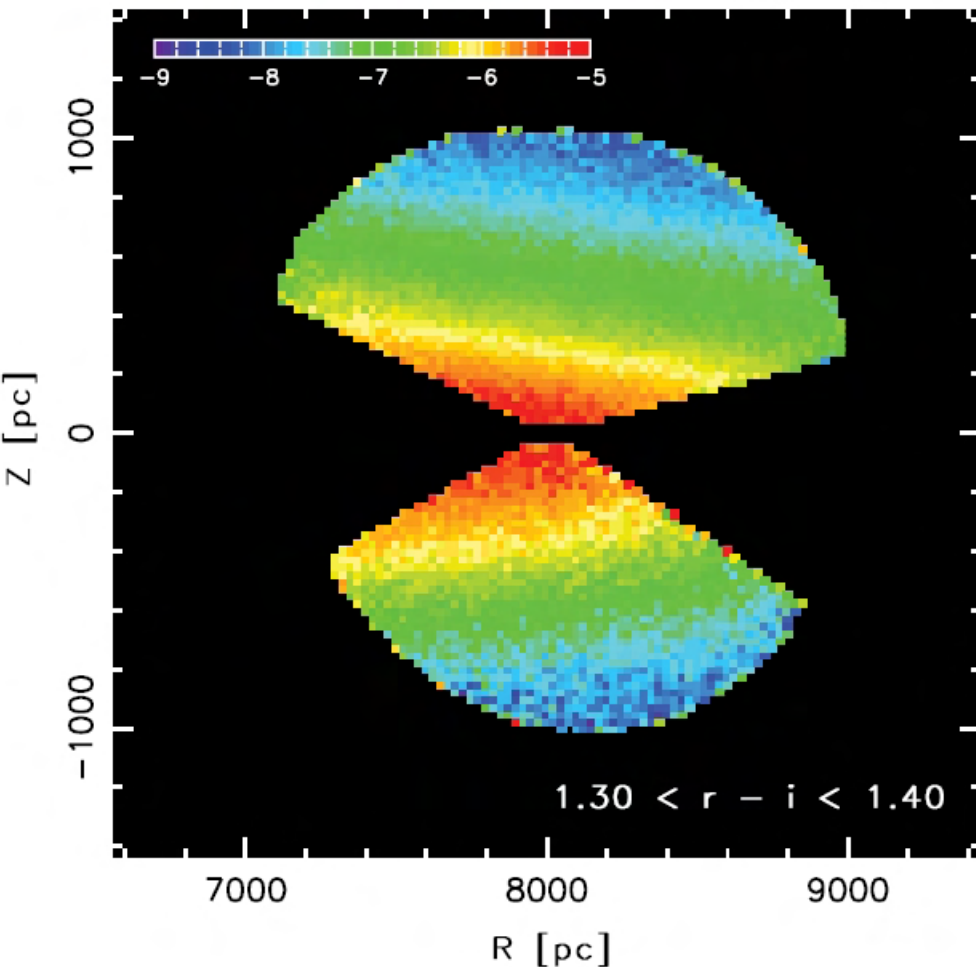

The r-i color bins sample a variety of scales

19 r-i color bins - 19 density maps



r-i	0.1	0.2	0.4	0.6	0.8	1	1.2	1.4
D [kpc]	15	13	7	4	3	2	1.5	1
SpT	~F9	G6	K4	K7	M0	M1	M2	M3

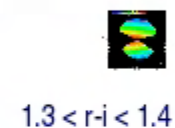
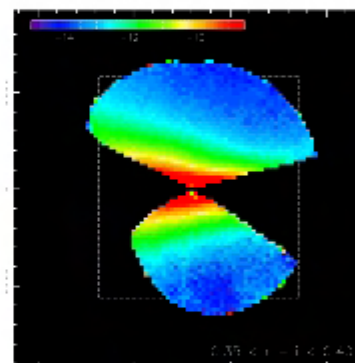
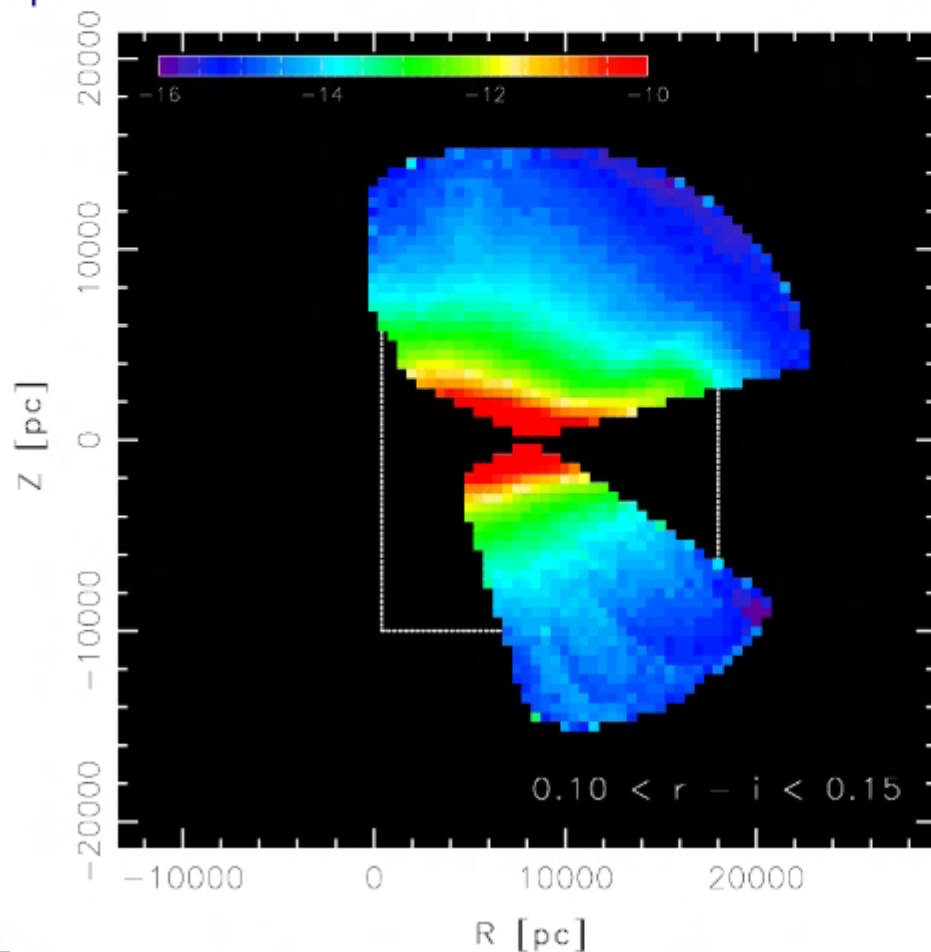

$0.35 < r-i < 0.40$

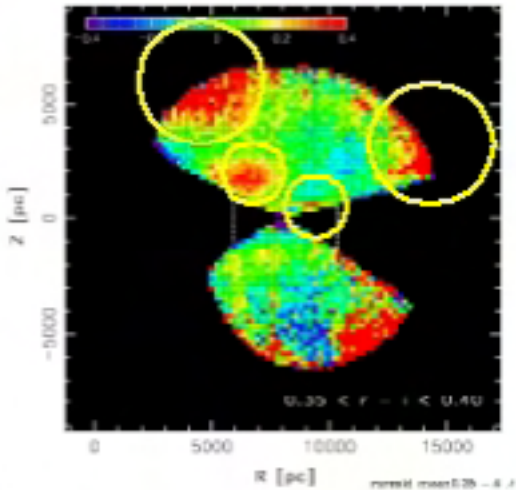
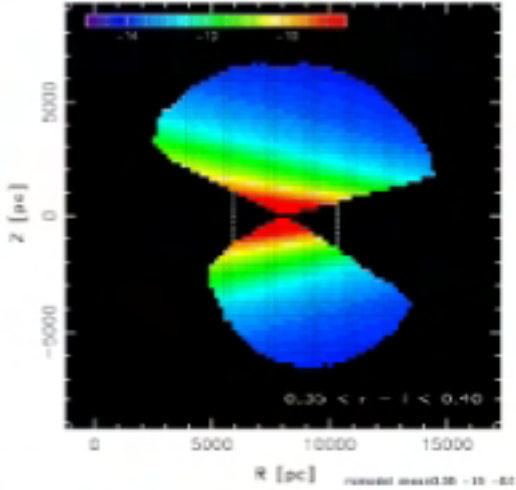
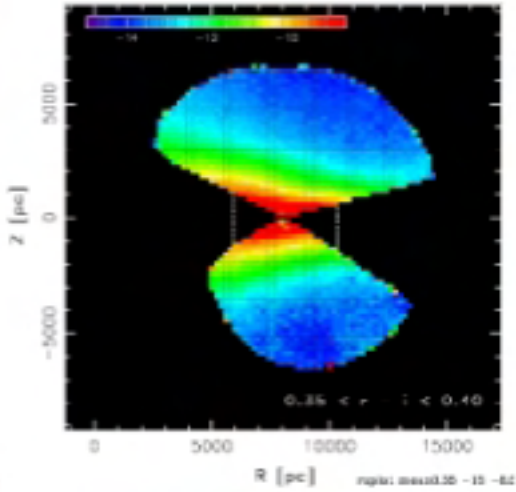

Dissecting the Milky Way with SDSS

- Jurić et al. 2008 (ApJ 673, 864): panoramic view of the Milky Way, akin to observations of external galaxies; with exceedingly high signal-to-noise!

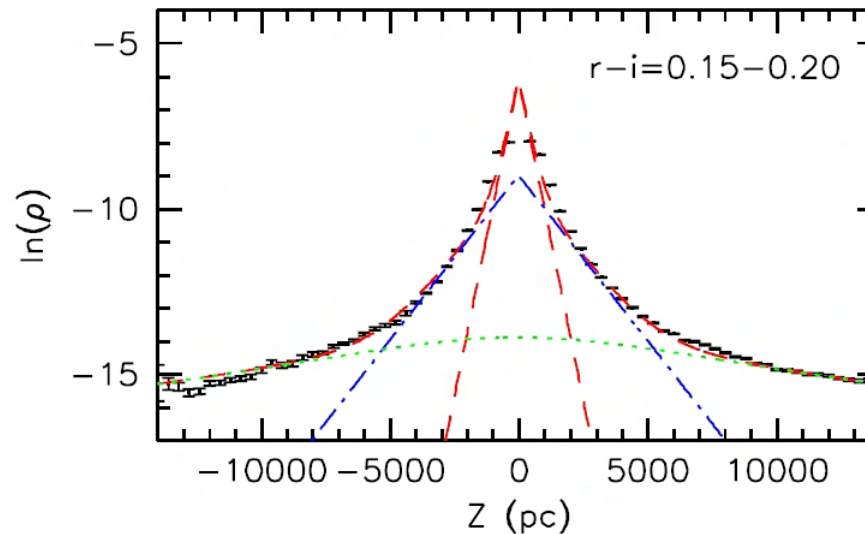
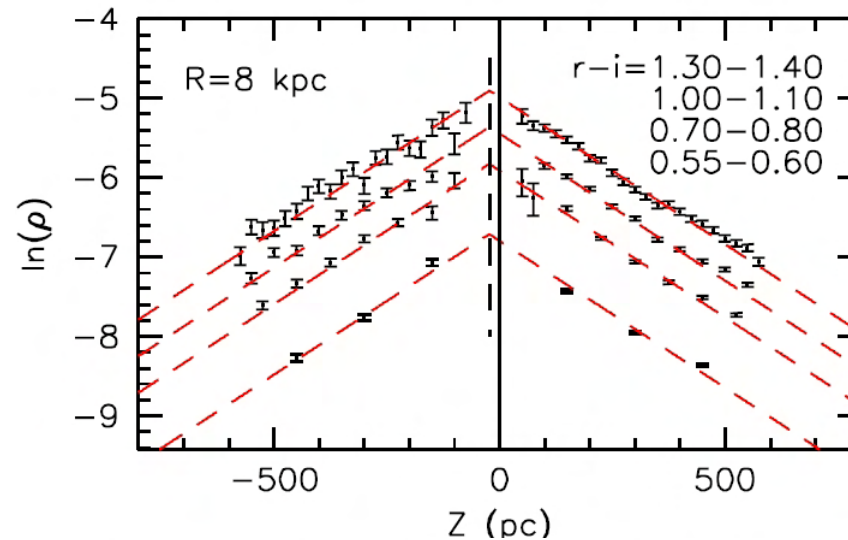

$0.35 < r_i < 0.40$

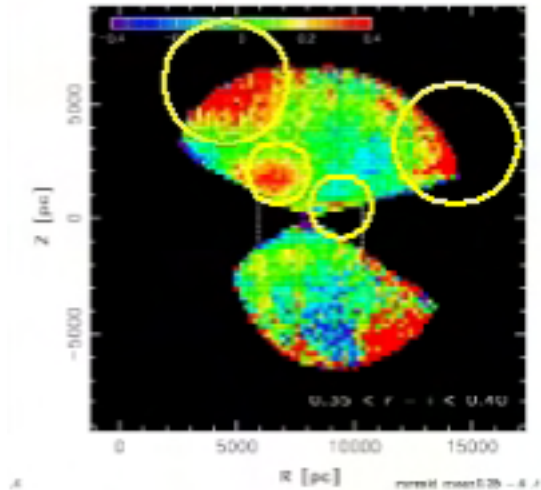
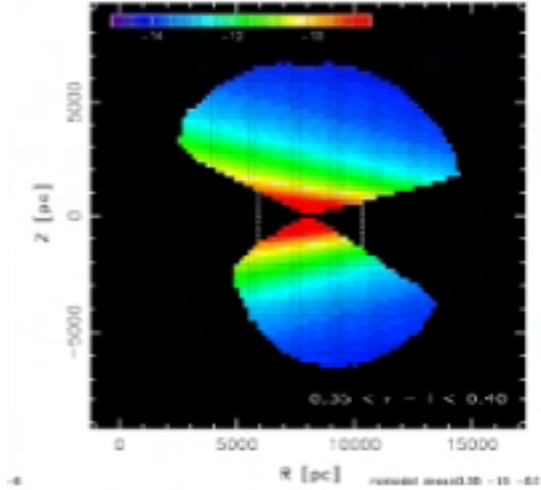
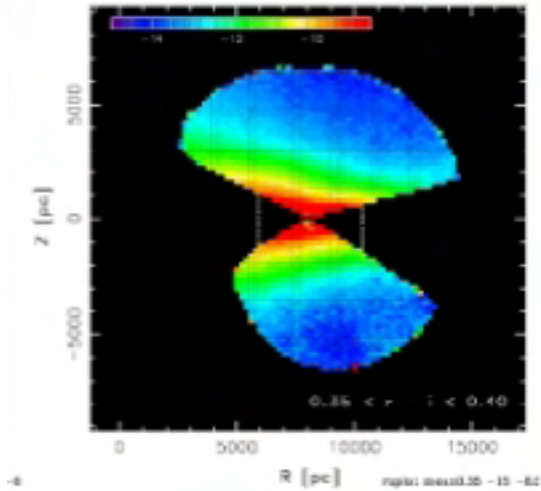

Dissecting the Milky Way with SDSS

- Panoramic view of the Milky Way: good support for standard Galactic models
- Are we overfitting data with two disks and a halo?
- Metallicity mapping supports components inferred from number counts mapping:

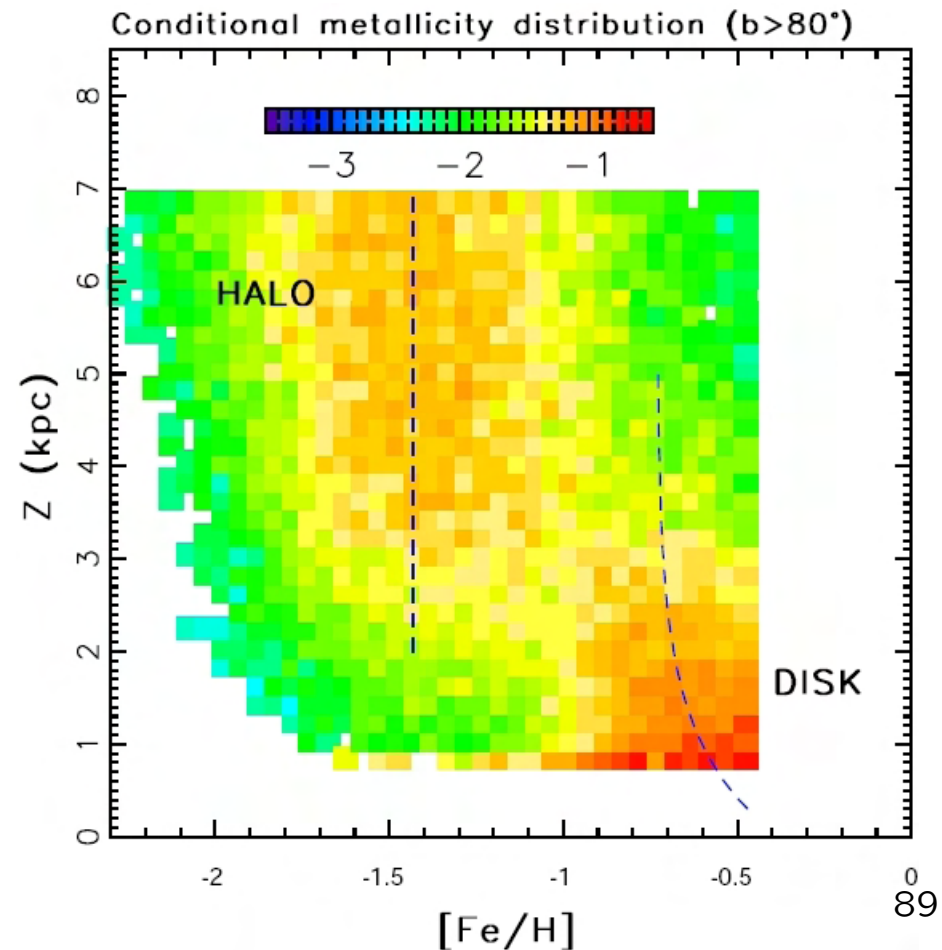

0.35 < r-i < 0.40

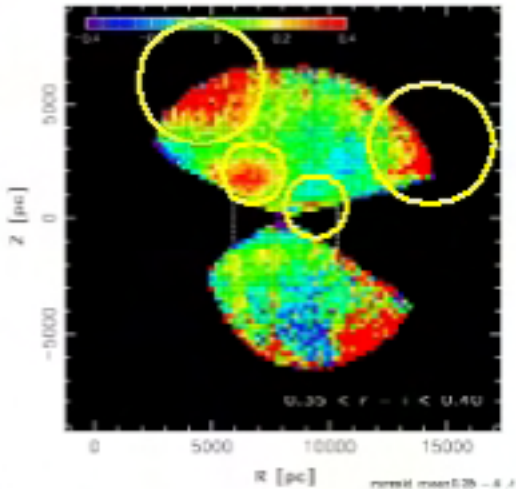
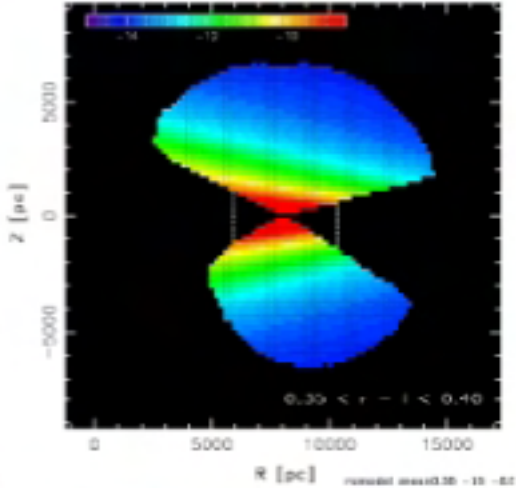
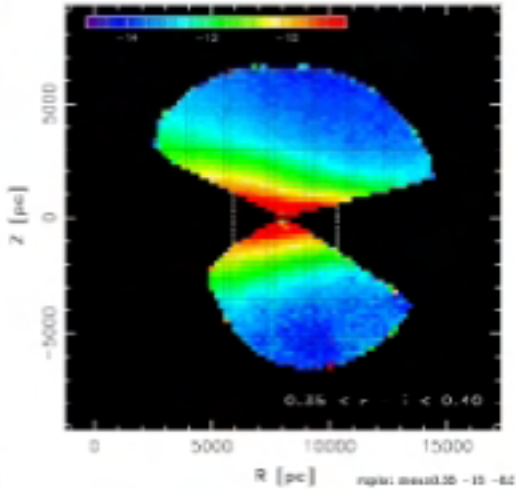

Dissecting the Milky Way with SDSS

- Panoramic view of the Milky Way: good support for standard Galactic models:

- Removal of obvious clumps
- Fit to least “contaminated” bins
- Exponential disks + halo models

$$\rho(R, Z) = \rho_{thin} e^{-\frac{R-R_e}{l_{thin}} - \frac{|Z+Z_0|}{h_{thin}}} + \rho_{thick} e^{-\frac{R-R_e}{l_{thick}} - \frac{|Z+Z_0|}{h_{thick}}} + \rho_{halo} \left(\frac{R_{GC}}{\sqrt{R^2 + (z+z_0)^2 / q^2}} \right)^n$$

SDSS

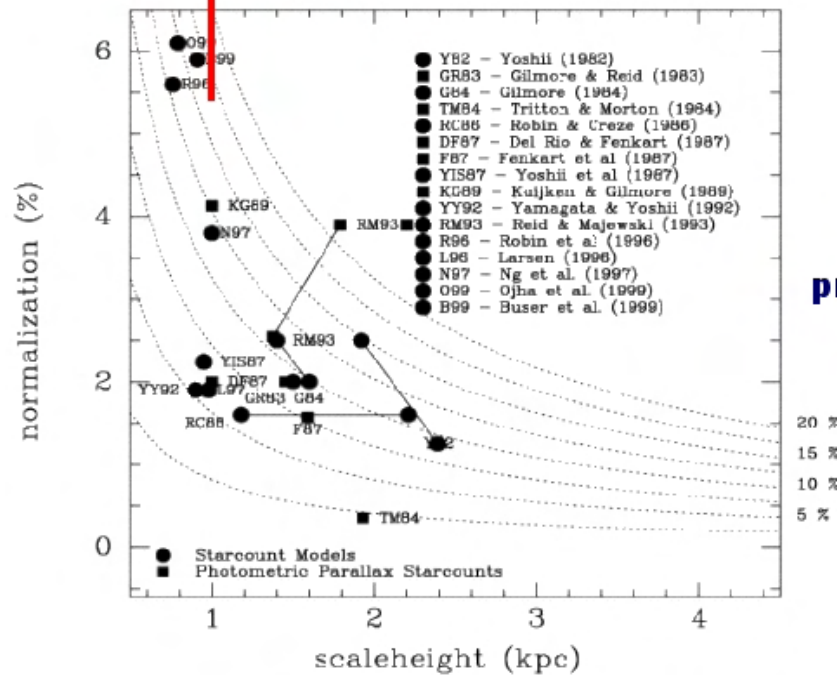

Comparison with prior measurements:
SDSS is off scale!

$0.35 < r-i < 0.40$

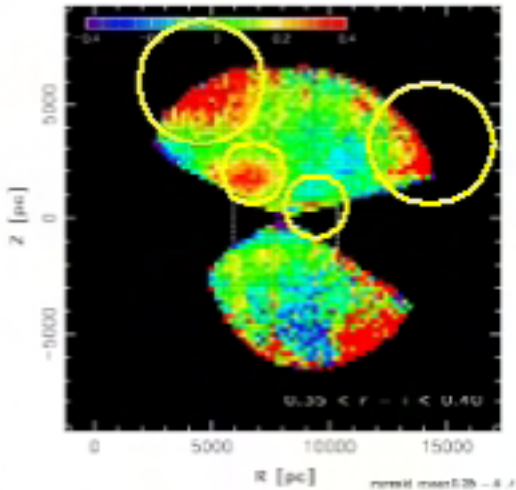
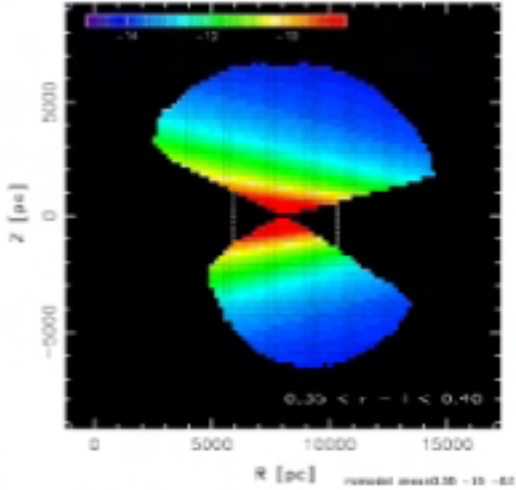
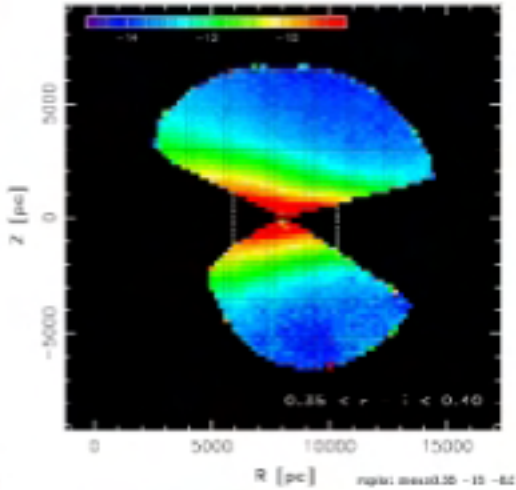

Dissecting the Milky Way with SDSS

- SDSS count maps provide good support for standard Galactic models
- However, the subtraction of (conventional) best-fit model maps from the data maps reveals **rich substructure**
- The number count excess is typically 20-40% – not easy to see with older data!

The Virgo overdensity

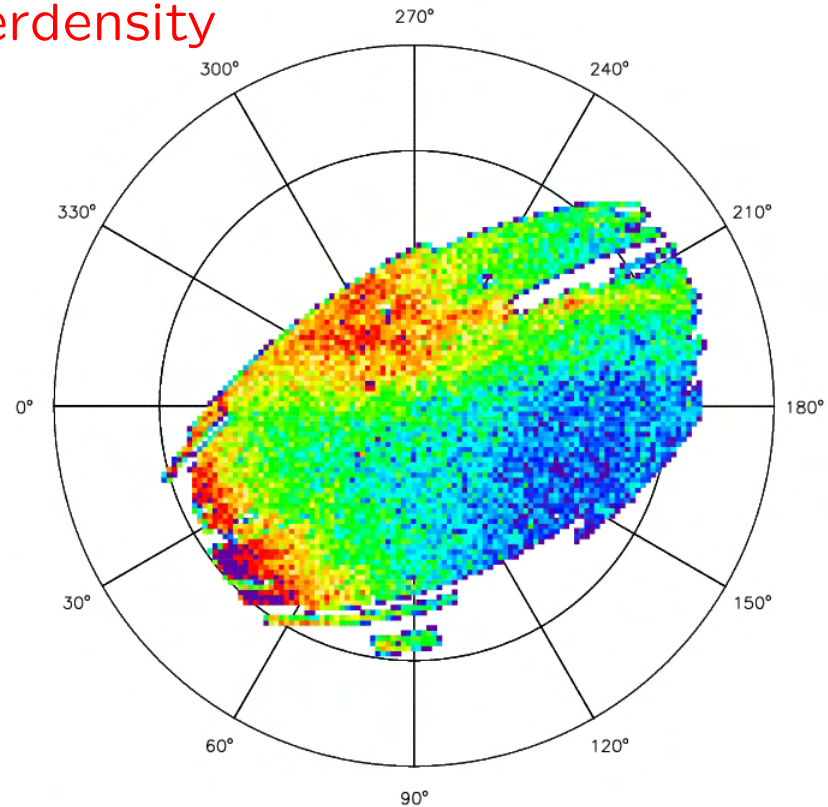

Summary of Stellar Count Analysis

More details in Jurić et al. 2008 (ApJ 673, 864)

- 3D stellar number density maps of the Milky Way from SDSS observations of ~ 50 million stars; analysis based on photometric distances and thus model-independent
- A two-component exponential disk model is in fair agreement with the data; halo properties, such as power-law index, poorly constrained due to rich substructure and limited sky coverage; however, an oblate halo is always preferred (no strong evidence for triaxial halo)
- A remarkable localized overdensity in the direction of Virgo over ~ 1000 deg² of the sky
- **Clumps/overdensities/streams are an integral part of Milky Way structure, both of halo and the disk(s)**

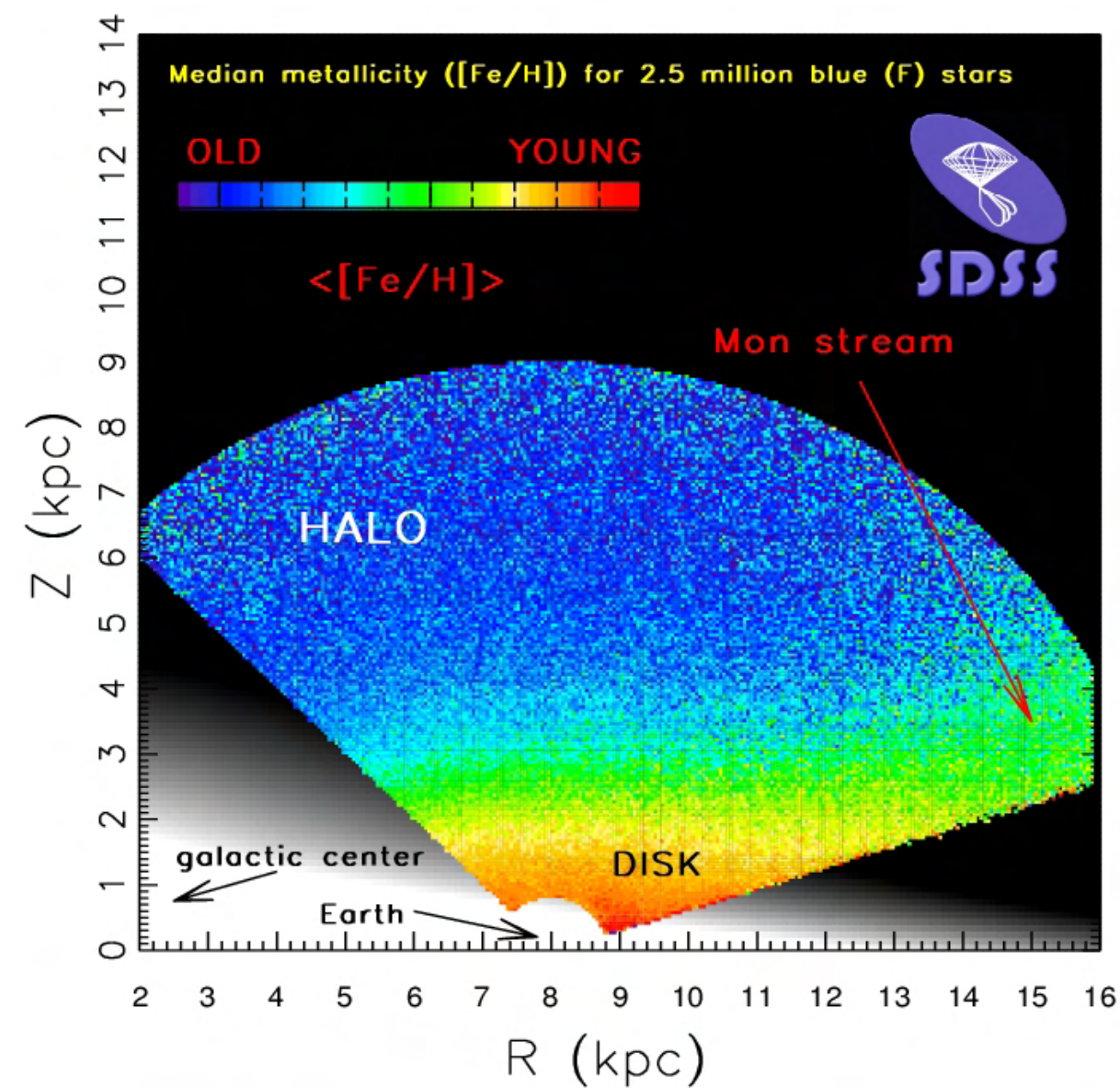

A much harder analysis problem than counts; instead of a single count value, at each position: $p([Fe/H])$ and $p(v_\phi, v_R, v_Z)$!

Metallicity and Kinematics

- Panoramic view of the Milky Way metallicity distribution: the median metallicity map contains $\sim 8,000$ pixels (0.1 kpc by 0.1 kpc), and is based on a complete flux- and color-limited sample of ~ 2.5 million blue stars.
- The median metallicity is a strong function of distance from the Galactic plane; deviations are associated with spatial (and kinematic) substructures

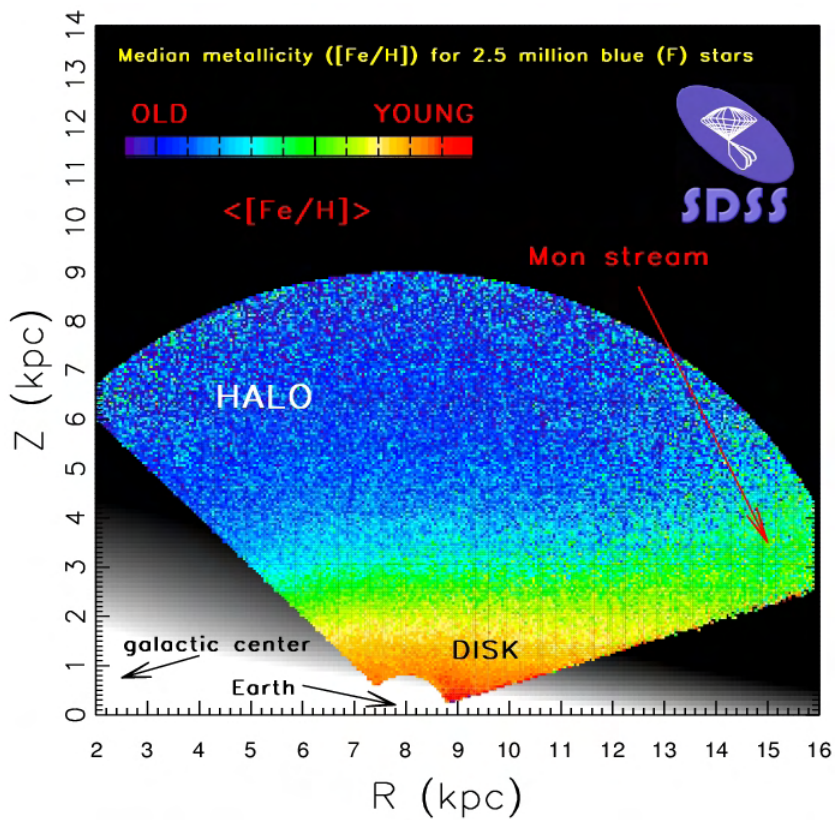

Metallicity and Kinematics

- **Metallicity mapping** supports components inferred from number counts mapping: remarkable disk–halo separation!
- **Kinematics** correlated with metallicity: high-metallicity (disk) stars rotate, low-metallicity (halo) stars on random highly eccentric orbits

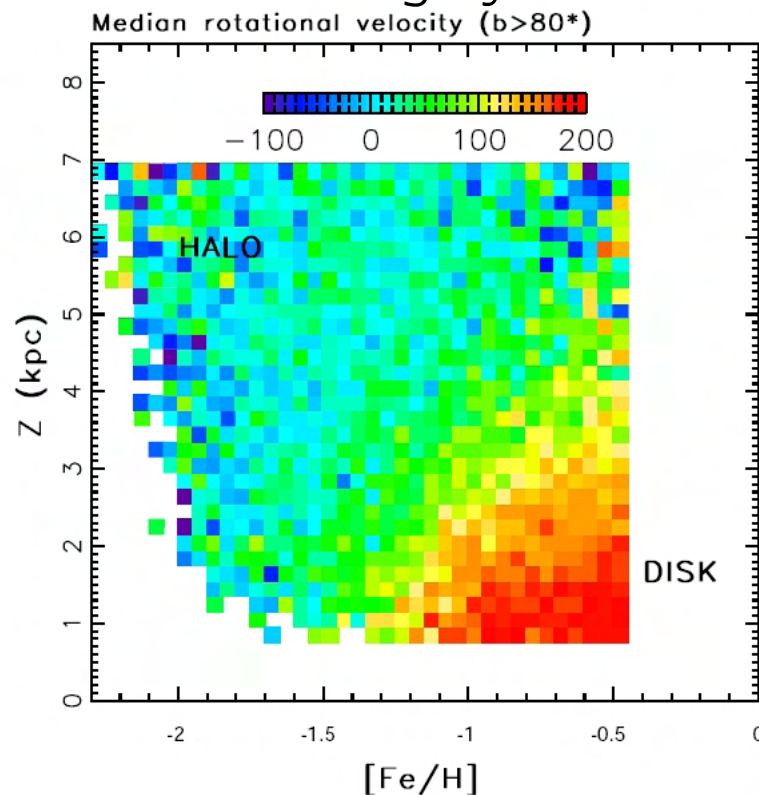
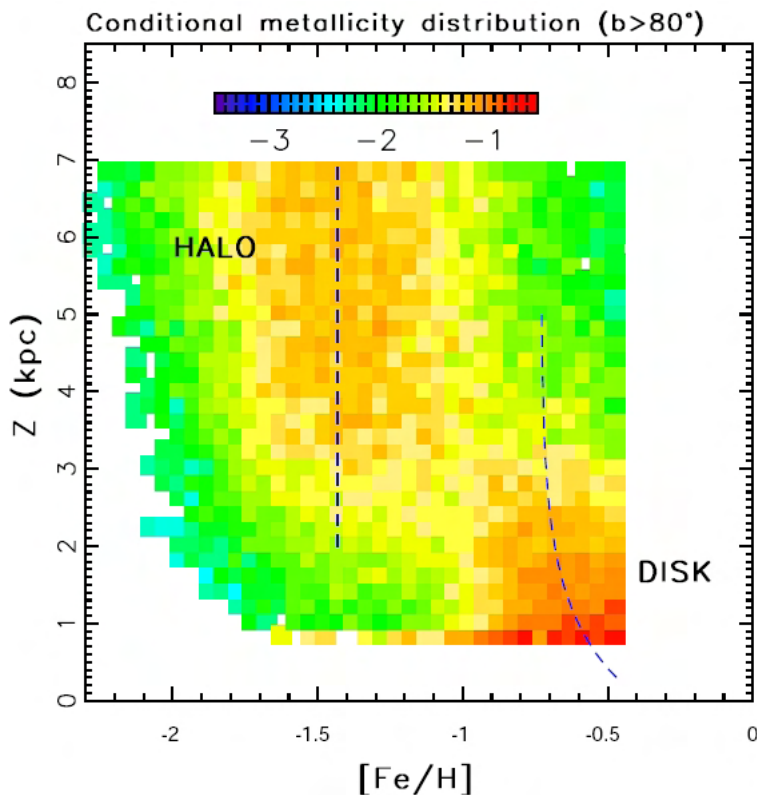

Disk vs. Halo Kinematics

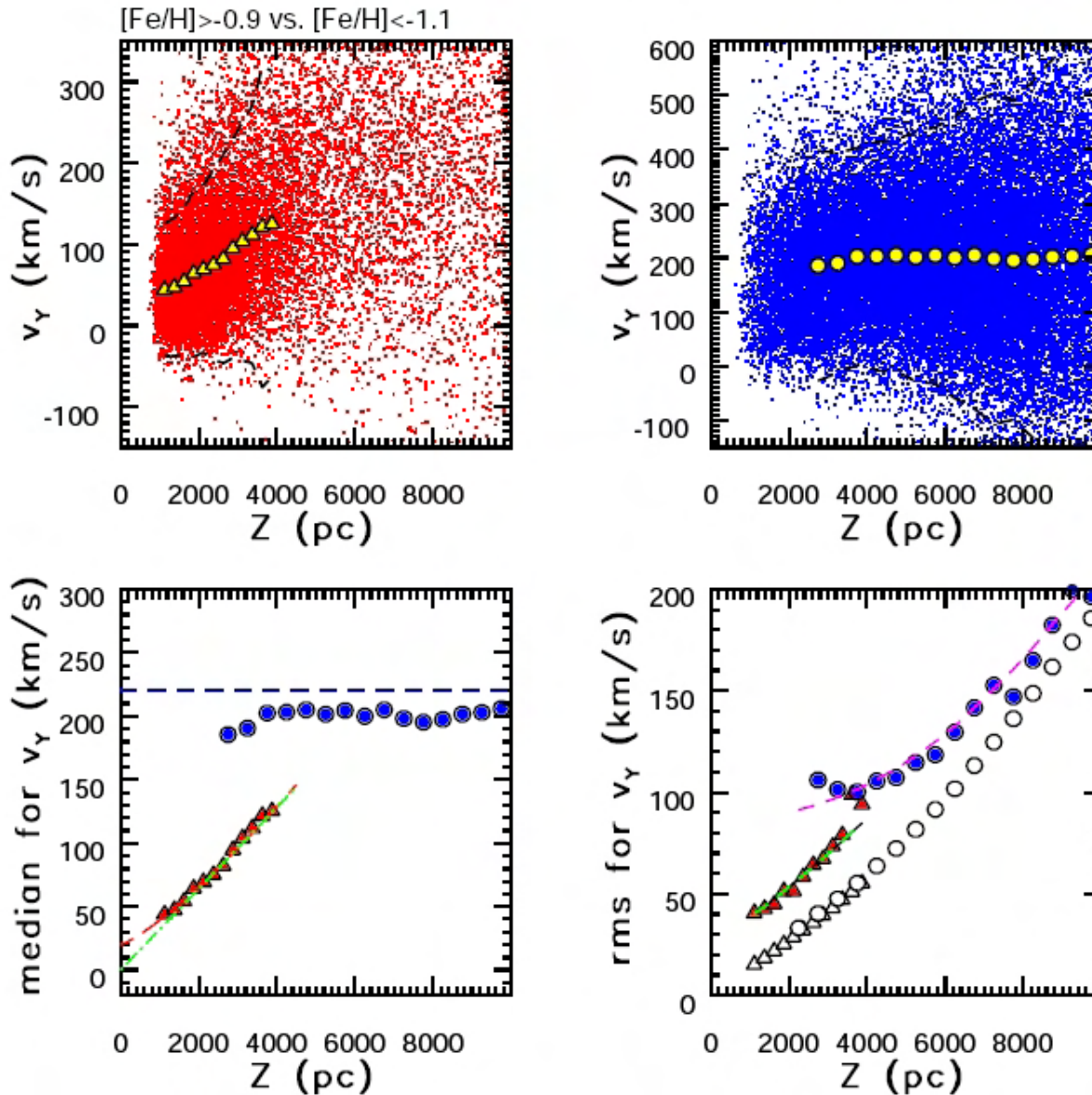

- **Top panels:** small dots are individual stars, large symbols are the median values.

- **Top left:** disk stars show clear velocity shear (increase of v_ϕ with Z)

- **Top right:** halo stars $< v_\phi > \sim 220$ km/s

- **Bottom left:** velocity shear is **not** linear

- **Bottom right:** velocity dispersion slowly increases with Z for disk stars, while for halo stars it is spatially invariant

Is velocity shear simply a consequence of thick disk becoming dominant over thin disk beyond 1-2 kpc?

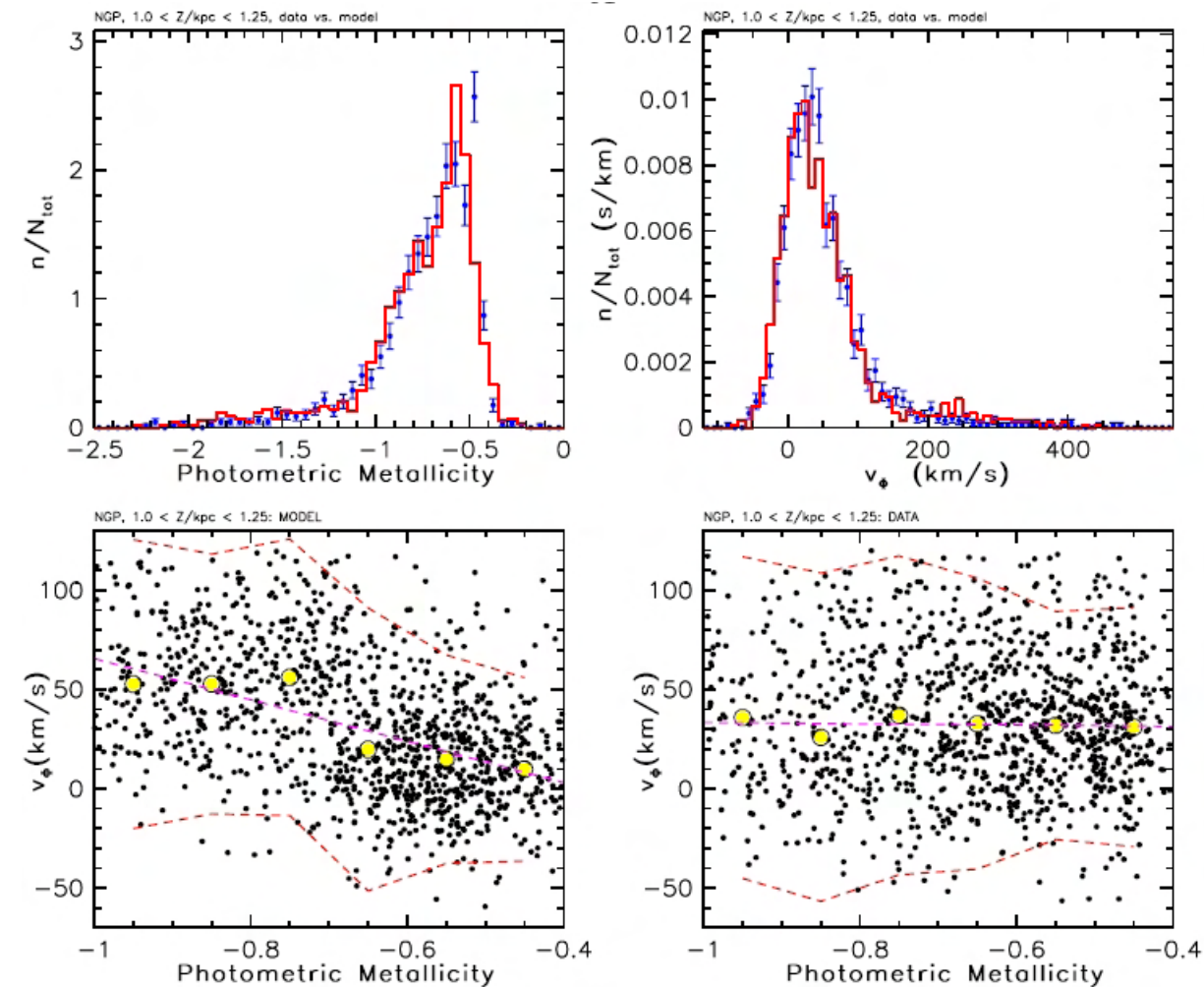

- The **measured** metallicity and rotational velocity are **not** correlated (bottom right): **Kendall's $\tau = 0.03 \pm 0.03!$**
- The **modeled** metallicity and rotational velocity **are** correlated (bottom left): **$\tau = -0.30 \pm 0.03$**

Difficulties with Thin/Thick Disk Decomposition

- Both rotational velocity distribution and metallicity distribution for disk stars vary with Z (in the range 0.5 to 5 kpc). Traditionally, these variations are interpreted as due to varying count normalization ratio of thin and thick disk components
- Traditional thin/thick disk decomposition (two components offset by 0.2 dex and 50 km/s) predicts a correlation between metallicity and rotational velocity: **not observed!**

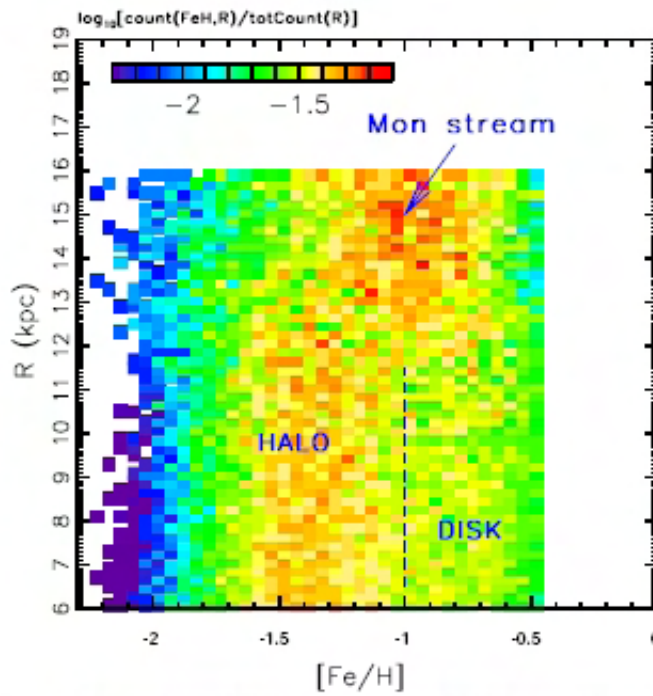
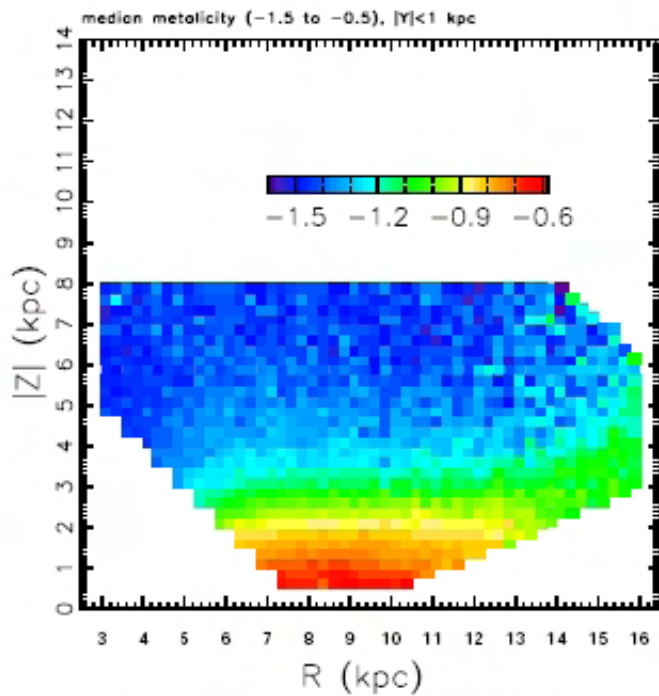

More Substructure

- Monoceros stream was discovered using stellar counts
- It is also identified as a substructure in metallicity space... LEFT
- And kinematics, too: it rotates faster than LSR by ~ 50 km/s
- More details: Ivezić et al. 2008 (ApJ 684, 287)

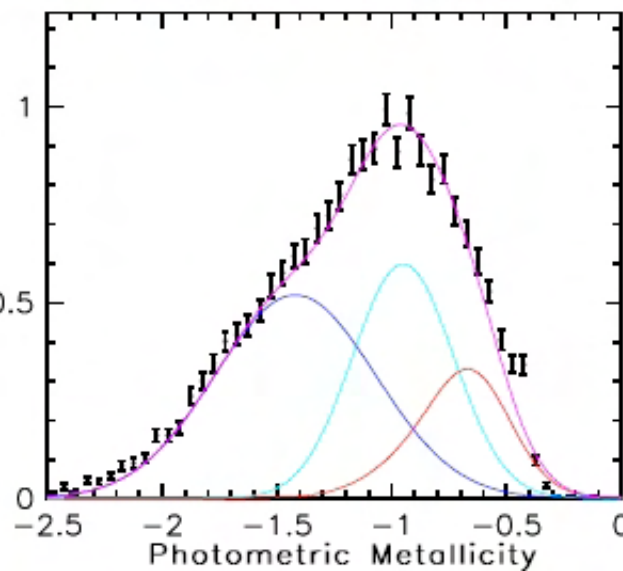
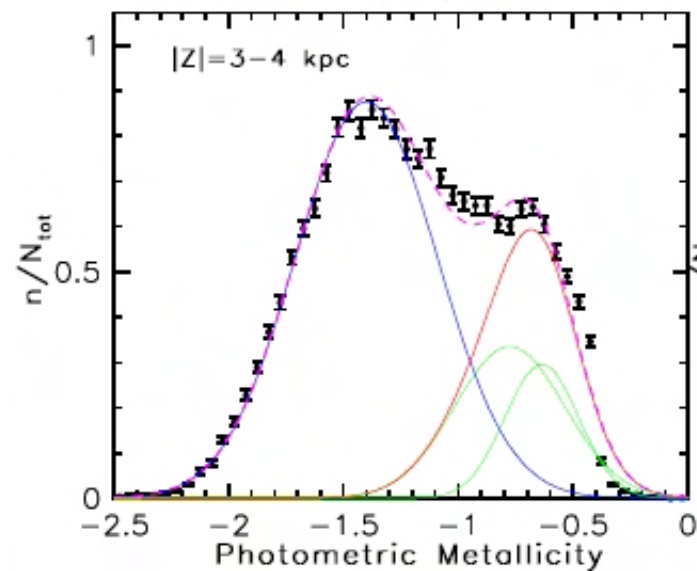

Substructure can also be identified using metallicity and kinematics maps!

Grand Summary of Results on the Milky Way Structure

- Clumps/overdensities/streams are an integral part of Milky Way structure, both for halo and disk components; a similar complexity is seen in the kinematics and metallicity distributions
- The rotational lag, velocity dispersion and metallicity distribution for disk stars are **smooth** functions of Z
- The absence of correlation between rotational velocity and metallicity for disk stars is in **conflict with traditional thin/thick disk decomposition**

SDSS is revolutionizing studies of the Galactic structure

LSST will do even better! (lecture IV...)

Lecture III

1. Galaxies

- Colors, Spectra, Morphology

2. AGNs and Quasars

- Color selection, variability

3. Cosmology

- Large-scale structure, baryon acoustic oscillations

Hubble's Classification of Galaxies

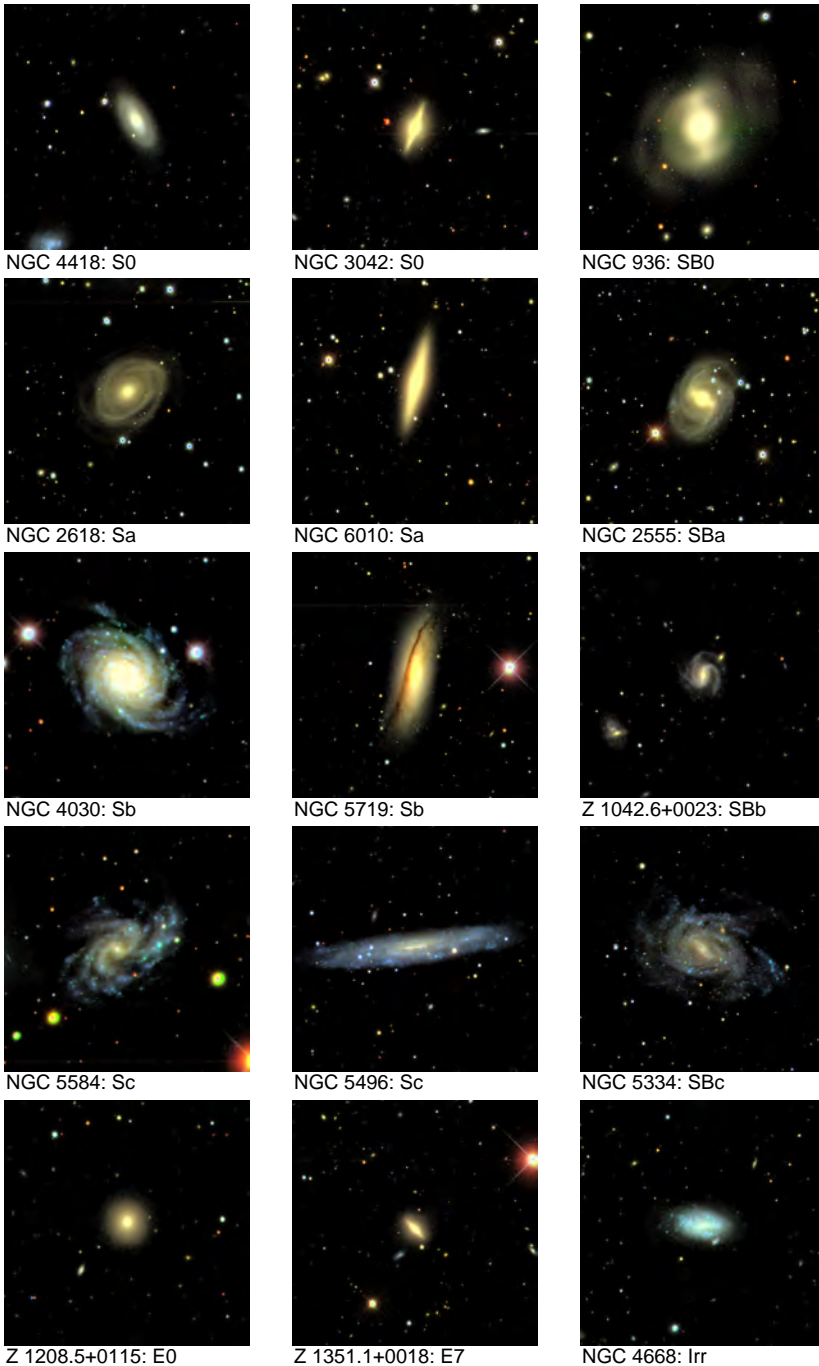

5 arcmin x 5 arcmin true-color g-r-i images from SDSS commissioning data. Galaxy classification is from SIMBAD.

Zeljko Ivezic and Robert Lupton for the SDSS Collaboration.

Galaxies in SDSS

- Galaxies are (mostly) made of stars (also gas, dust, AGN); hence have similar (but not identical) color distributions

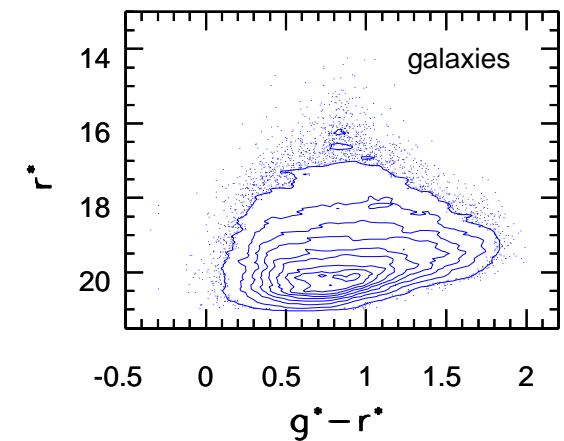
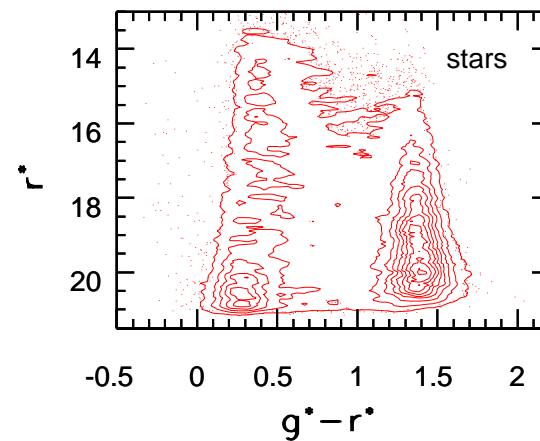
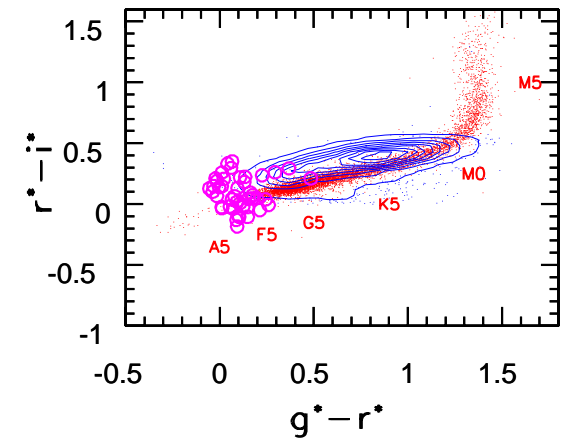
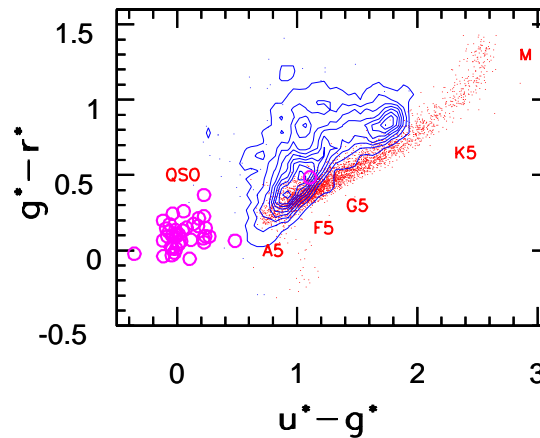

SDSS Spectroscopic Galaxy Survey

- Two samples: the “main” galaxy sample ($r_{Pet} < 17.77$, Strauss et al. 2002), and luminous red galaxy sample (LRG, cut in color-magnitude space, Eisenstein et al. 2002)
- Distance estimate allows the determination of luminosity function (Blanton et al. 2001)
- Spectra are correlated with morphology (and colors)

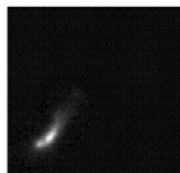
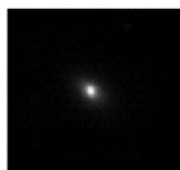
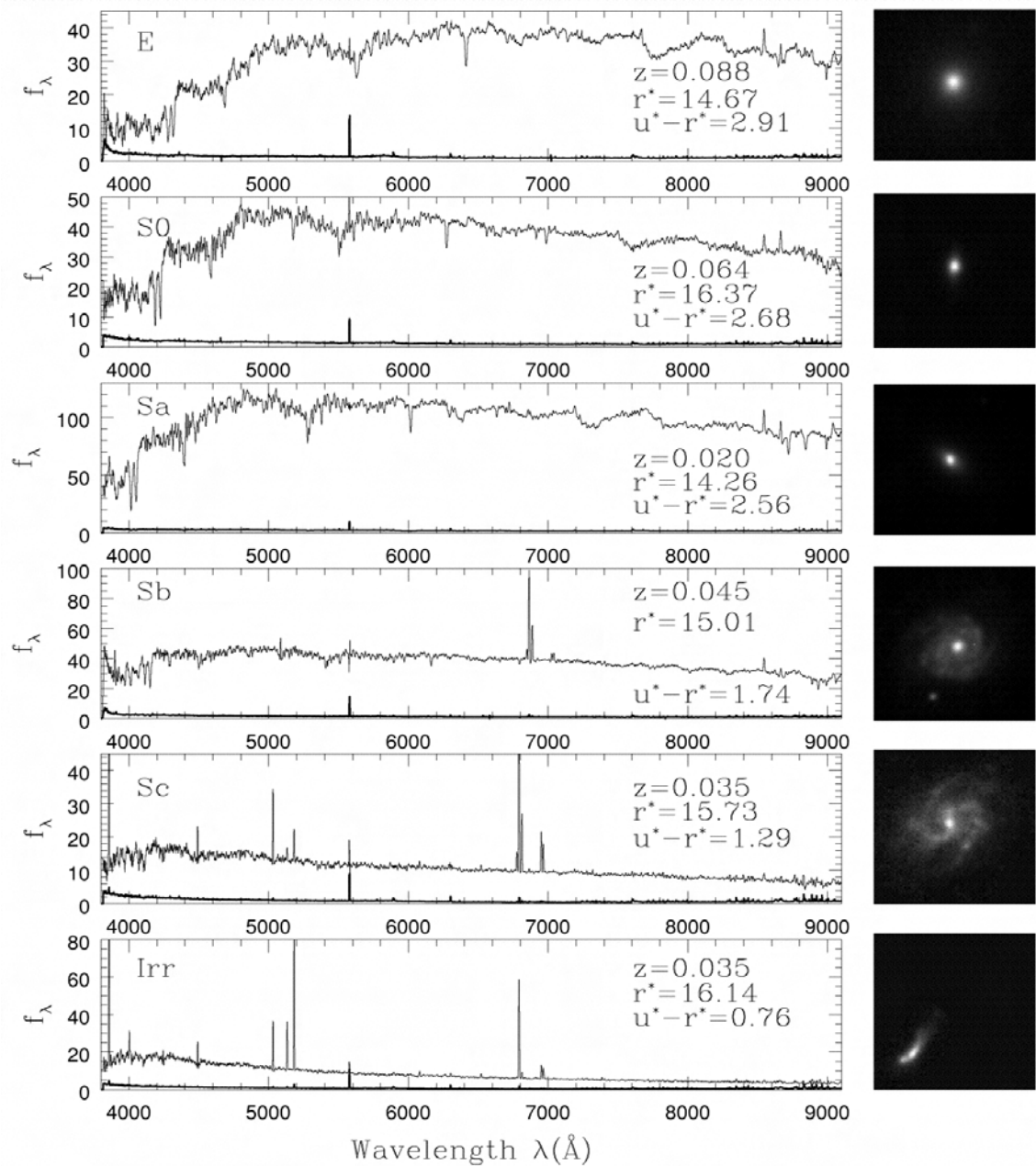

- Spectra are correlated with morphology
- Principal component analysis: spectra form a low-dimensional family: it is possible to describe most of variance using only 2 parameters (Yip et al. 2004)
- Colors synthesized from spectra: a nearly one-dimensional family (to within ~ 0.03 mag, Smolčić et al. 2006)
- “Everything is correlated with everything” (Blanton et al. 2003)

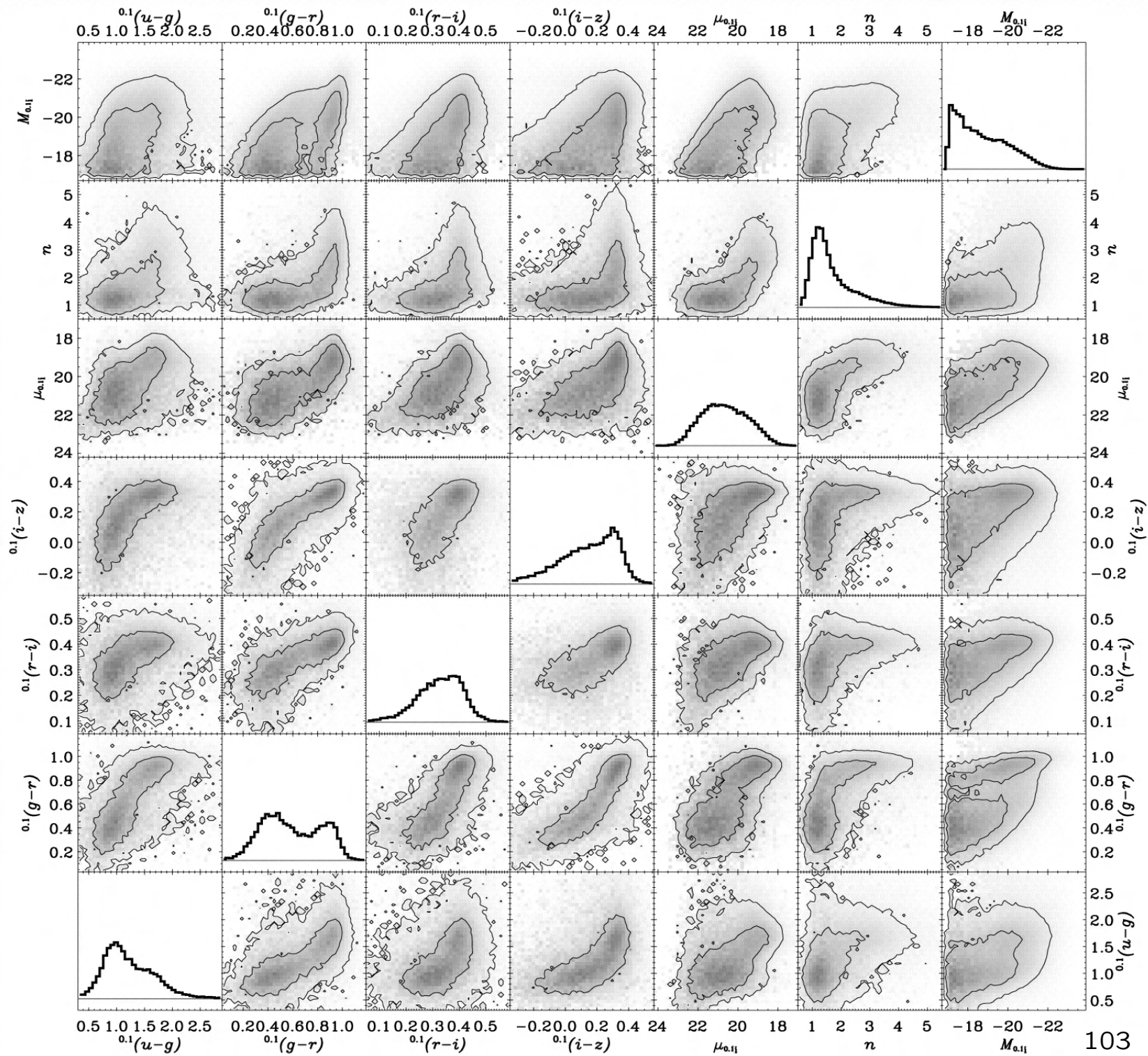

Spectral analysis

- Kauffmann et al. (2003, 2004): model-dependent estimates of stellar mass and dust content using H_δ , D_{4000} and broad-band colors.
- From the position in the $H_\delta - D_{4000}$ diagram, get a model-dependent estimate of stellar mass-to-light ratio, and using measured luminosity get stellar mass. The measured luminosity is corrected for the dust extinction estimated from the discrepancy between the model-predicted and measured broad-band colors.

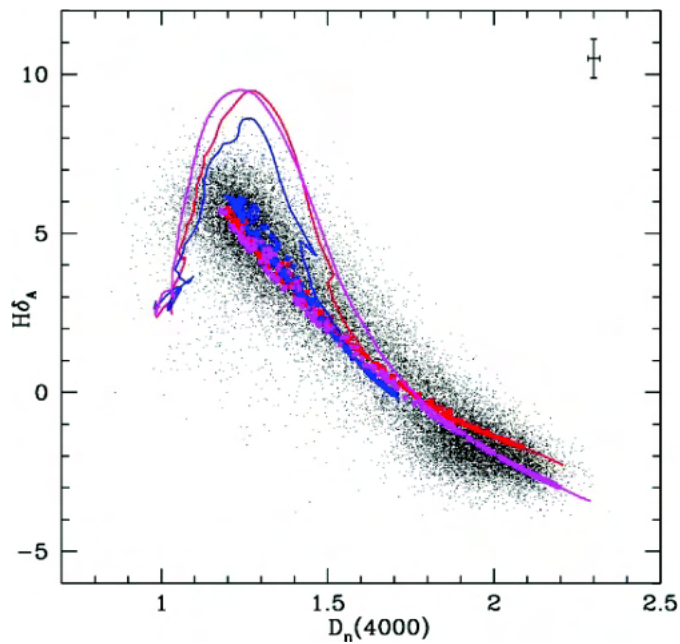
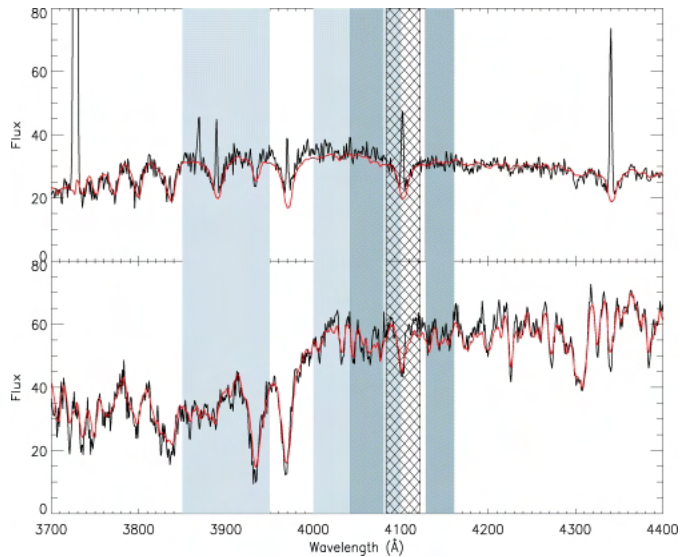

Spectral analysis

- The Baldwin-Phillips-Terlevich diagram: for separating AGNs from star-forming galaxies (Kauffmann et al; Lao et al. 2004)
- Quasars are very luminous ($M_B < -23$): in ground-based seeing appear as point sources beyond $z \sim 0.5$

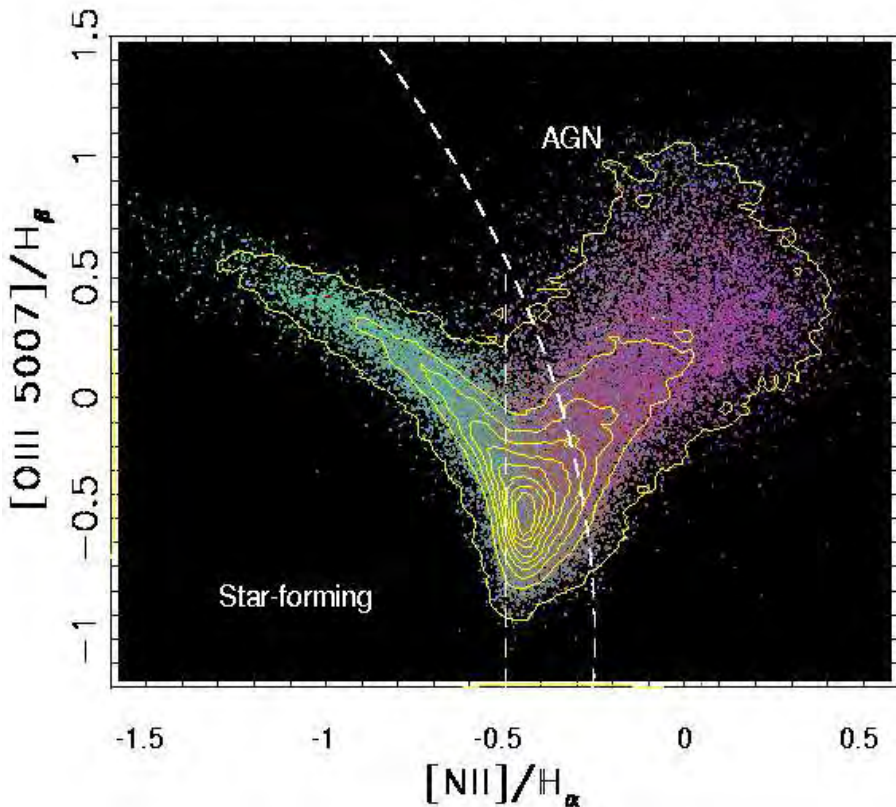
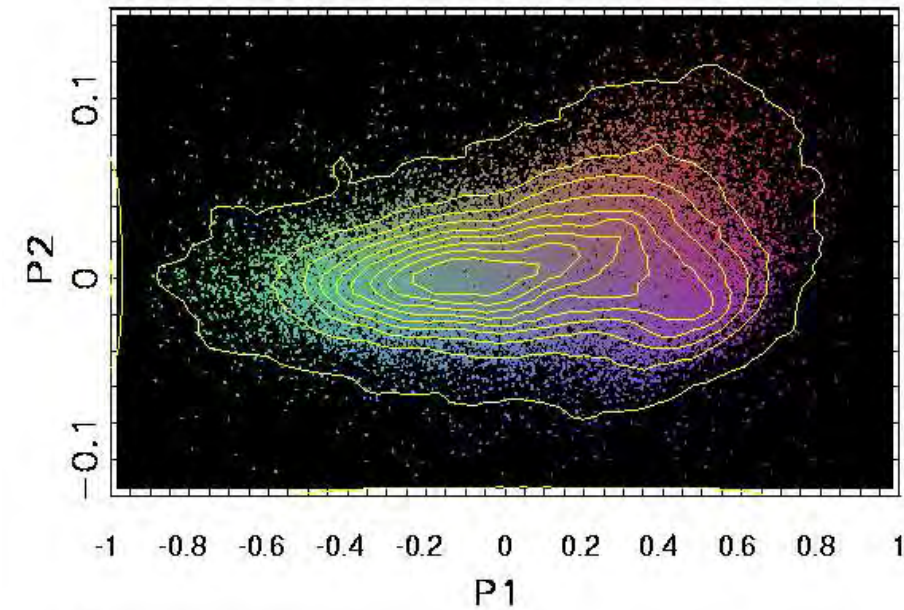

Quasar SEDs

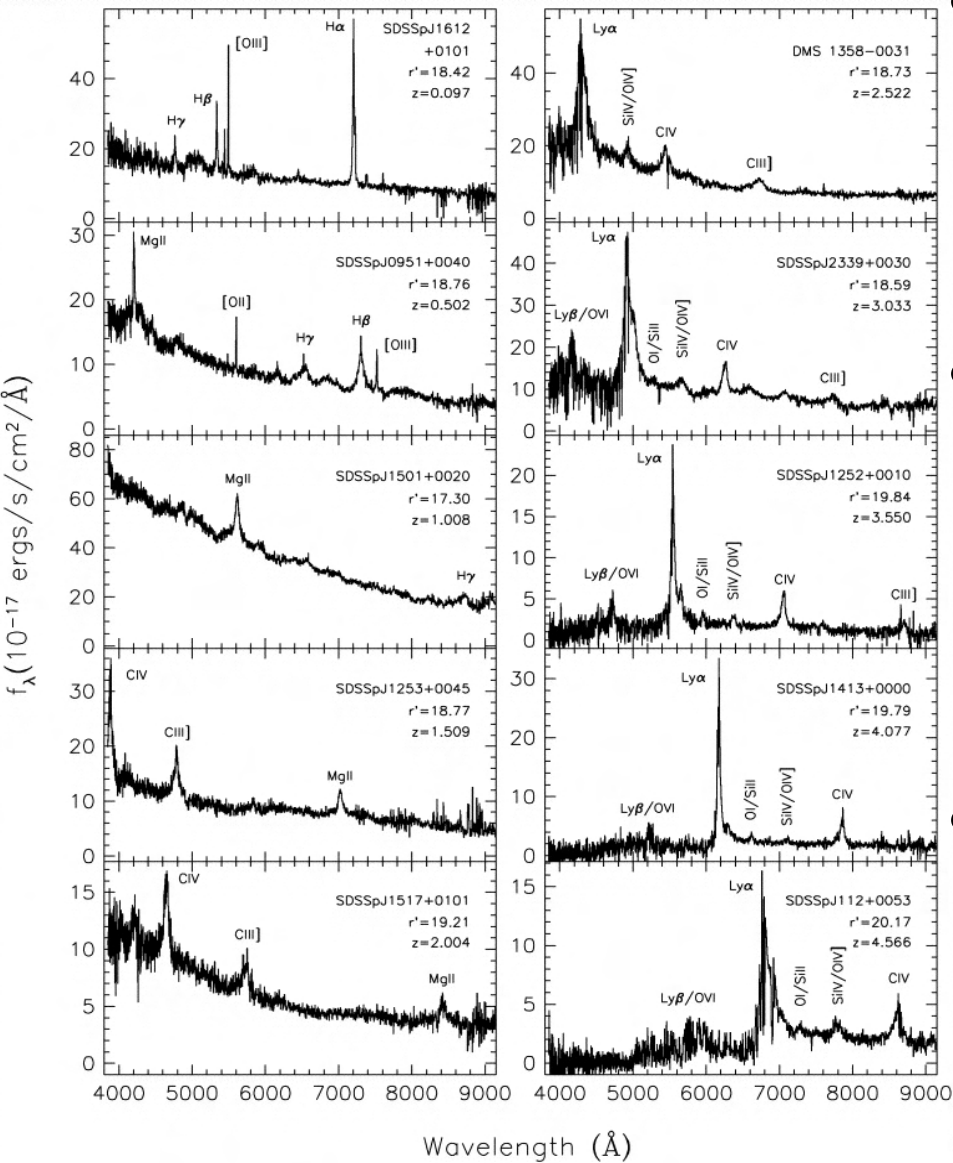

- Quasars are typically at large redshifts (up to ~ 6); **observed SEDs greatly differ** because a given observed wavelength range samples different rest-frame wavelength range
- **First QSOs were detected in radio observations, but only $\sim 10\%$ of QSOs are radio loud** (the remaining 90% have radio fluxes about 100-1000 weaker than those of radio louds, when normalized by optical flux)
- Most modern quasar surveys, including SDSS, select candidates using **optical colors**

Quasar Color Selection

- Quasar SED may produce similar SDSS colors as bluish stars.

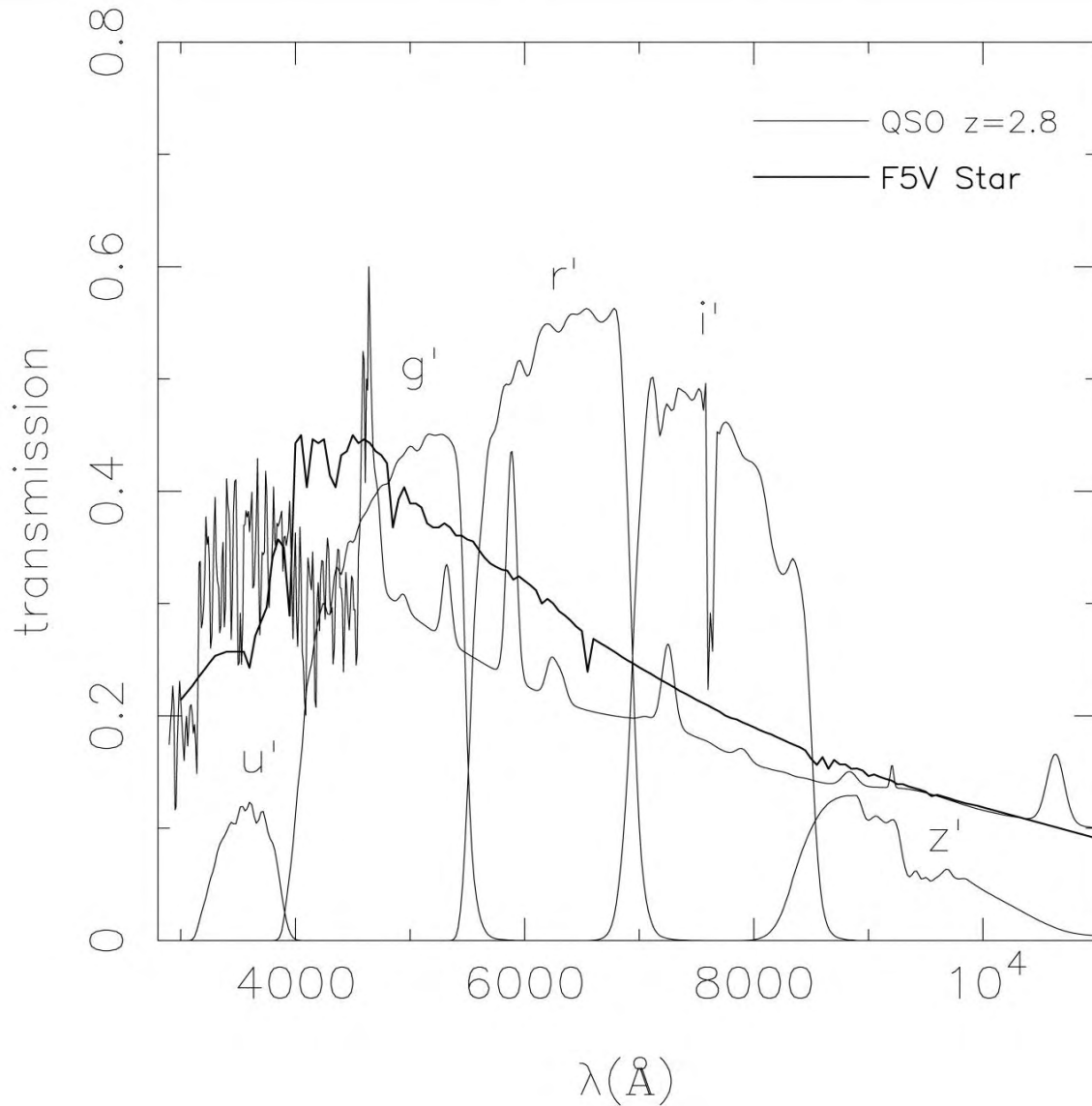

Quasar Color Selection

- K-correction helps to distinguish QSOs from stars

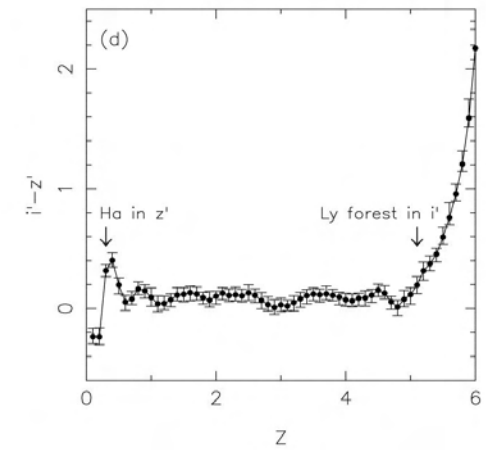
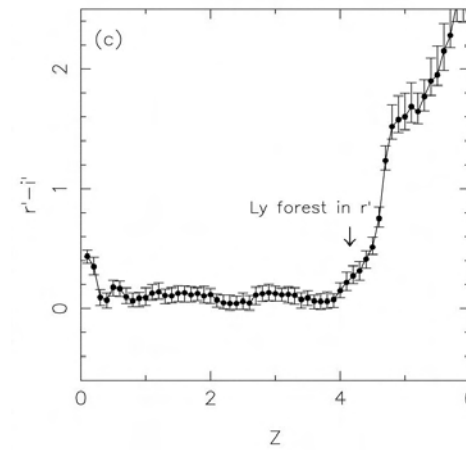
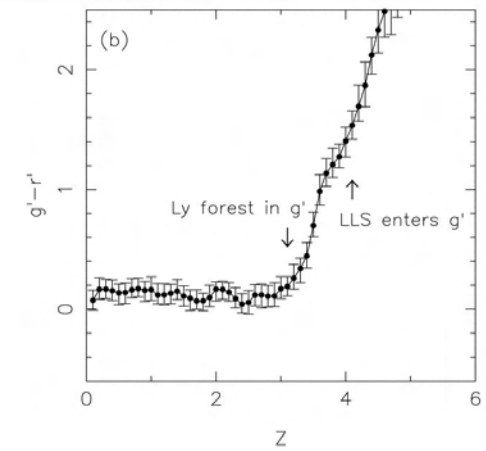
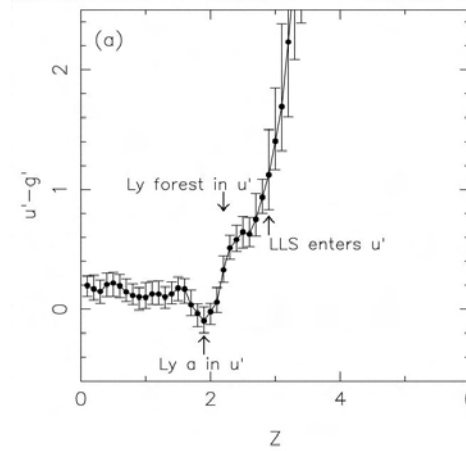
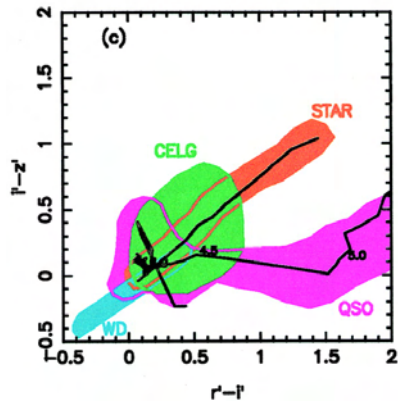
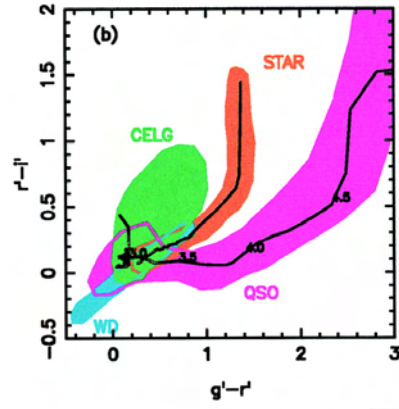
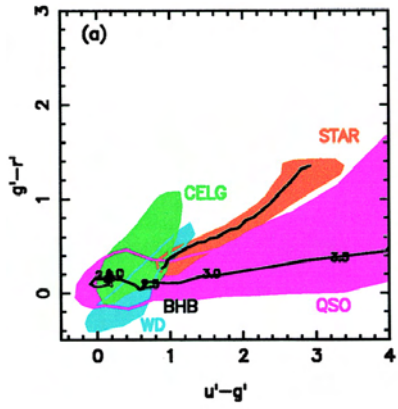

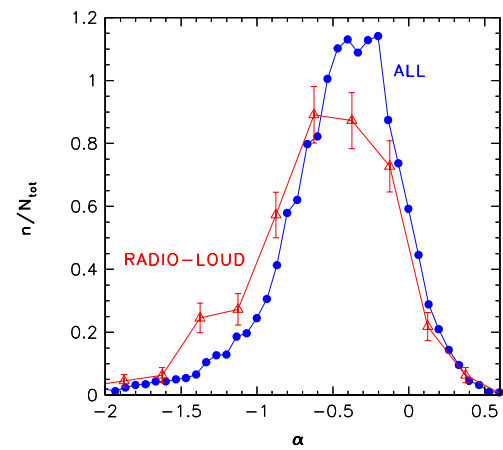
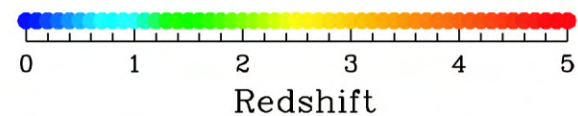
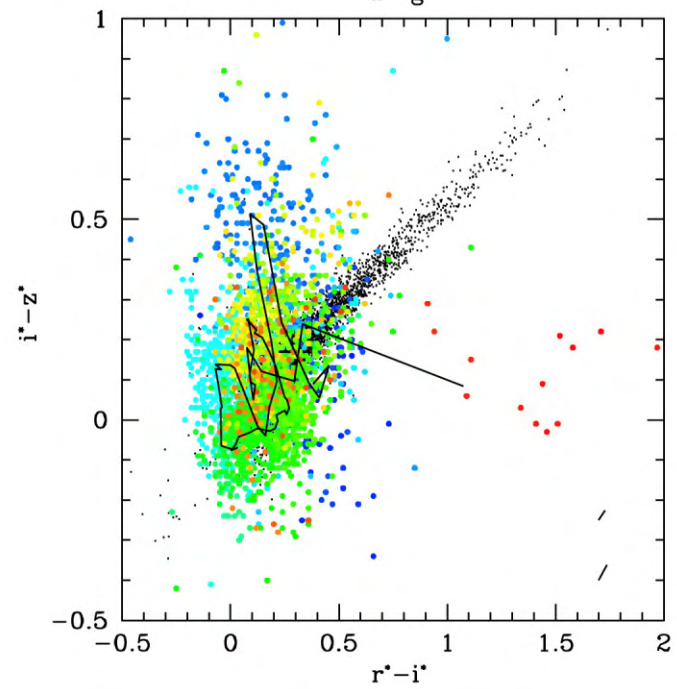
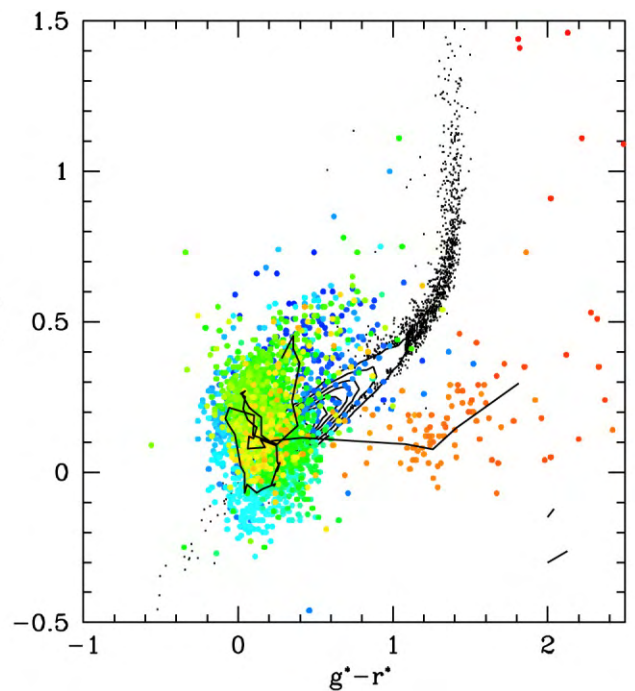
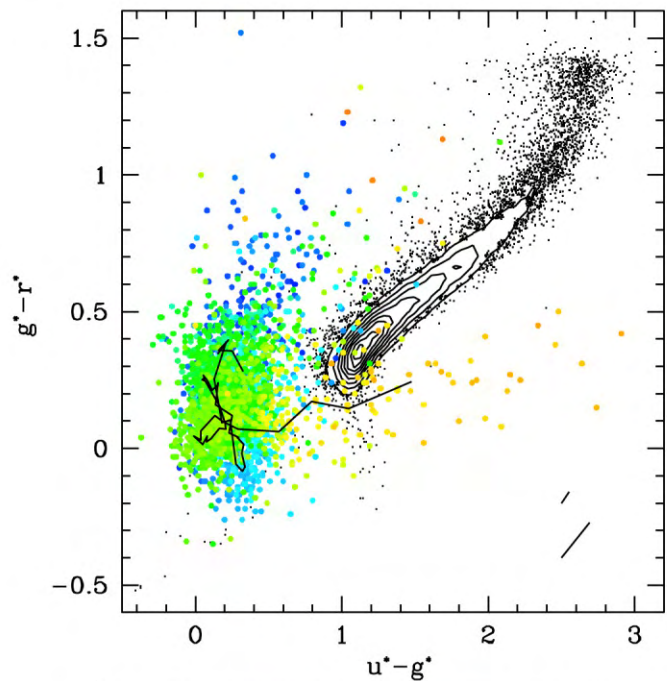

Colors of SDSS quasars

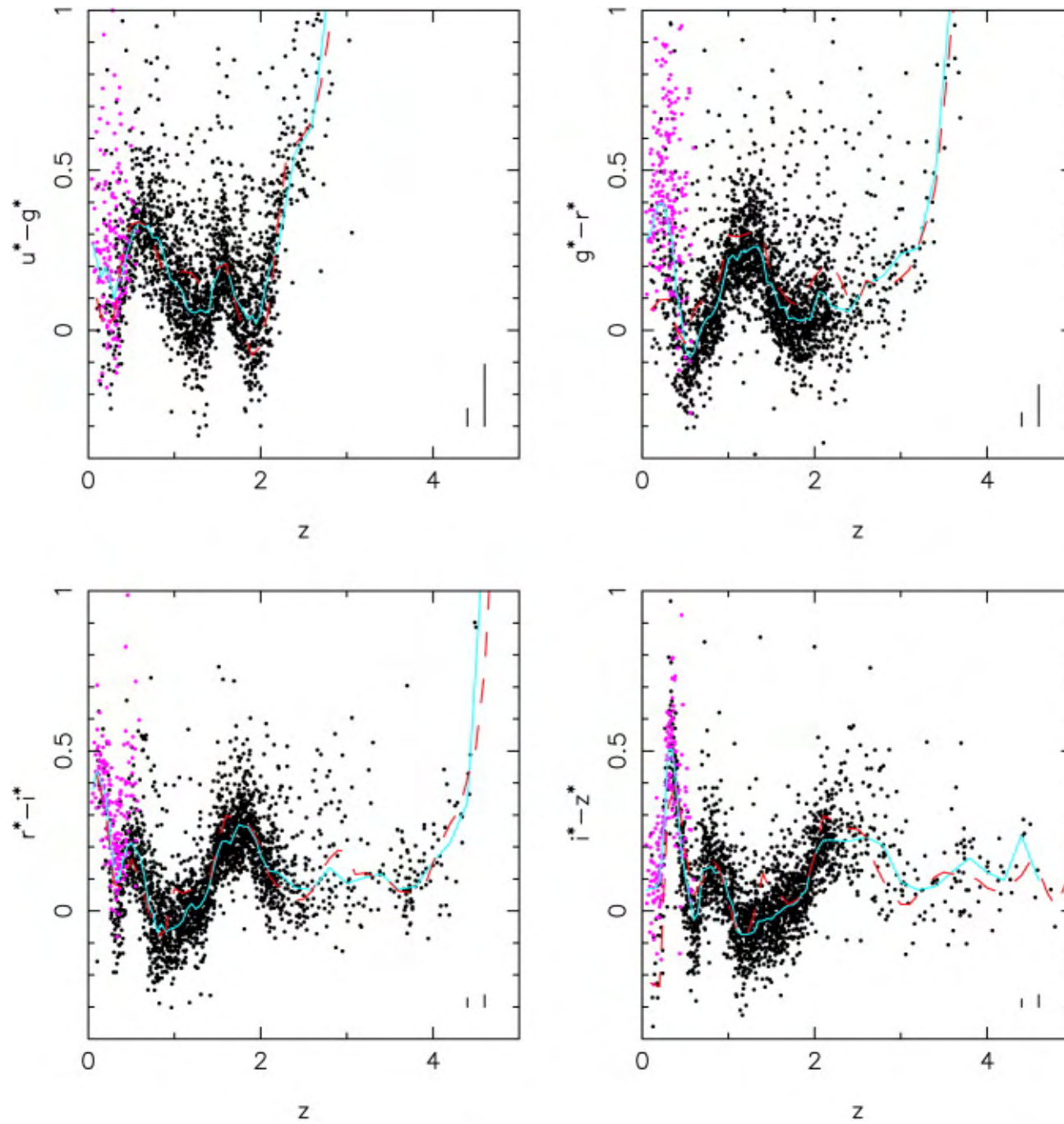

The wiggles are due to emission lines

Observed Quasar SEDs

- Not all quasar SEDs look exactly the same! Dust effects?

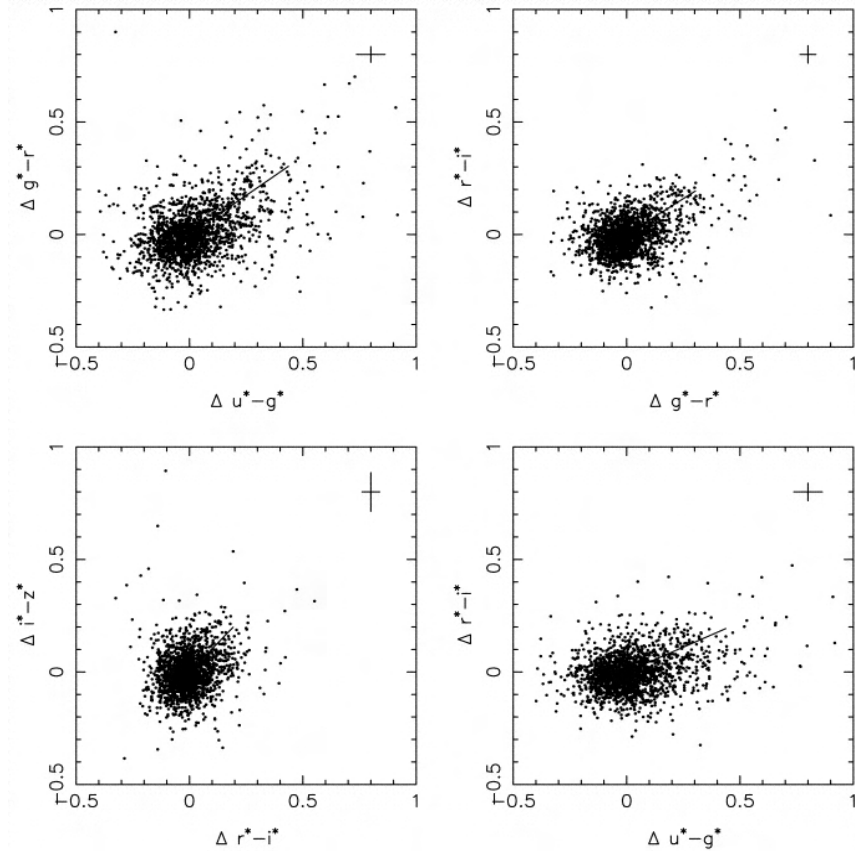
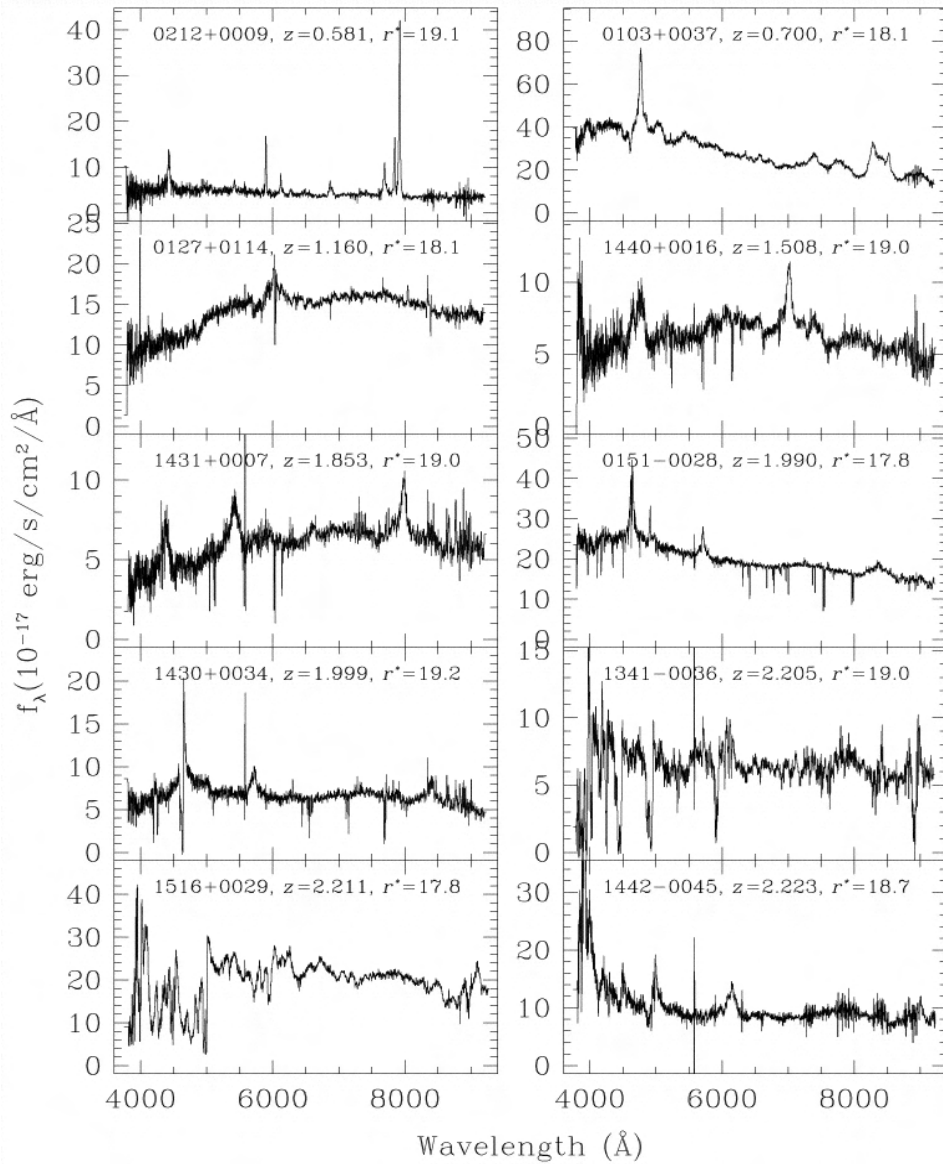

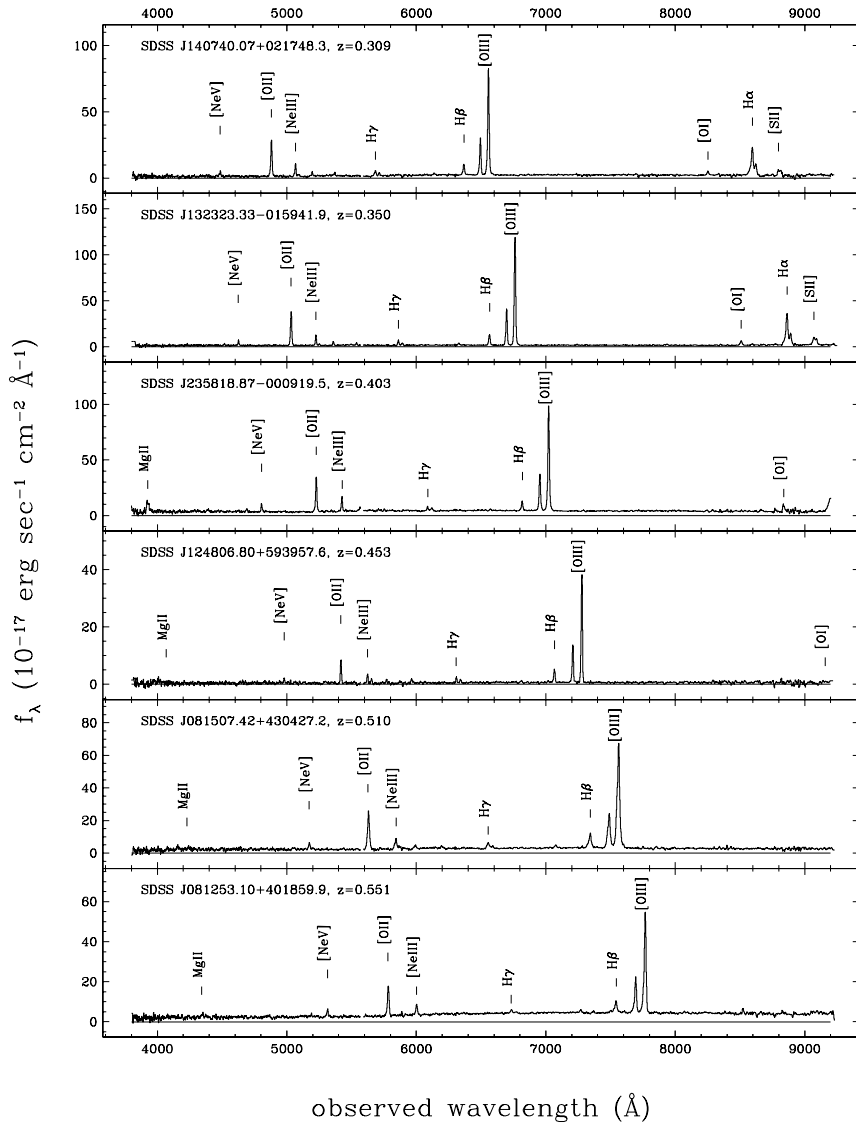
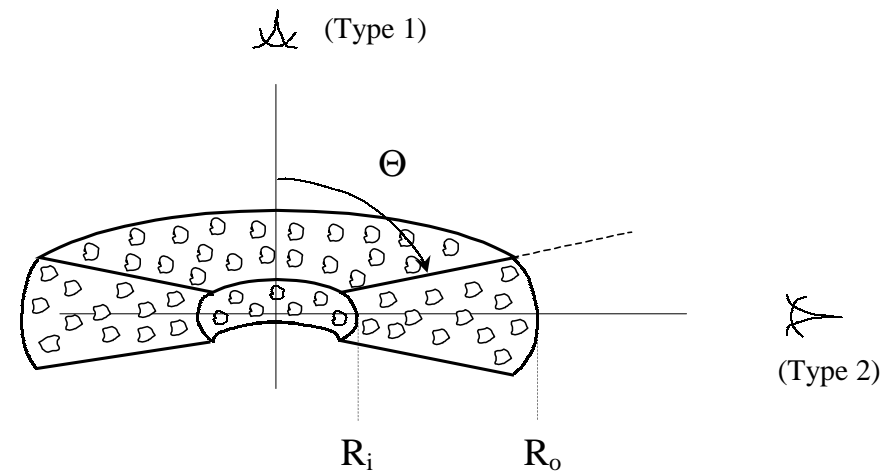

Fig. 1.— Example spectra of type II quasar candidates, $0.3 < Z < 0.6$, smoothed by 5 pixels. The thin line is at the zero flux density level. For this Figure, objects with high line luminosities were chosen ($L[\text{OIII}] > 3 \times 10^8 L_{\odot}$, see Section 6.2).

Observed Quasar SEDs

- SDSS type II QSOs (Zakamska et al 2003): selected by unusual SEDs (mostly optically resolved)
- A significant increase in the number of objects
- Is the central engine really obscured by dust? Multiwavelength studies can answer this question (Zakamska et al 2004)



Quasar Luminosity Function

- The comoving number density is strongly peaked at $z \sim 2-3$!

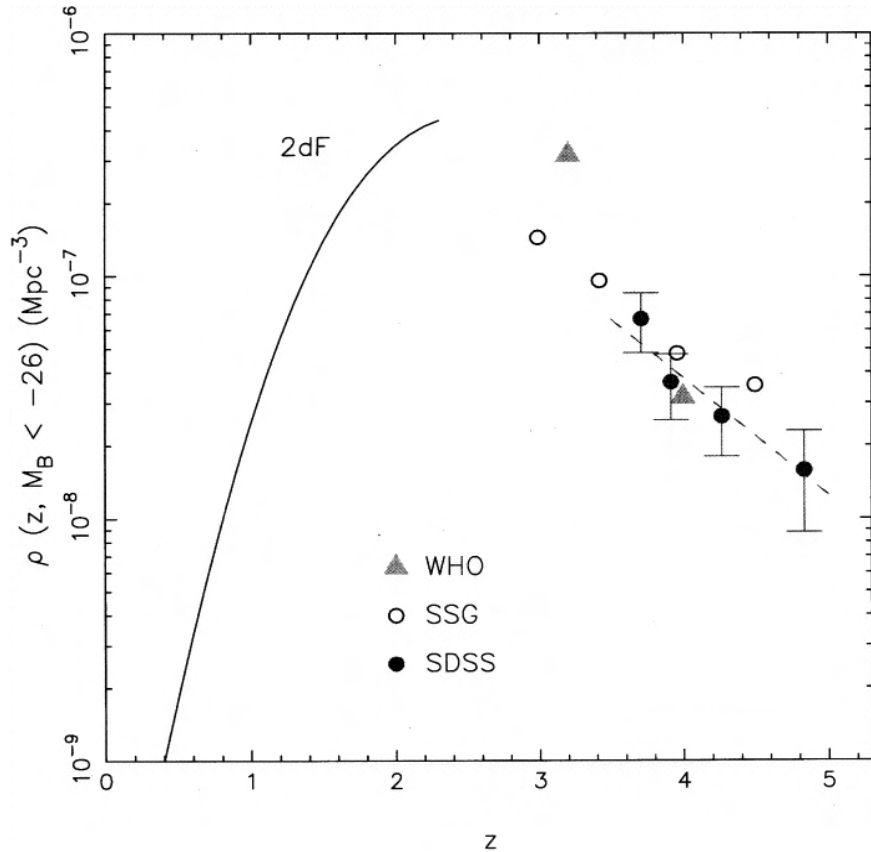

Boyle et al. 2001 (2dF survey): there is a break in LF, its luminosity varies with redshift such that the corresponding apparent magnitude is nearly constant!

The optical QSO luminosity function

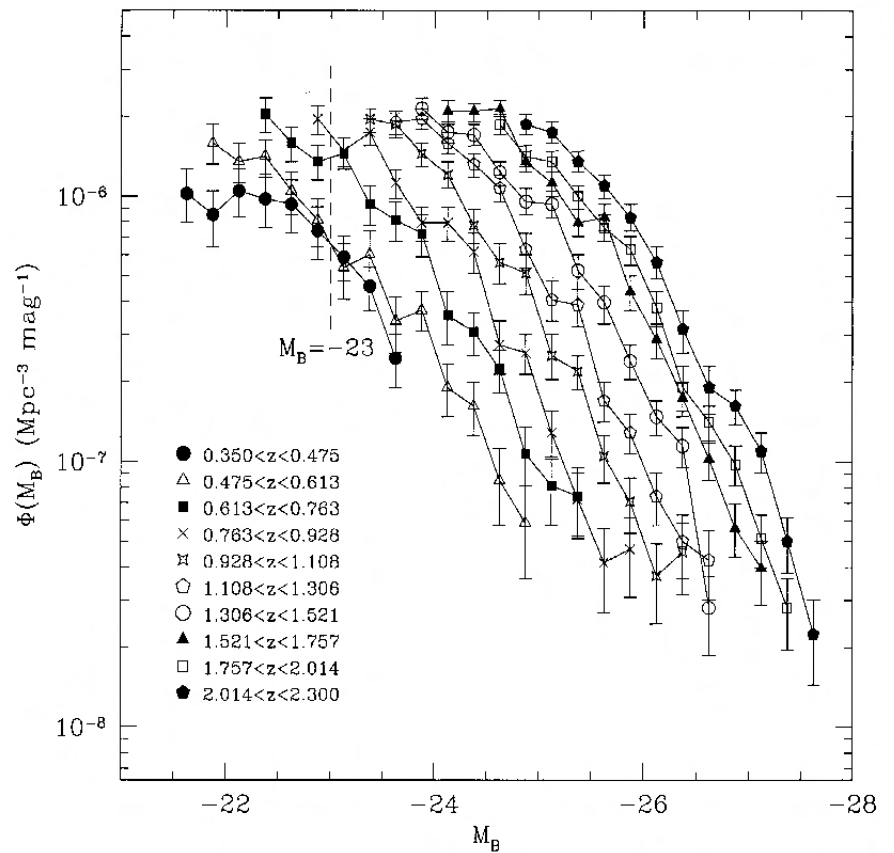

Quasar Variability

- Studied for long time, but the results still controversial
- The minimum set of relevant parameters: **time scale, wavelength, redshift, luminosity** (colors, radio and X ray emission, line widths, etc.)
- Due to large redshifts observed and rest-frame time scales and wavelength significantly different

QSO variability in observed frame. I

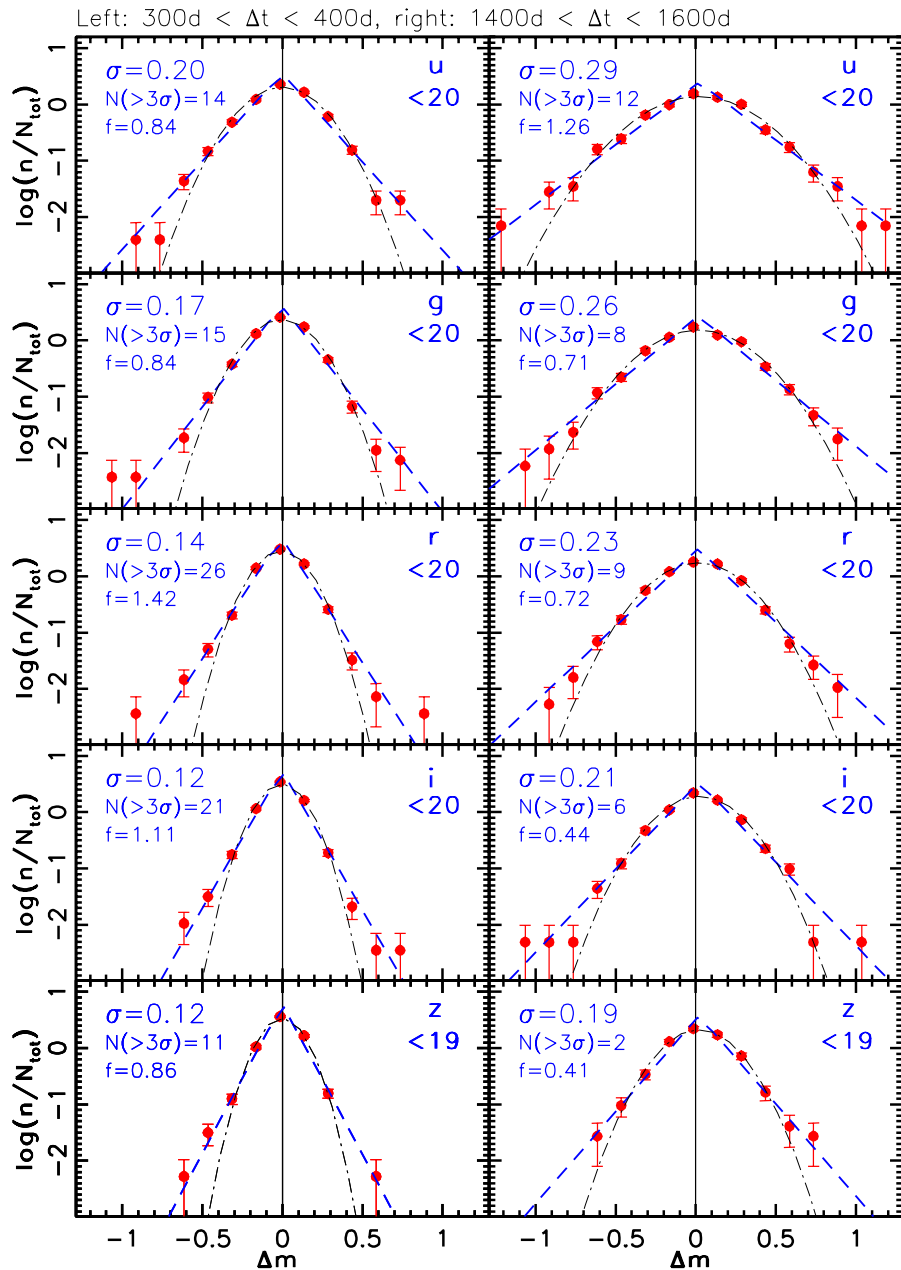

- Exponential (rather than Gaussian), distribution: $p(\Delta m|\lambda, \Delta t) \propto \exp[-|\Delta m|/\Delta_c(\lambda, \Delta t)]$
- Δ_c increases with time
- Δ_c decreases with wavelength
- Δ_c decreases with luminosity
- Δ_c independent of redshift! How can that be?
- What happened to time dilation, $\Delta t_{obs} = \Delta t_{RF} (1 + z)$, and wavelength redshift, $\lambda_{obs} = \lambda_{RF} (1 + z)$??

Structure function for QSO variability

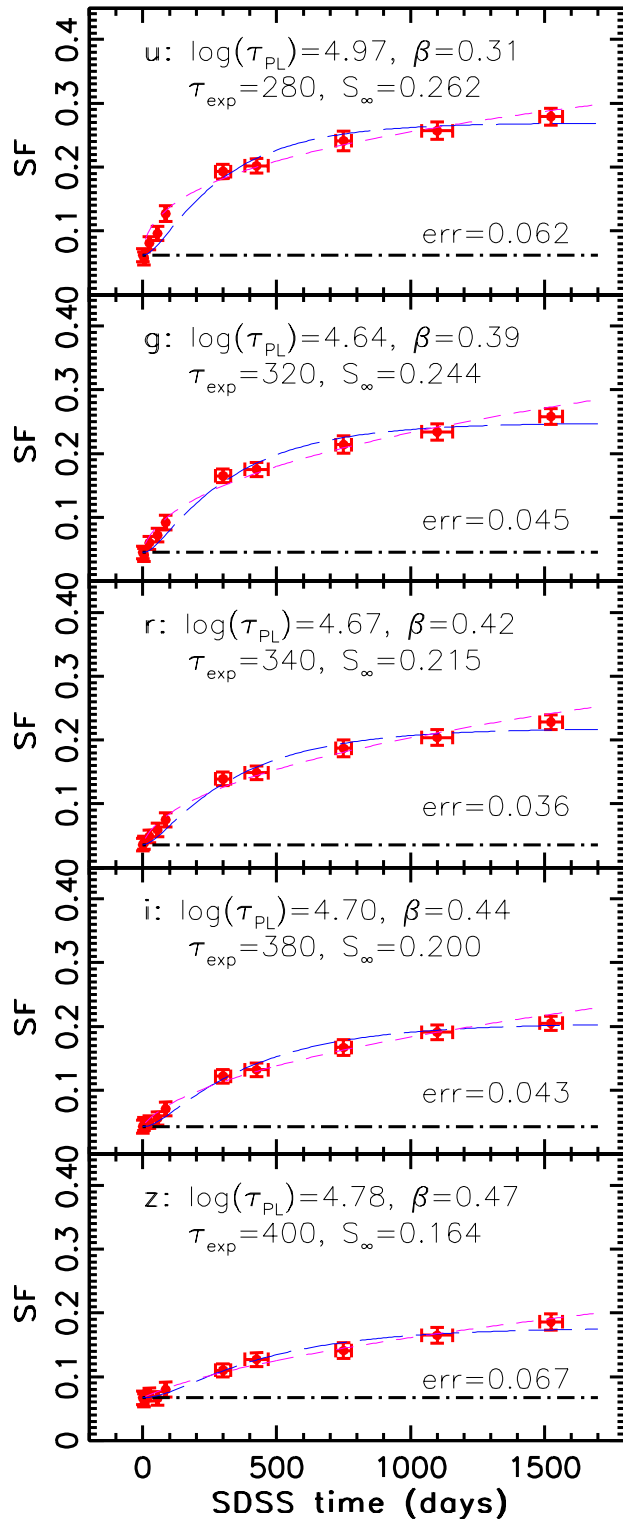

QSO variability in observed frame. II

- Structure function: standard deviation of Δm distribution
 $SF \propto \Delta_c$
- To within errors, described by a power law
 $\Delta_c(t) \propto t^{0.3}$

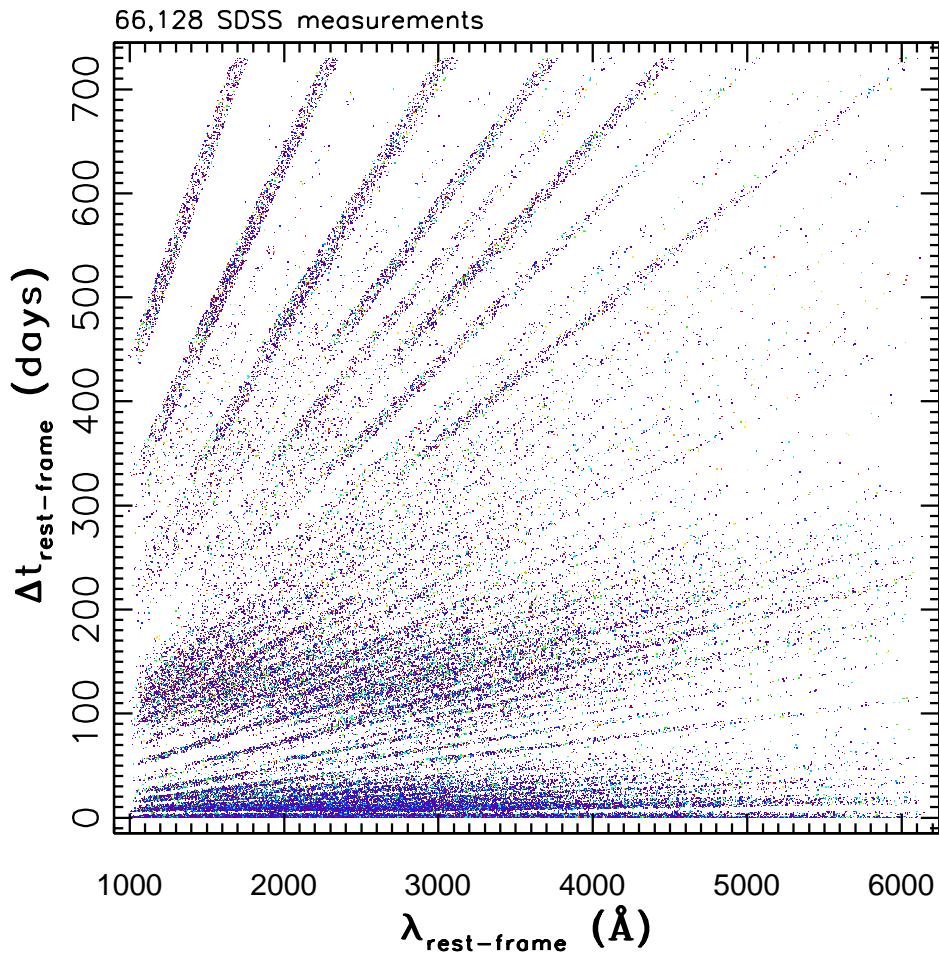

QSO variability in rest frame

- Although there are only five bandpasses, and the time sampling is sparse in the observed frame, the broad redshift distribution provides a good coverage of the Δt_{RF} vs. λ_{RF} plane
- Can bin the Δt_{RF} vs. λ_{RF} plane and compute SF for each bin, as a function of Δt_{RF} , λ_{RF} , M_i redshift
- Using $\lambda_{obs} = \lambda_{RF}(1 + z)$ and $\Delta t_{obs} = \Delta t_{RF}(1 + z)$
- Model (rest frame):

$$SF = A [1 + B M_i] \Delta t^\gamma \lambda^{-\delta} z^\epsilon$$

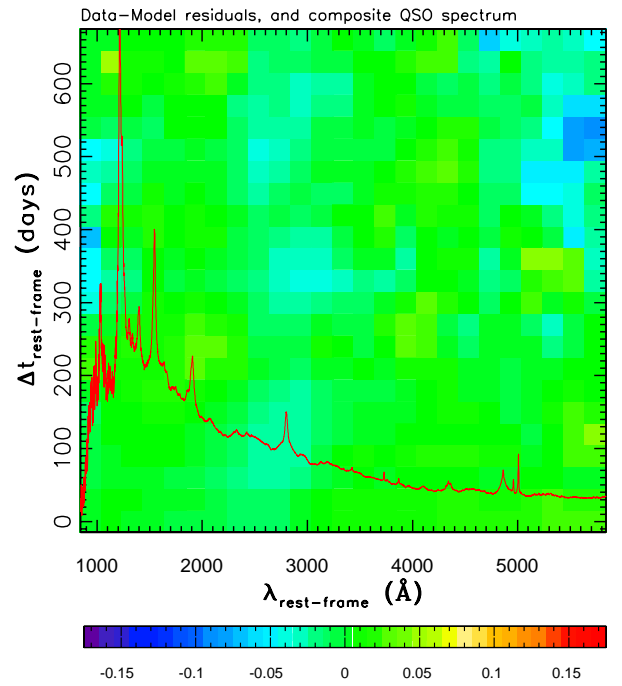
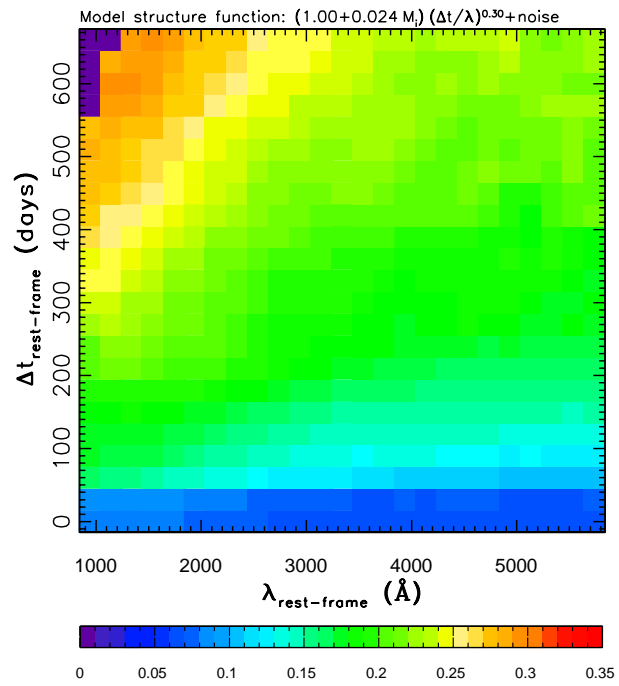
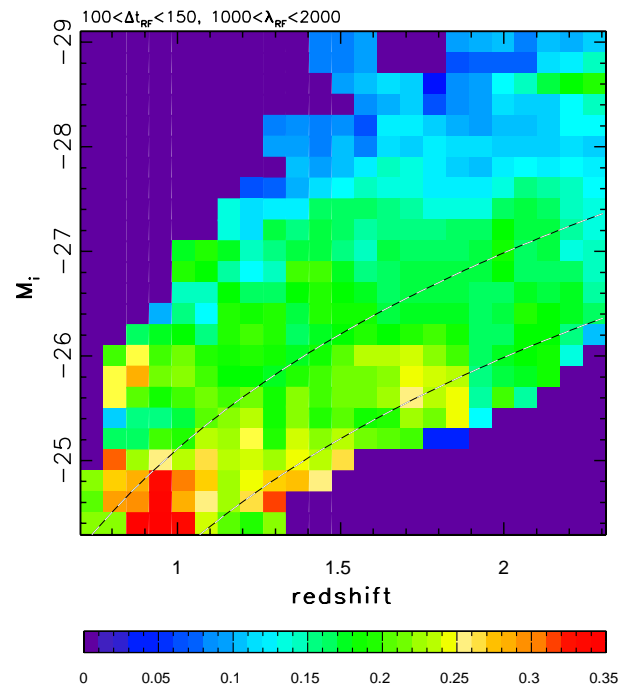
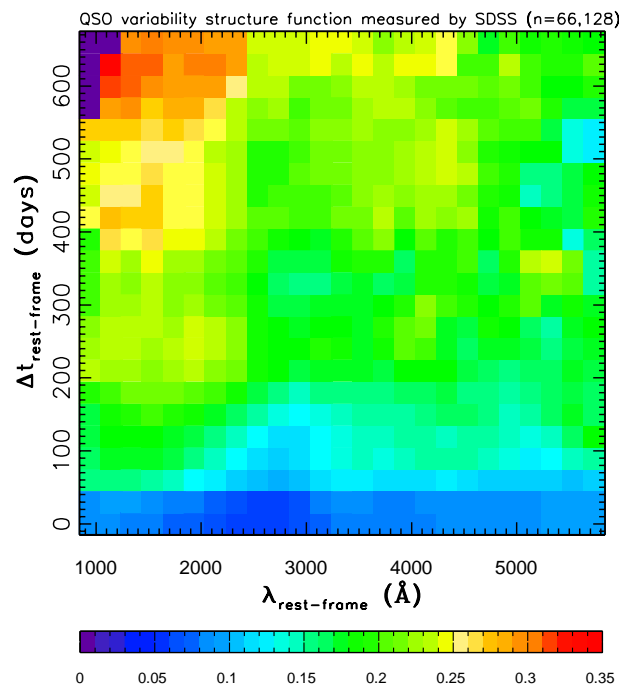

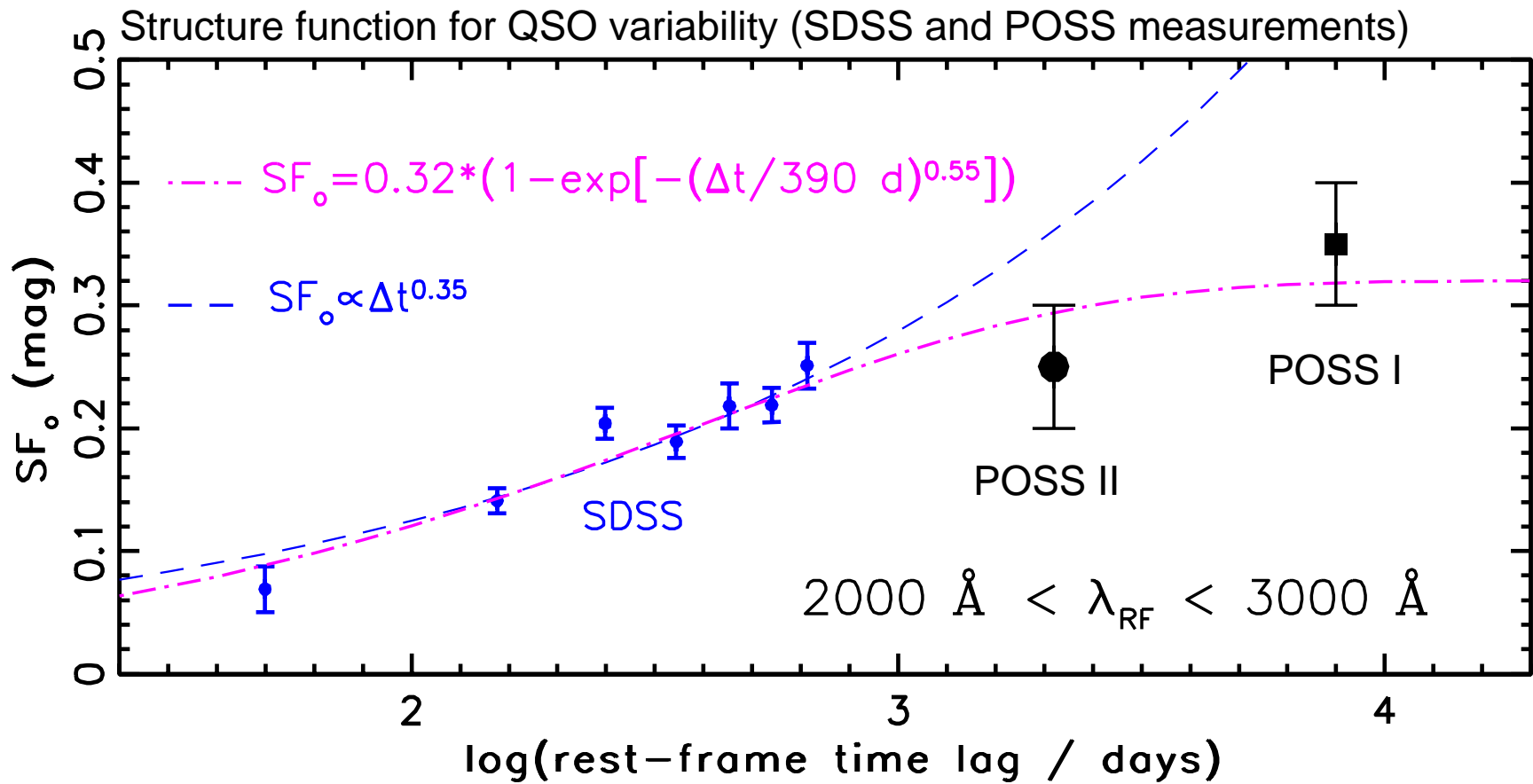

Cosmology with SDSS

Weak Lensing

- Gravitational lensing by foreground galaxies **distorts the shapes** of background galaxies (tangential shear); a **small effect** ($\sim 1\%$), but can be detected statistically with a large sample of galaxies.
- This measurement constrains the **enclosed mass as a function of distance** from the center of the foreground galaxy. Expectation for isothermal sphere: shear $\propto r^{-1}$.
- A **complementary measurement** to other methods for inferring mass.

Weak Lensing Measurements with SDSS

McKay et al. 2002

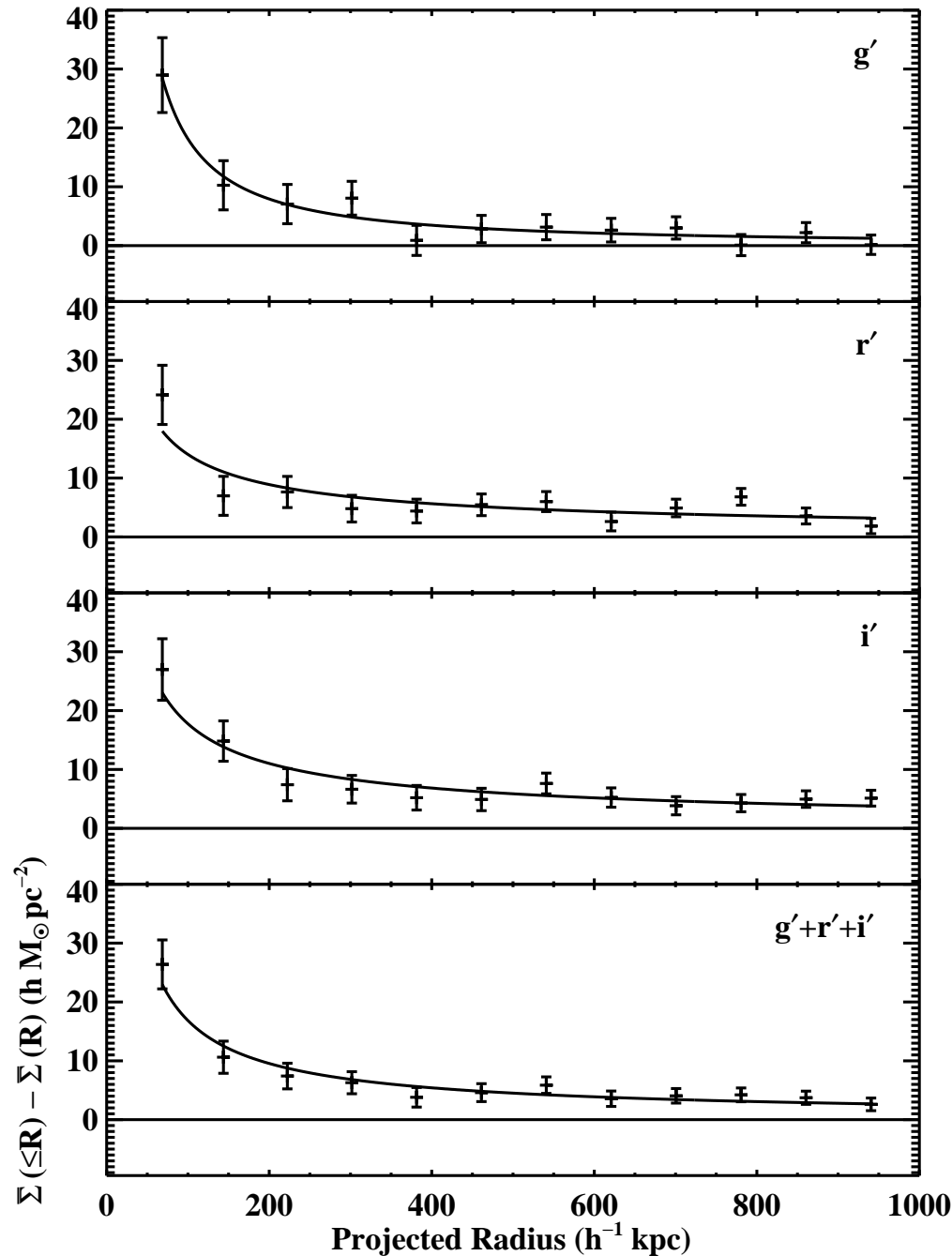

- shear $\propto r^{-0.8 \pm 0.2}$
- mass $\propto L^{1 \pm 0.2}$;
- Tully-Fisher of Faber-Jackson relations predict mass $\propto \sqrt{L}$ for isothermal spheres, models based on NFW profile can be made consistent with mass $\propto L$

Fig. 7.— Mean density contrast measured as a function of projected radius around $\sim 31,000$ SDSS lens galaxies. The plots are the mean density contrast in g' , r' , and i' images from the top, with the combined data on bottom. The solid lines are the best-fitting power laws.

Large-scale distribution of SDSS galaxies

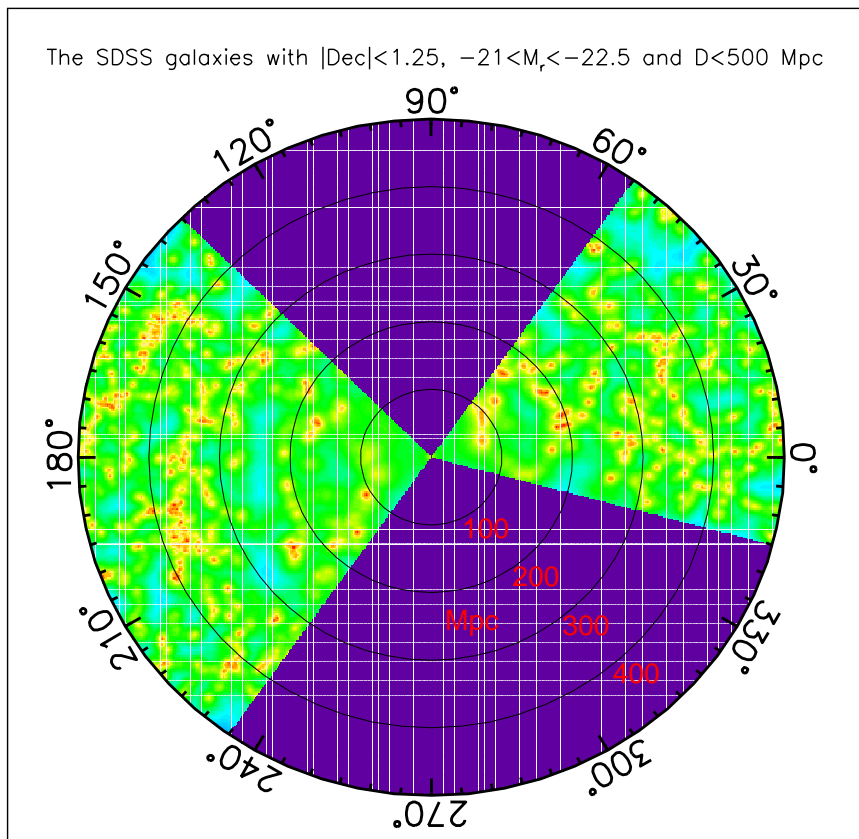
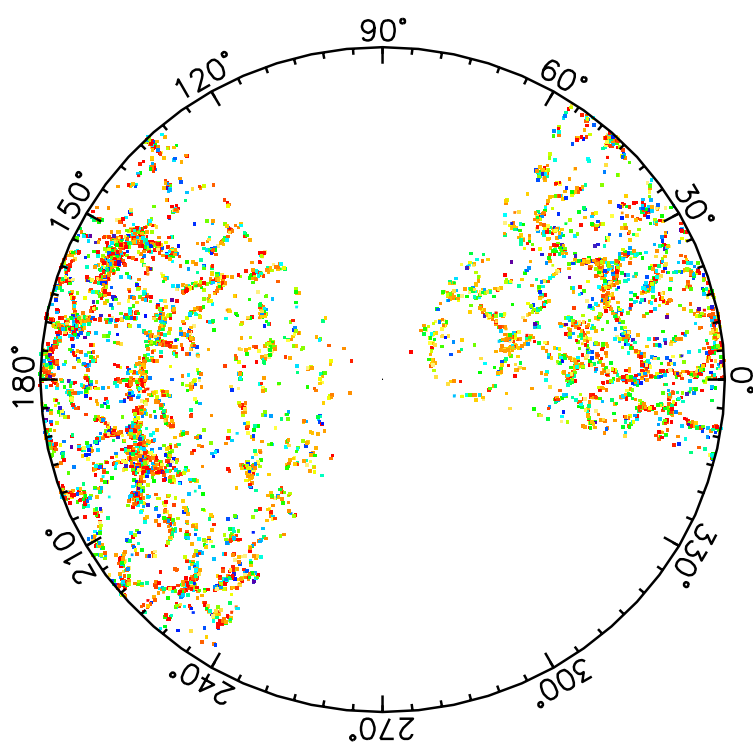

- Top left: each dot is a galaxy with $-22.5 < M_r < -21$ (and $|Dec| < 1.25^\circ$), color-coded by $u - r$ color
- Bottom left: implied number density distribution
- Galaxy distribution is not homogeneous: excess of high density peaks
- Red galaxies more strongly clustered than blue galaxies
- Clustering strength also increase with luminosity

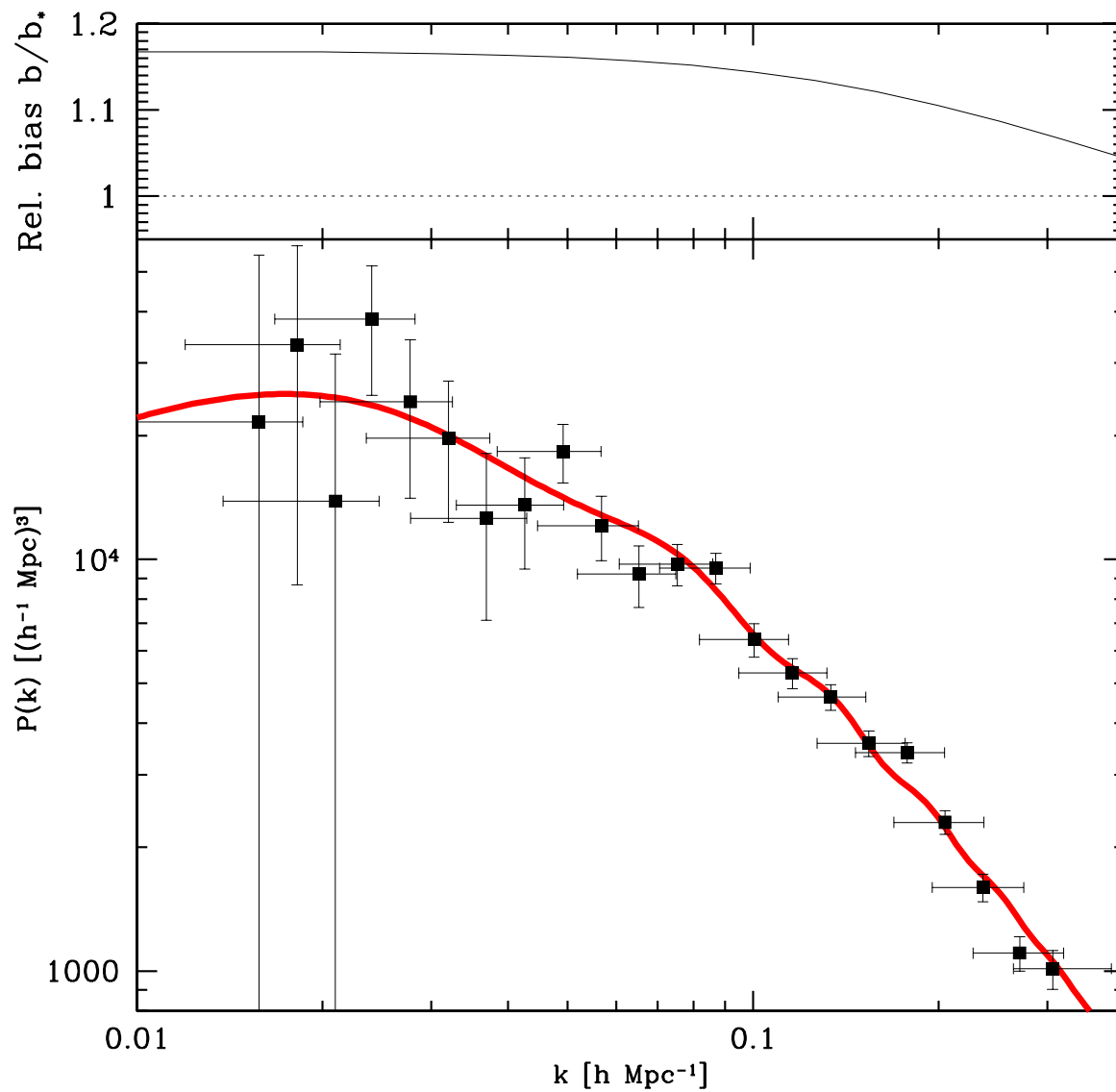

FIG. 22.— The decorrelated real-space galaxy-galaxy power spectrum using the modeling method is shown (bottom panel) for the baseline

Large-scale Structure with SDSS

- **Angular Correlation Function** (Connolly et al. 2002): results consistent with previous results: $\propto r^{-0.7}$ on scales from arcmin to deg.
- **3D Power Spectrum $P(k)$** (Tegmark et al. 2003; Dodelson et al. 2003; Szalay et al. 2003): based on 200,000 galaxies in 2400 deg² ($\langle z \rangle \sim 0.1$)
- **Measurements are well fit by a flat scale-invariant adiabatic cosmological model** with $\Omega_m = 0.201 \pm 0.017$ and $\sigma_8 = 0.93 \pm 0.02$ (with fixed \times baryon fraction $\Omega_b/\Omega_m = 0.17$ and the Hubble parameter $h = 0.72$).

Cosmological Parameters with SDSS

- The accuracy of CMB measurements is improving fast – spectacular accuracy delivered by WMAP
- CMB alone cannot break some degeneracies of cosmological parameters – need non-CMB data.

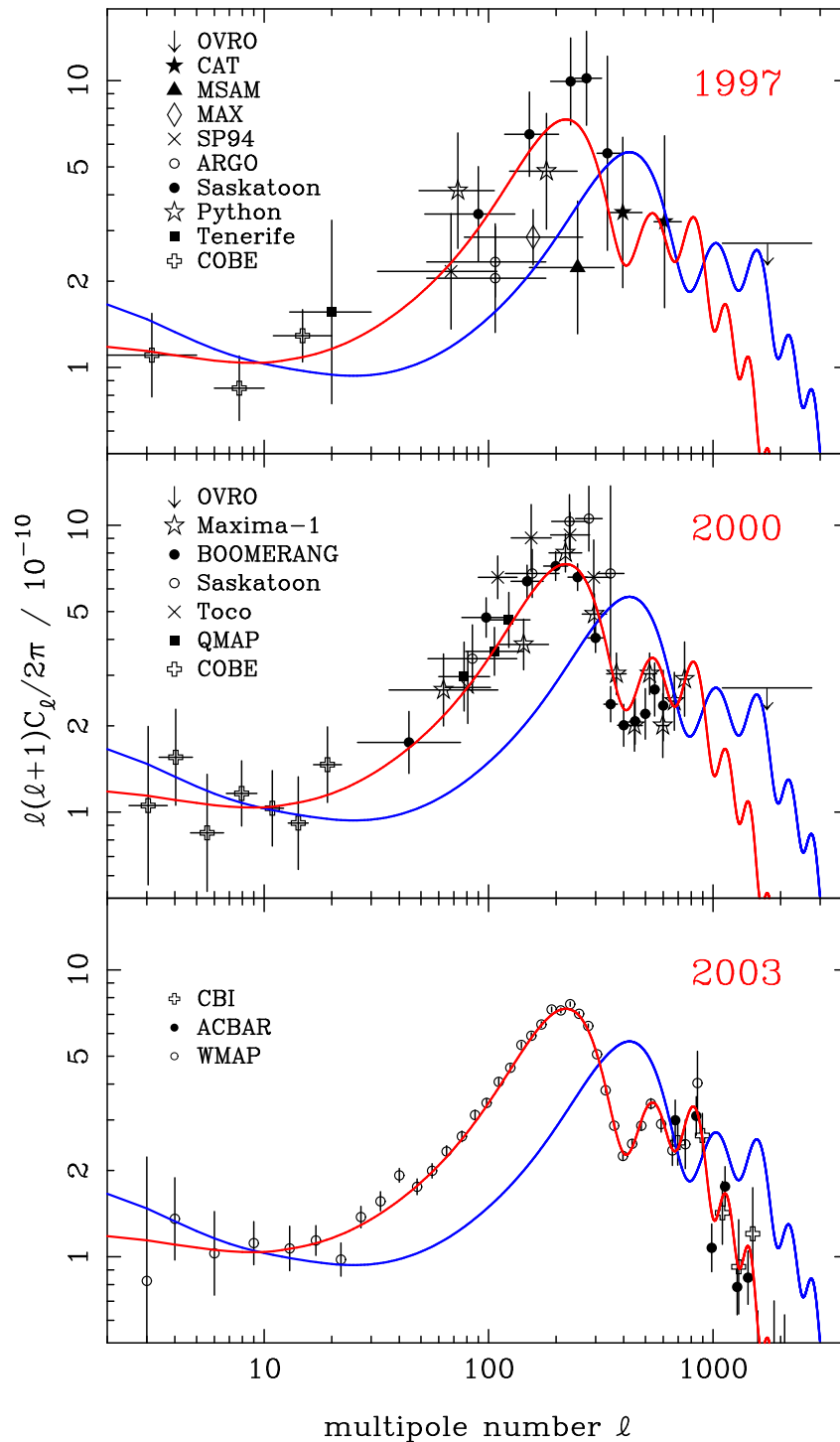

FIGURE 18. Dramatic change took place in CMB power spectrum measurements around the turn of the 21st century. Although some rise from the COBE level was arguably known even by 1997, a clear peak around $\ell \simeq 200$ only became established in 2000, whereas by 2003 definitive measurements of the spectrum at $\ell \lesssim 800$, limited mainly by cosmic variance, had been made

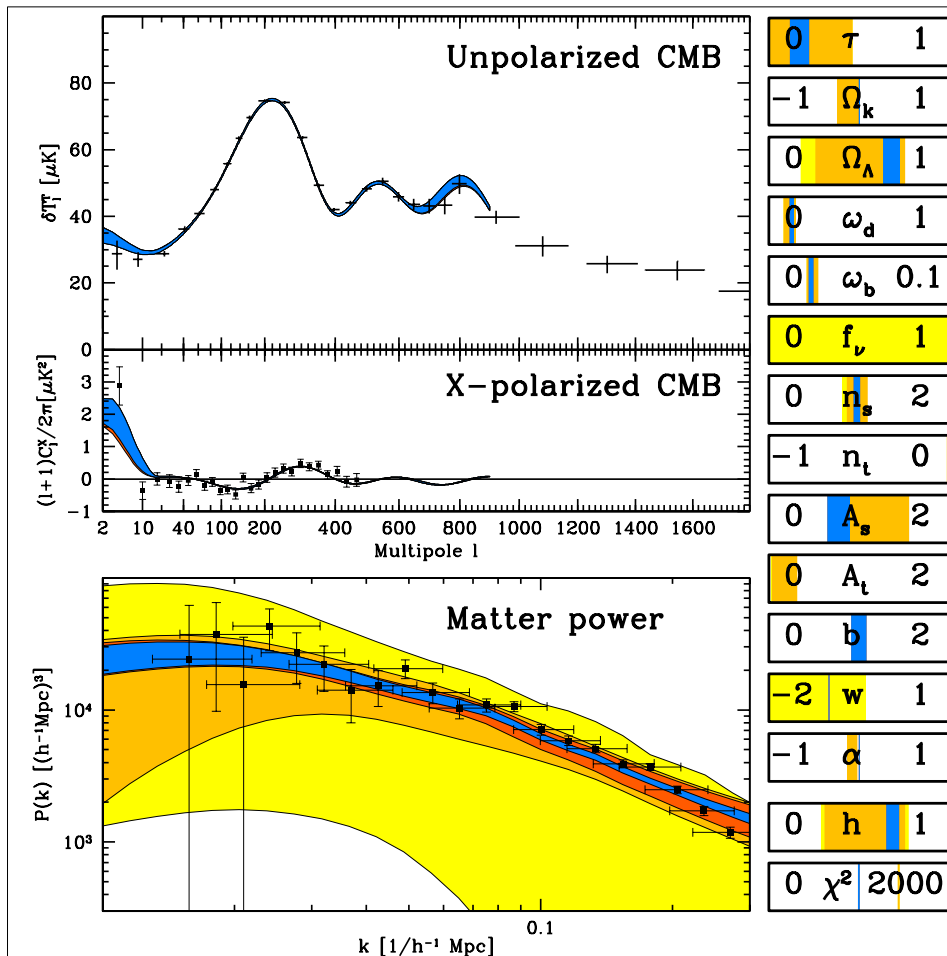

FIG. 1: Summary of observations and cosmological models. Data points are for unpolarized CMB experiments combined (top; Appendix A.3 details data used) cross-polarized CMB from WMAP (middle) and Galaxy power from SDSS (bottom). Shaded bands show the 1-sigma range of theoretical models from the Monte-Carlo Markov chains, both for cosmological parameters (right) and for the corresponding power spectra (left). From outside in, these bands correspond to WMAP with no priors, adding the prior $f_\nu = 0$, $w = -1$, further adding the priors $\Omega_k = r = \alpha = 0$, and further adding the SDSS information, respectively. These four bands essentially coincide in the top two panels, since the CMB constraints were included in the fits. Note that the ℓ -axis in the upper two panels goes from logarithmic on the left to linear on the right, to show important features at both ends, whereas the k -axis of the bottom panel is simply logarithmic.

Cosmological Parameters with SDSS

- The accuracy of CMB measurements is improving fast – spectacular accuracy delivered by WMAP
- CMB alone cannot break some degeneracies of cosmological parameters – need non-CMB data.
- Non-CMB measurements are “the weakest link in the quest for precision cosmology” (Tegmark et al. 2004)

Cosmological Parameters with SDSS

Tegmark et al. 2004

- SDSS helped to constrain the allowed range of cosmological parameters

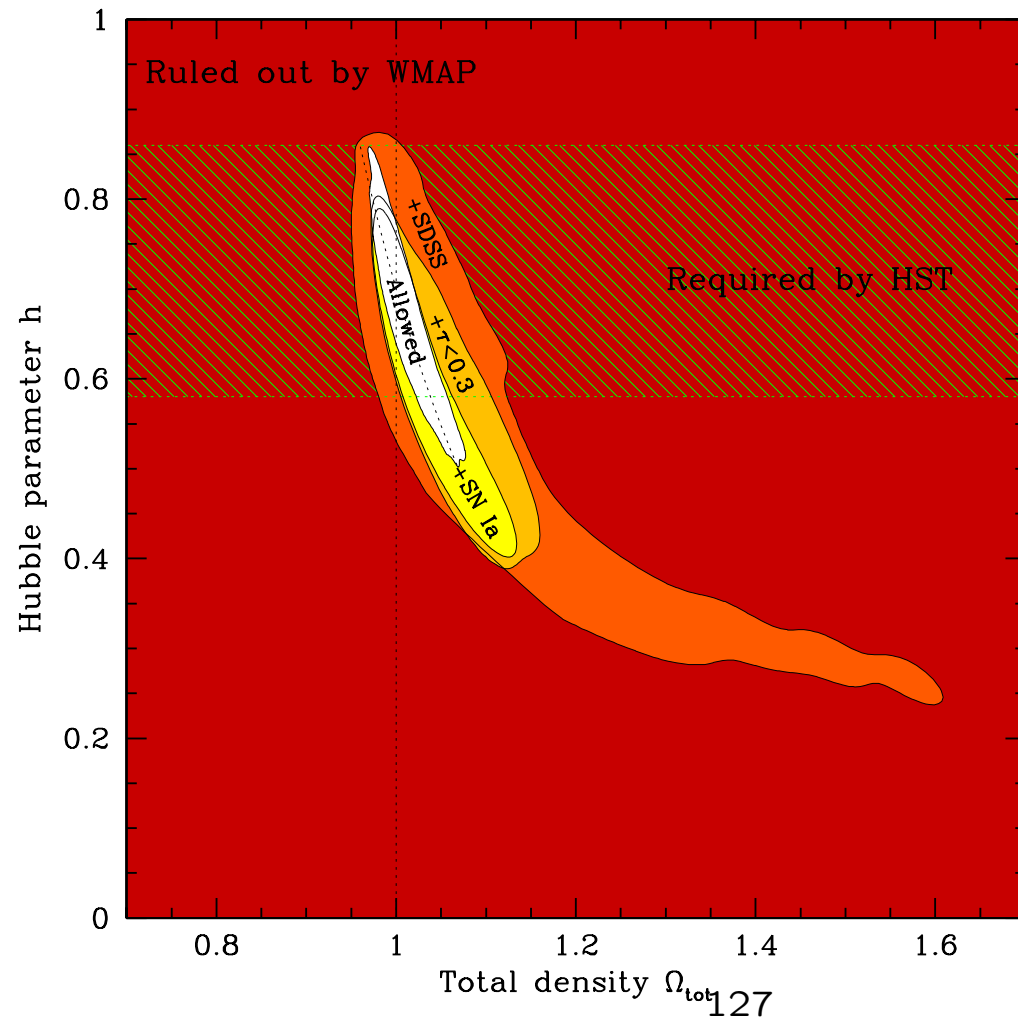
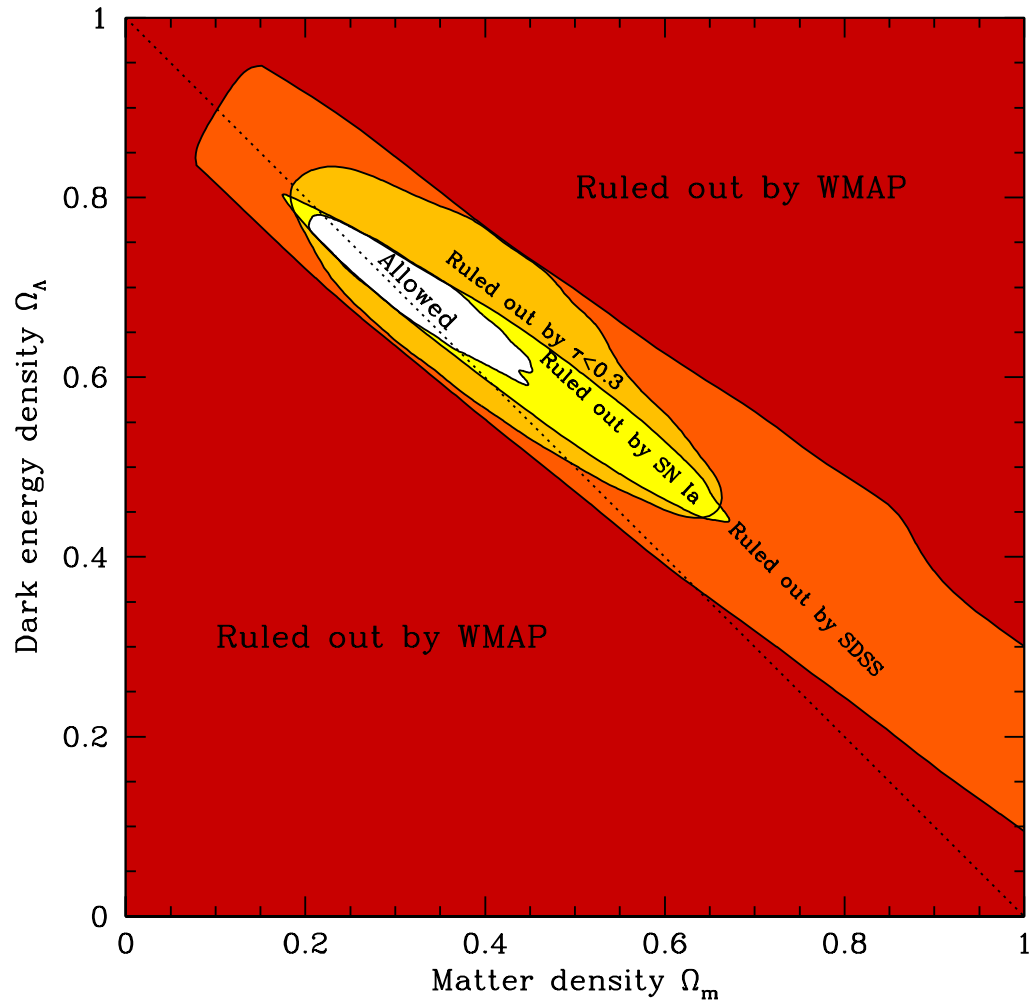

CMB

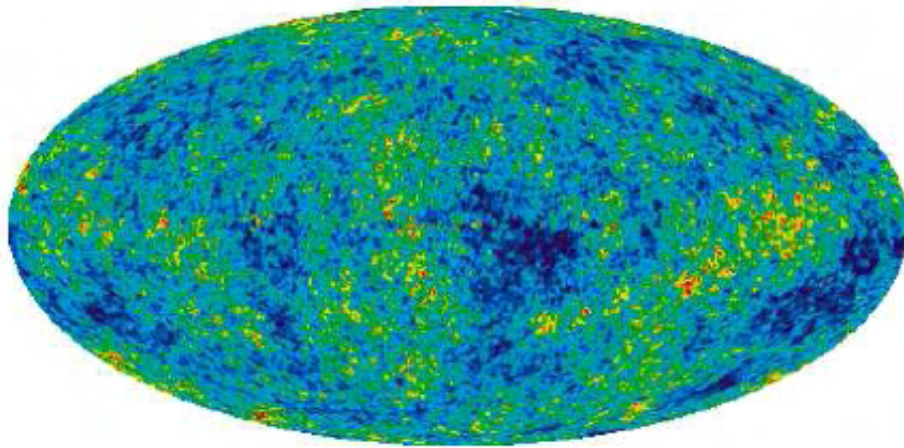

Galaxies

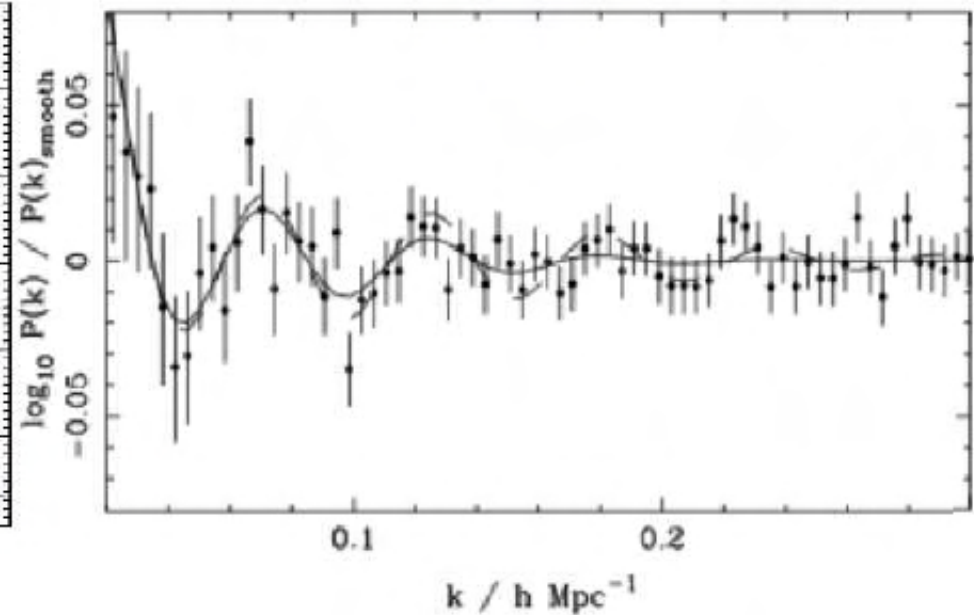
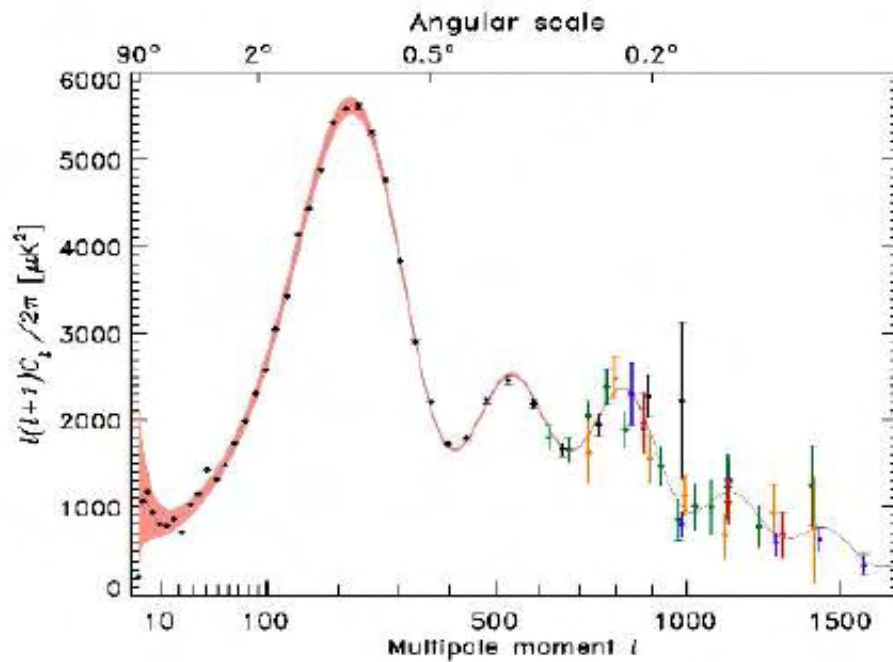
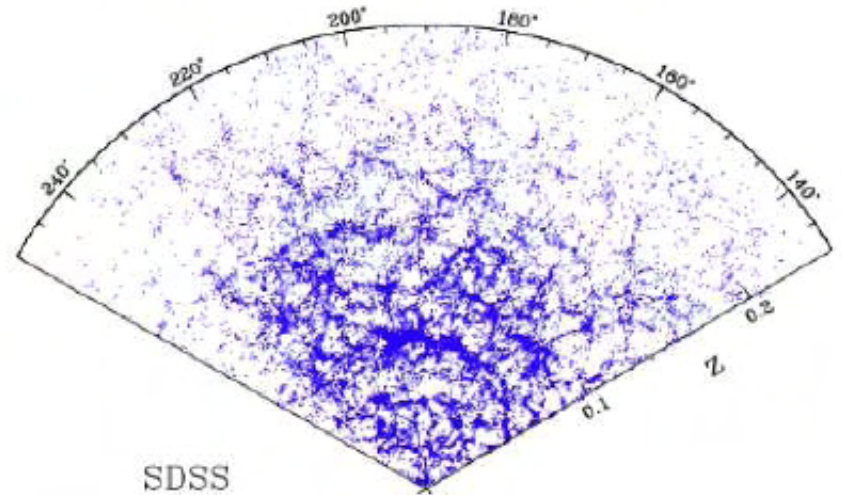

Baryon acoustic oscillations: standard ruler – new cosmological tool from SDSS (and 2dF)

Lecture IV

1. Surveys at non-optical wavelengths

- What SDSS sources are detected at other wavelengths
- Examples of science enabled by multi-wavelength catalogs

2. “The next-generation SDSS”: LSST

- Motivation for an all-sky, deep, time-domain survey
- Anticipated science themes

M81 – Spiral Galaxy (Type Sb)

Distance: 12,000,000 light-years (3.7 Mpc)

Image Size = 14 x 14 arcmin

Visual Magnitude = 6.9

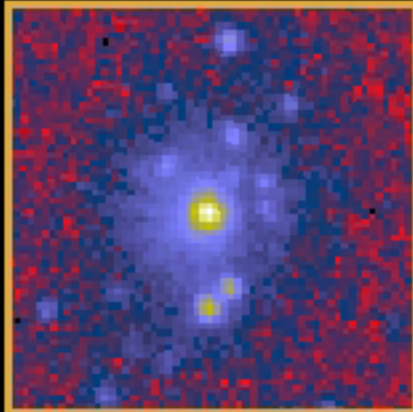

X-Ray: ROSAT

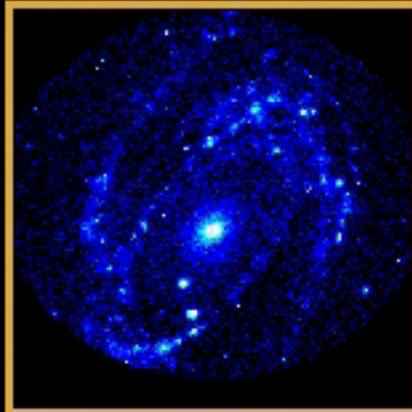

Ultraviolet: ASTRO-1



Visible: DSS



Visible: R. Gendler



Near-Infrared: Spitzer



Mid-Infrared: Spitzer



Far-Infrared: Spitzer

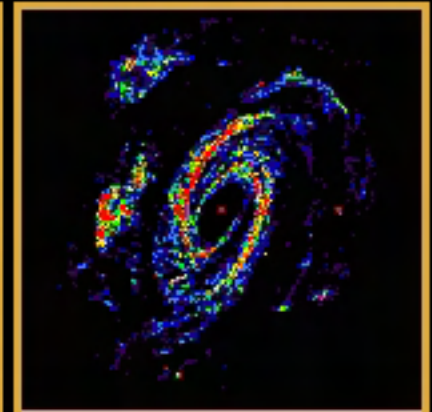

Radio: VLA

Large Surveys at Many Wavelengths

- **SDSS**: UV-IR five-band photometry for 100 million galaxies and 1 million quasar candidates, spectra for 1 million galaxies and 100,000 quasars
- **2MASS**: near-IR (JHK) for 1.65 million resolved sources, and 471 million point sources
- **GALEX**: far-UV (2 bands: 0.12 and 0.22 μm), all-sky survey to $m_{AB} \sim 20.5$, 4 deg² to $m_{AB} \sim 26$, spectroscopy for $\sim 100,000$ galaxies, angular resolution 4-6 arcsec
- **ROSAT, Chandra, XMM**: X-rays (soft and hard), energetic processes, hard X-rays penetrate dust (important for AGNs)
- **IRAS, ISO, Spitzer**: dust emission, high-redshift sources
- **FIRST, NVSS, WENSS, GB6**: Radio surveys, good for AGNs

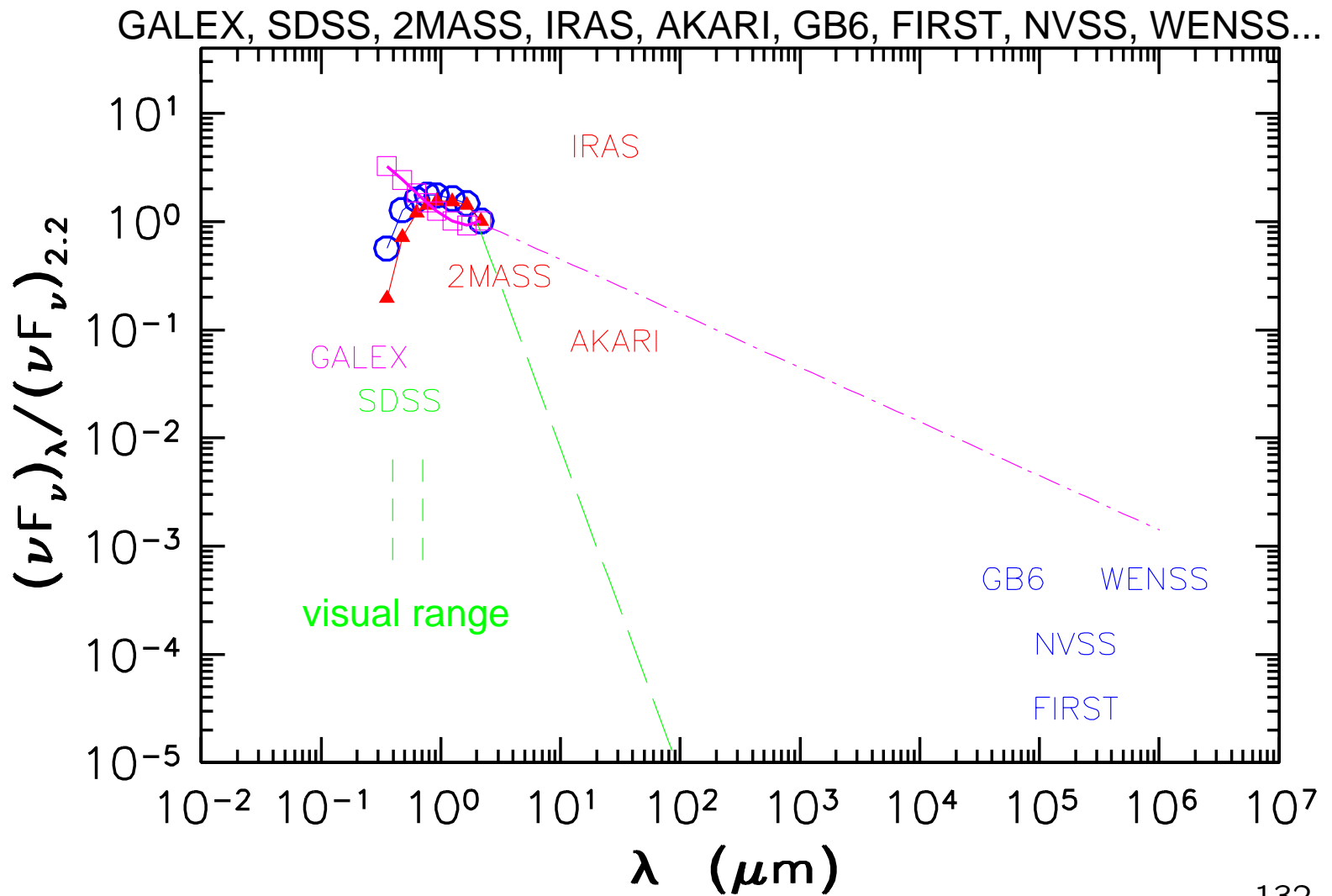

Main Points

- **Entering an Era of Large Accurate Surveys at Many Wavelengths:** Chandra/Champ, GALEX, SDSS, 2MASS, FIRST, many more... (exceedingly complex data for literally hundreds of millions sources, sub-arcsec astrometry)
- **Analysis of cross-correlated catalogs produced by these surveys will enable science that is not possible using individual catalogs** (e.g. stars with normal optical colors that have X-ray, or dust and non-thermal emission from galaxies)
- **SDSS stands out** because it is an optical survey – the wavelength range with the highest information content – **optical identifications** (5 colors and $> 10^6$ spectra)

Outline

1. What types of optical (SDSS) sources are detected by
 - Chandra/Champ (X-ray)
 - GALEX (near- and far-UV)
 - 2MASS (near-IR)
 - FIRST (radio)
2. Examples of science enabled by cross-correlated catalogs:
 - Radio “color-color” diagrams
 - Many-D color-color diagrams and (e.g.) galaxy SEDs

SDSS Sources

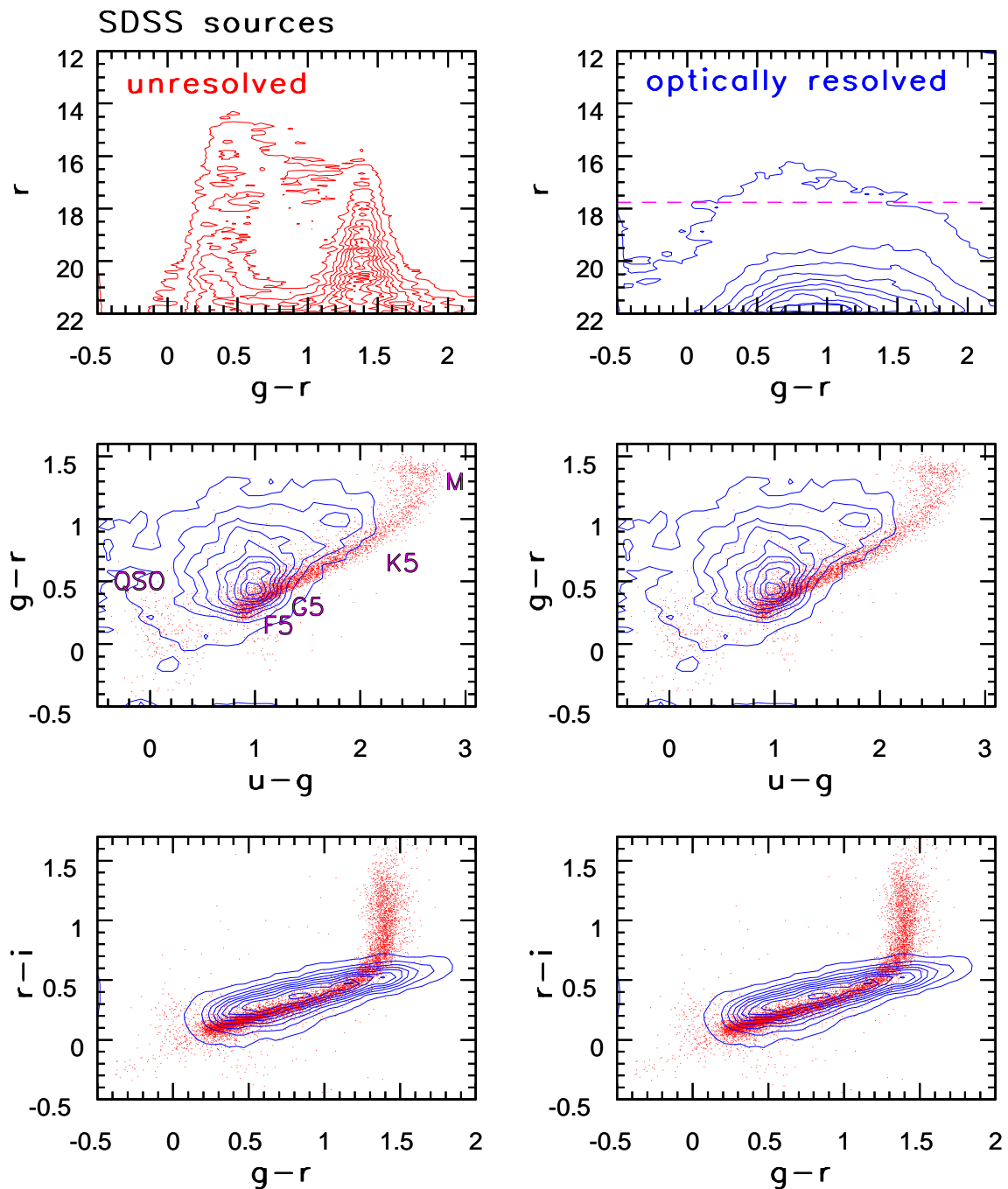

- A summary of SDSS sources: unresolved sources (stars and quasars) in the left column, and resolved sources (galaxies) in the right column.
- Which of these SDSS sources are detected at other wavelengths? Requiring a detection at a non-optical wavelength does NOT select a random subset of SDSS sources; rather, the distribution of such sources in the SDSS color-magnitude and color-color diagrams reveals rich information about them

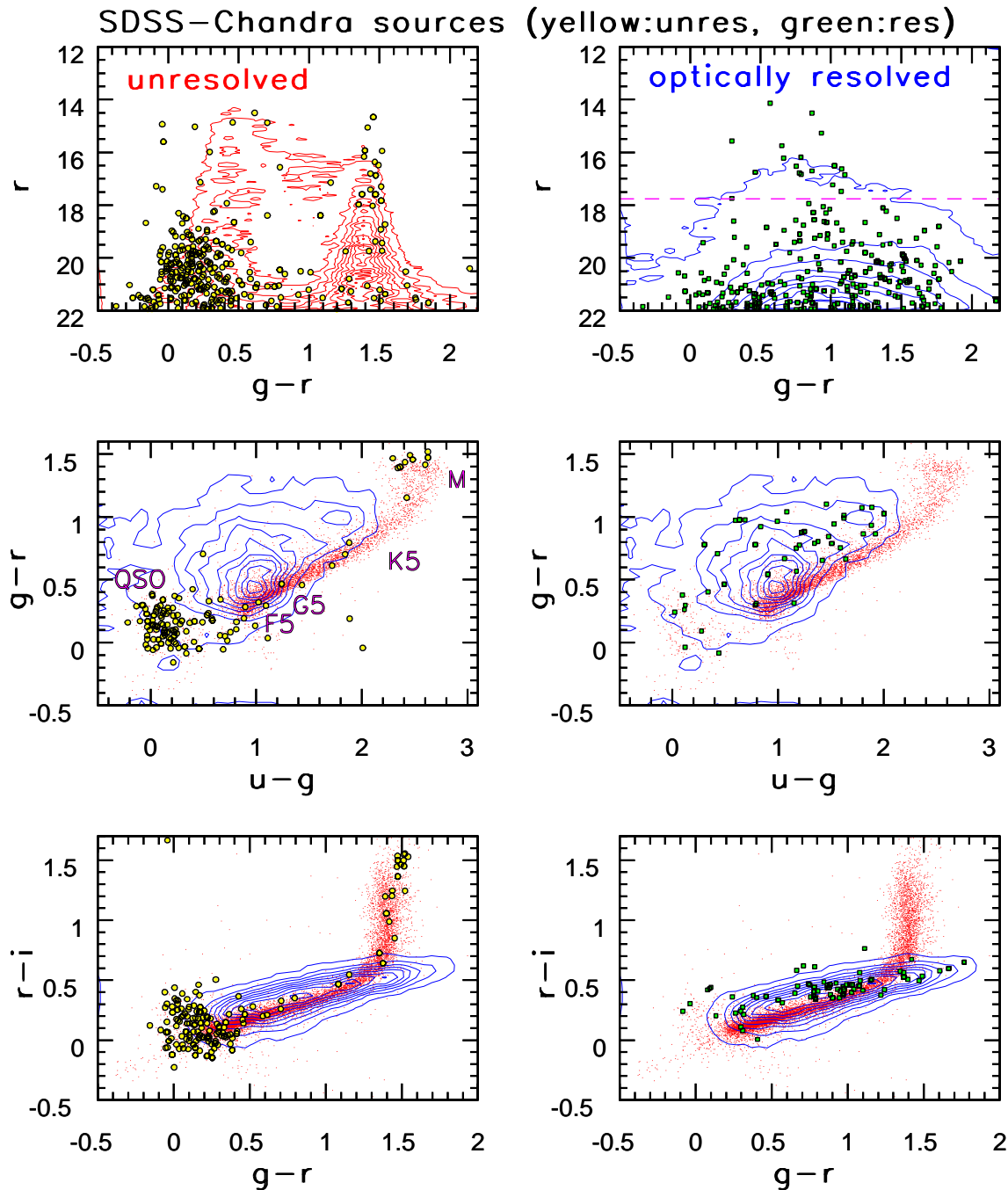

SDSS-Champ Sources

- Wavelength: soft/hard X rays (0.5-8 keV), Depth: $m_{AB} < 24$, Astrometric accuracy ~ 1 arcsec
- A small fraction of SDSS sources are detected by Chandra; mostly fainter than SDSS spectroscopic limits
- Point sources dominated by quasars; also some active (M) stars
- Galaxies are dominated by AGN hosts
- Potential: X-ray part of SED; AGN population census (especially for obscured sources), stellar activity

SDSS-GALEX Sources

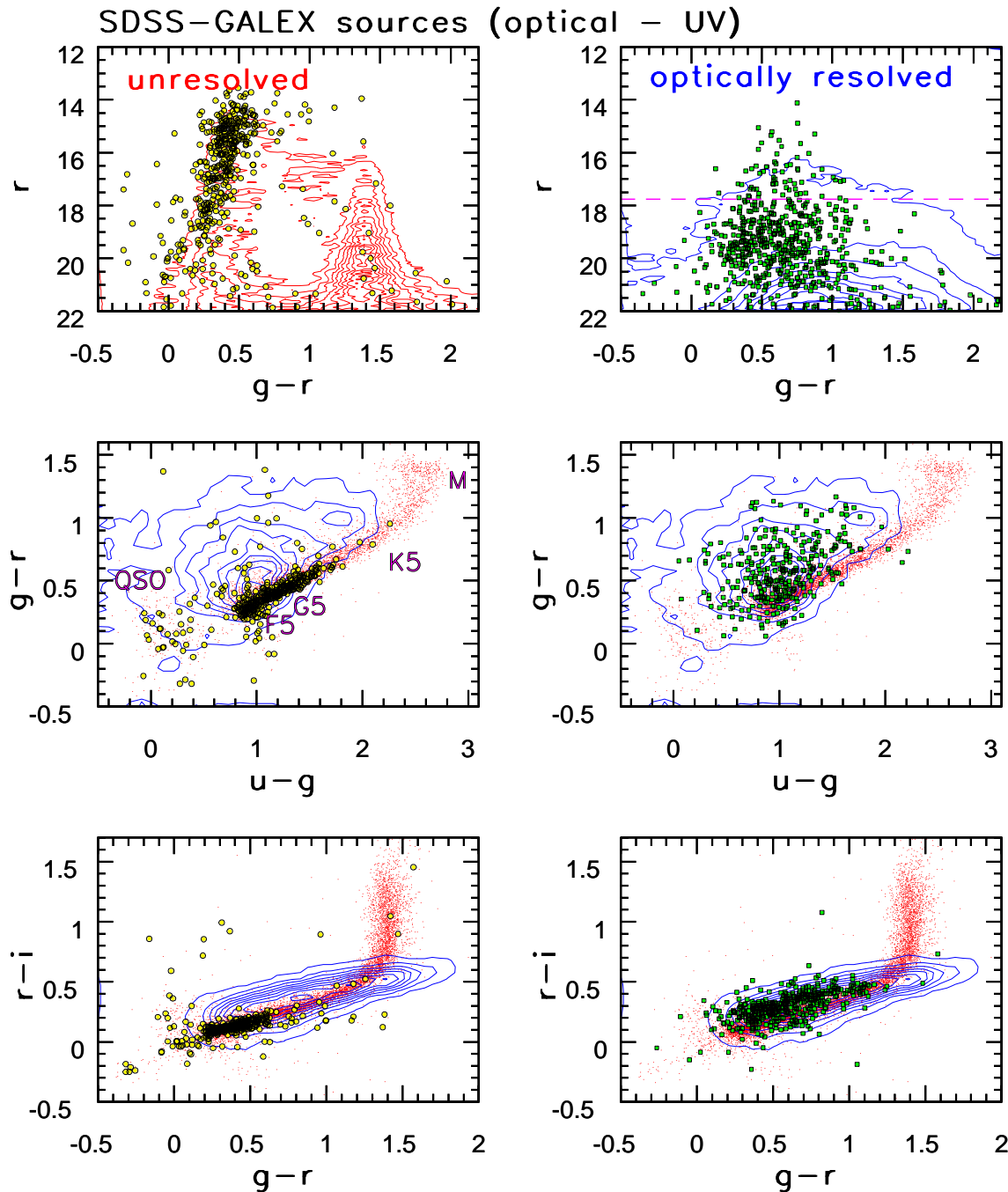

- Wavelength: UV, Depth: $m_{AB} < 21.5$, Astrometric accuracy $\sim 1 - 2$ arcsec
- A small fraction of SDSS sources are detected by GALEX; a good fraction of stars have spectra, galaxies mostly fainter than SDSS spectroscopic limit
- Point sources dominated by hot blue (turn-off) stars; also some quasars
- Galaxies dominated by blue starburst galaxies ($u - r < 2.2$) (and some AGNs)
- Potential: UV part of SED, estimates of star-formation rate and its dependence on other parameters, dust

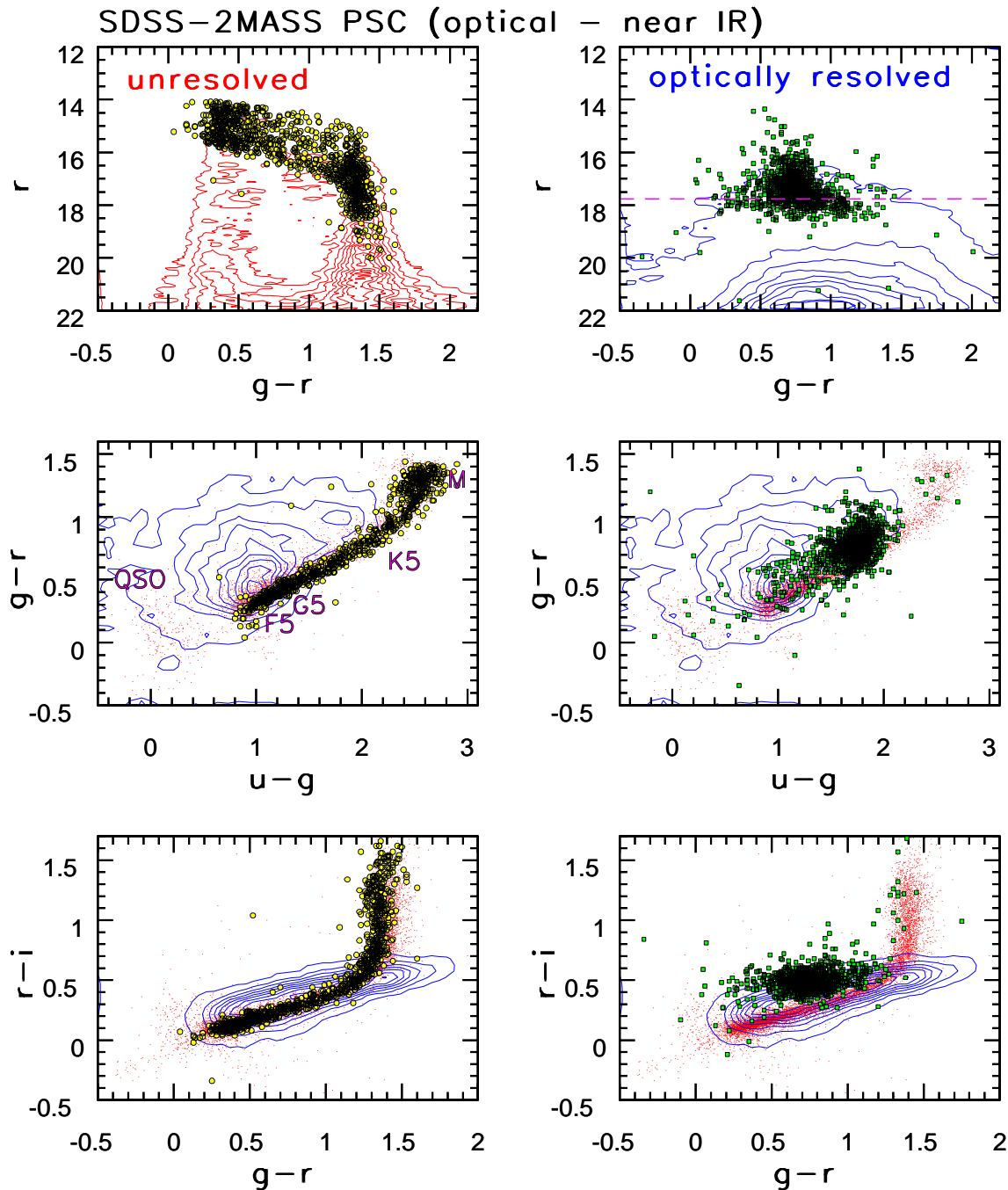

SDSS-2MASS sources

- Wavelength: near-IR (JHK), Depth: $m_{AB} < 16.1$ (K band), Astrometric accuracy < 0.15 arcsec
- 2MASS detects bright stars (blue with $r < 16$, red with $r < 18$, for 10σ flux limit in K band, $K < 14.3$)
- 2MASS detects galaxies brighter than $r \sim 18$ (roughly, SDSS “main” spectroscopic galaxy sample); about 30% resolved by 2MASS;
- Great potential for finding sources with unusual optical/IR SEDs (e.g. dusty stars, binary stars, obscured QSOs)

SDSS-FIRST sources

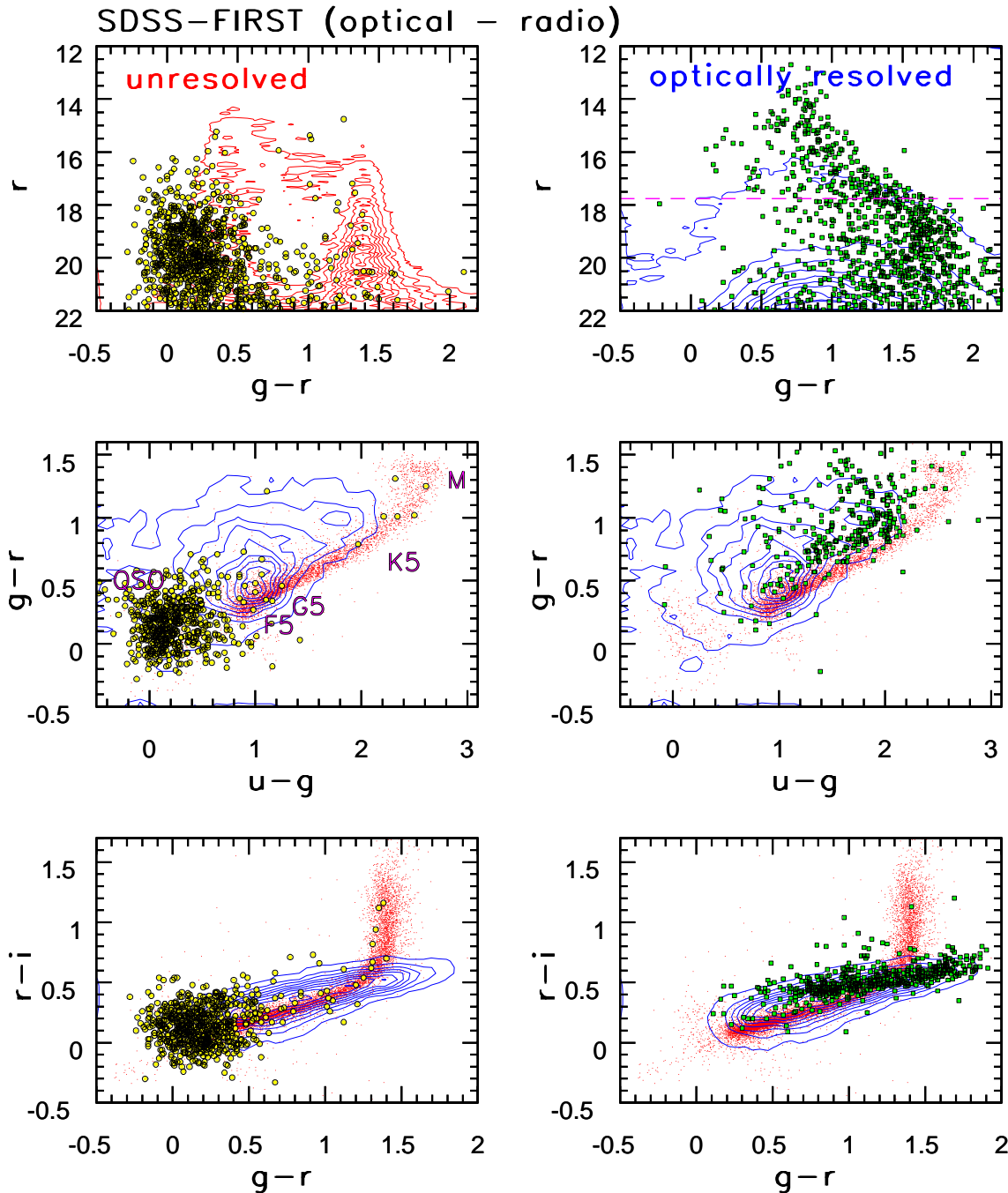

- Wavelength: radio (20 cm), Depth: $m_{AB} < 16$, Astrometric accuracy < 0.3 arcsec
- Point sources with radio emission are dominated by quasars
- Galaxies dominated by AGNs (and some star-forming)
- Radio galaxies are biased towards red luminous galaxies
- Bias towards red galaxies is a result of selection effects: elliptical galaxies with radio emission are NOT redder than typical elliptical galaxy

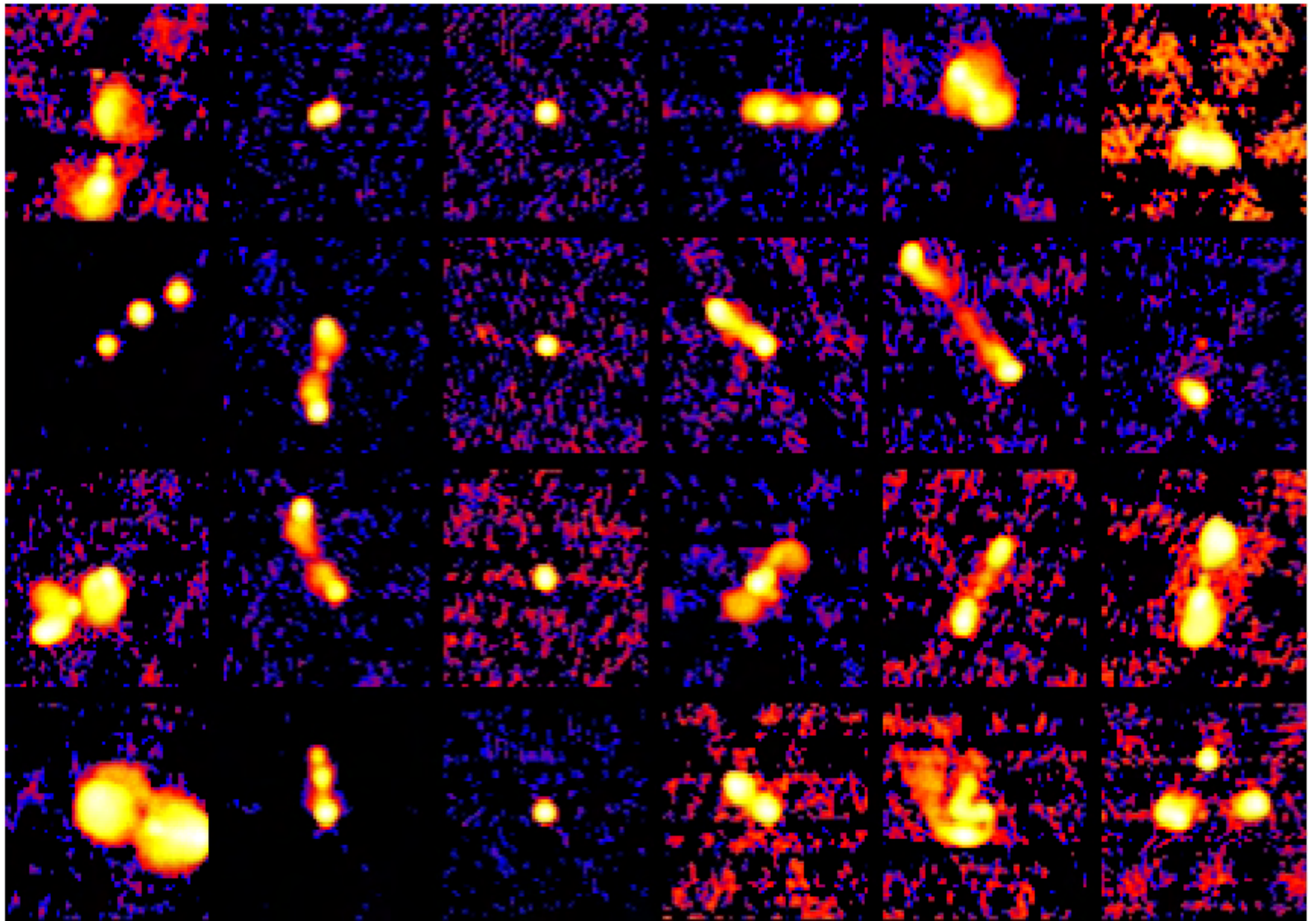

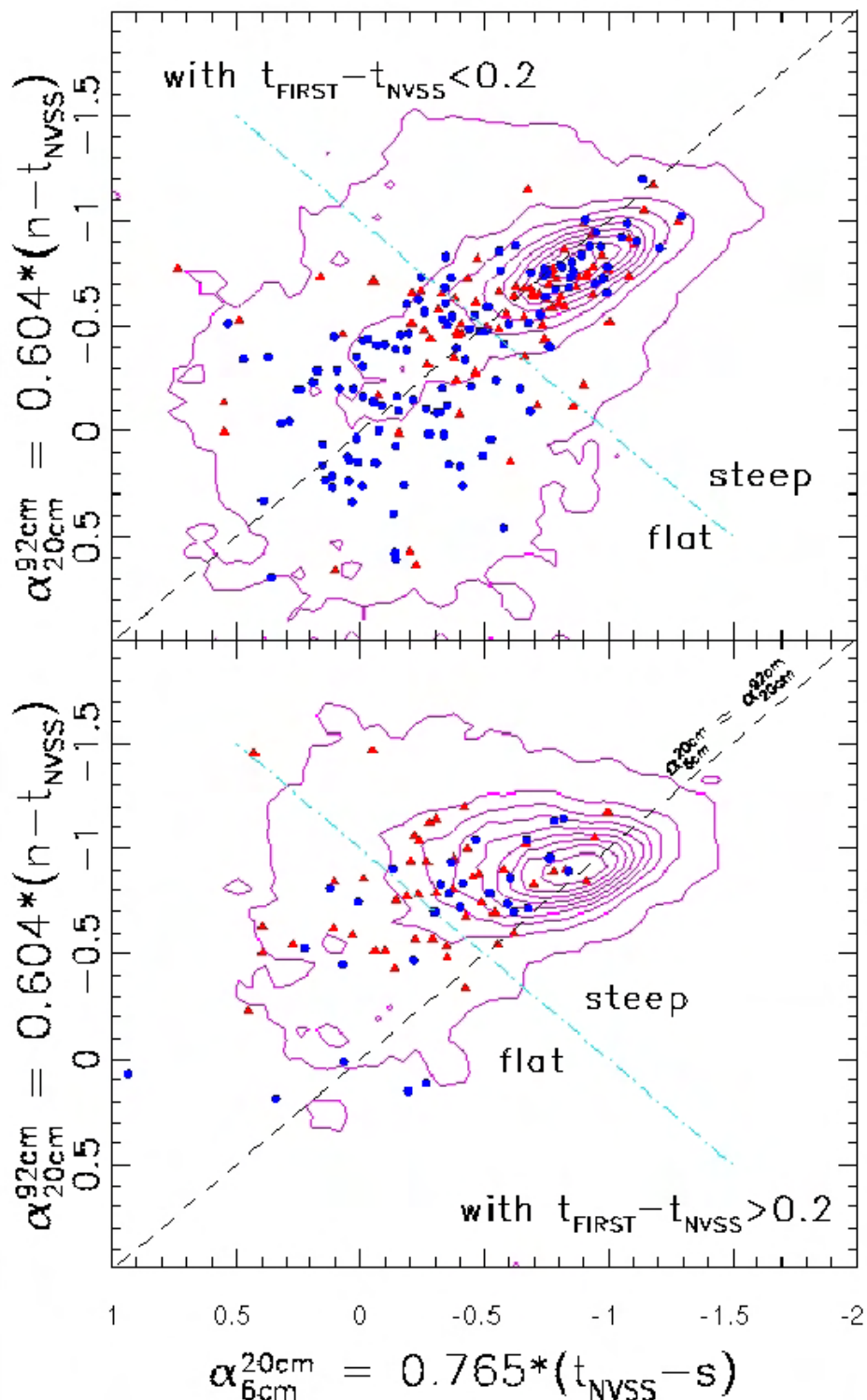

Radio “color-color” diagrams

- Five different catalogs: 4 radio catalogs for radio colors and morphology separation, and SDSS for quasar/galaxy separation (Kimball et al. 2006)
- It was not possible to produce such a diagram only a few years ago!
- The state-of-the-art models are unable to reproduce the distribution of detected sources in the radio flux–color–size space.

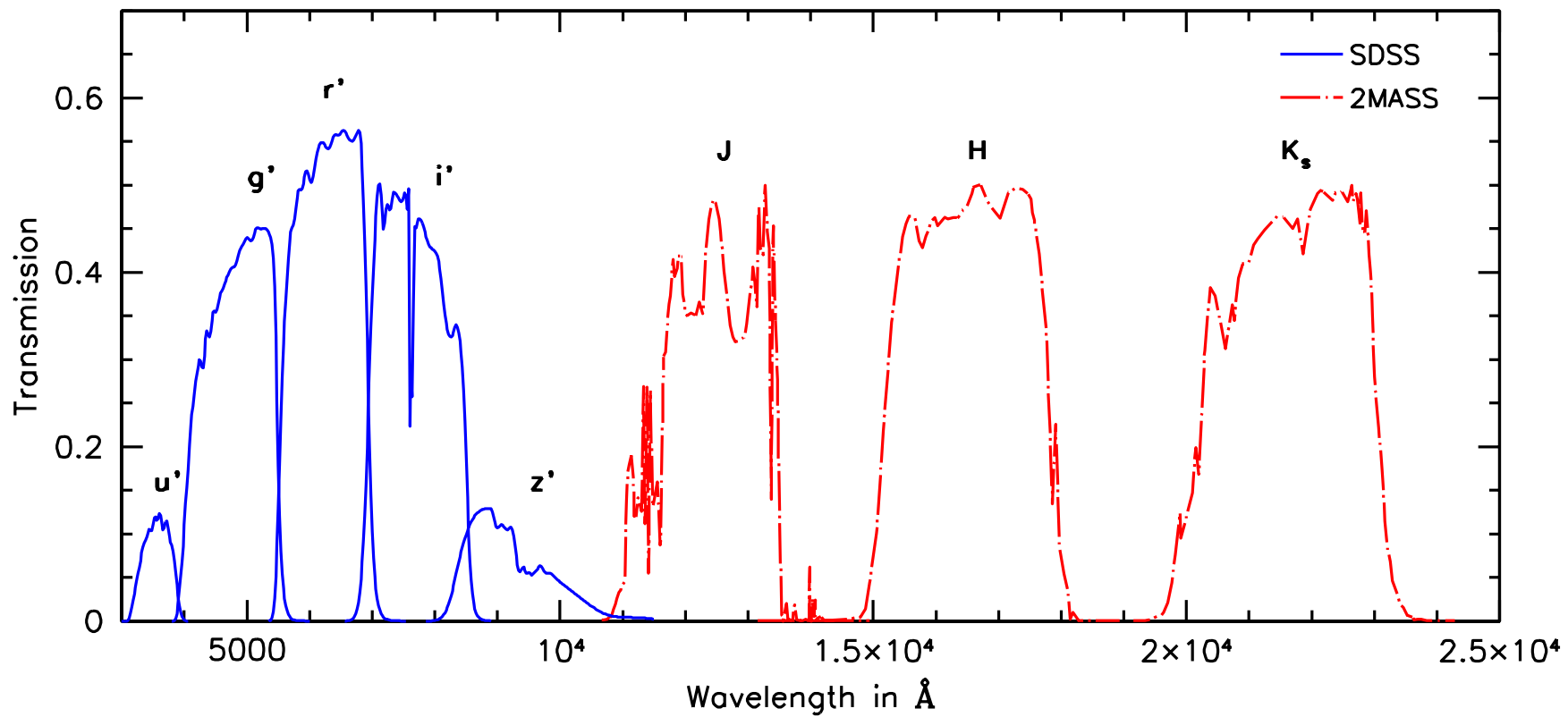

8-color Photometry

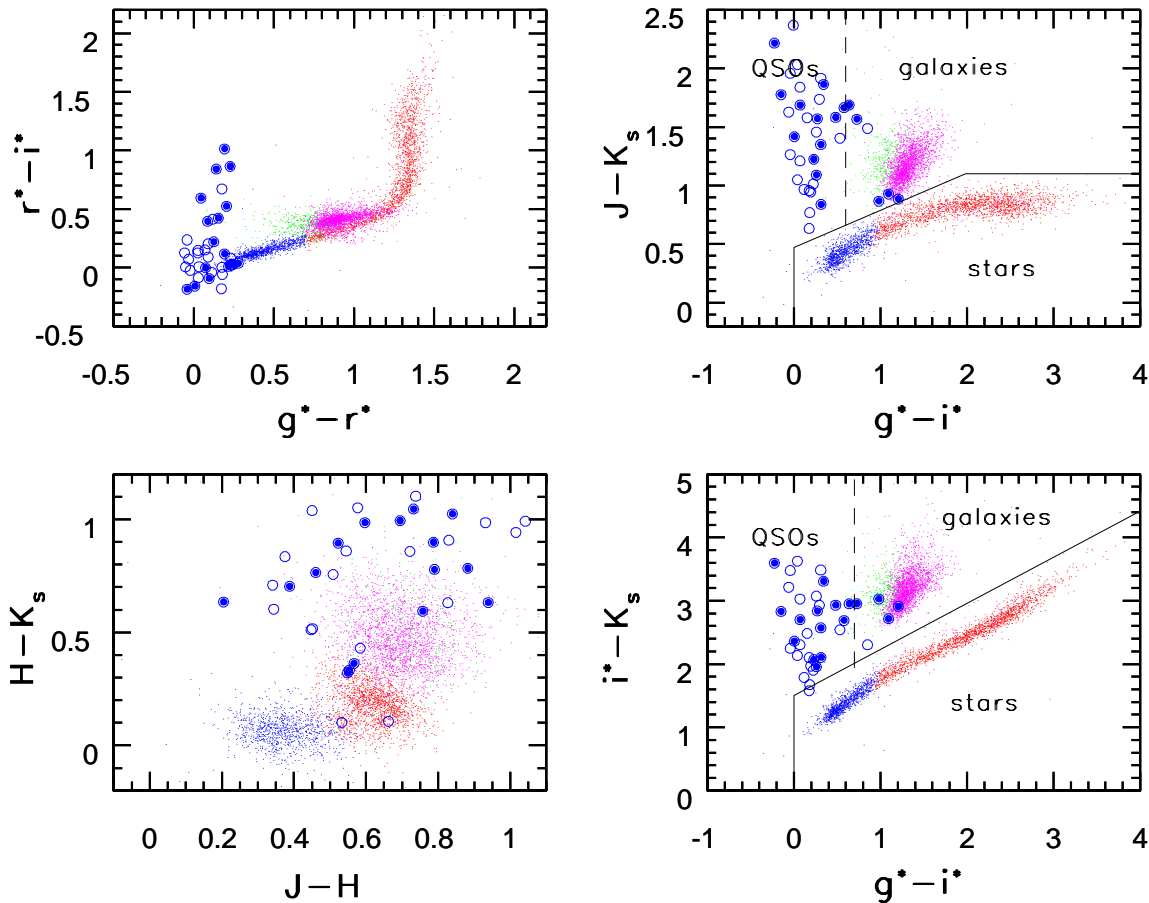

- With 8 bands, can construct 336 different color-color diagrams – 6 are fully independent 2D projections!
- Blue/red: blue and red stars; green/magenta: blue and red galaxies, Circles: quasars ($z < 2.5$)
- Optical/IR colors allow an efficient star-quasar-galaxy separation (unlike optical colors)
- 8-band accurate and robust photometry excellent for finding objects with atypical SEDs (e.g. red AGNs, L/T dwarfs, binary stars, dusty stars)

GALEX-SDSS-2MASS: galaxy SEDs

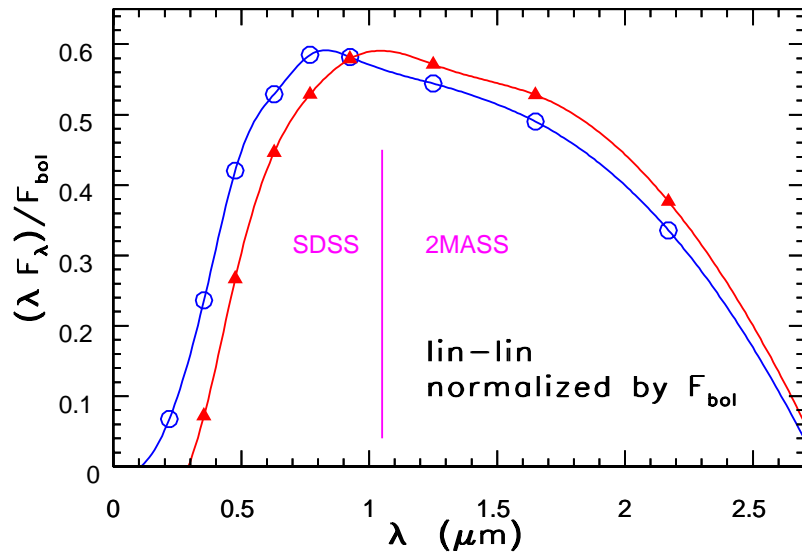
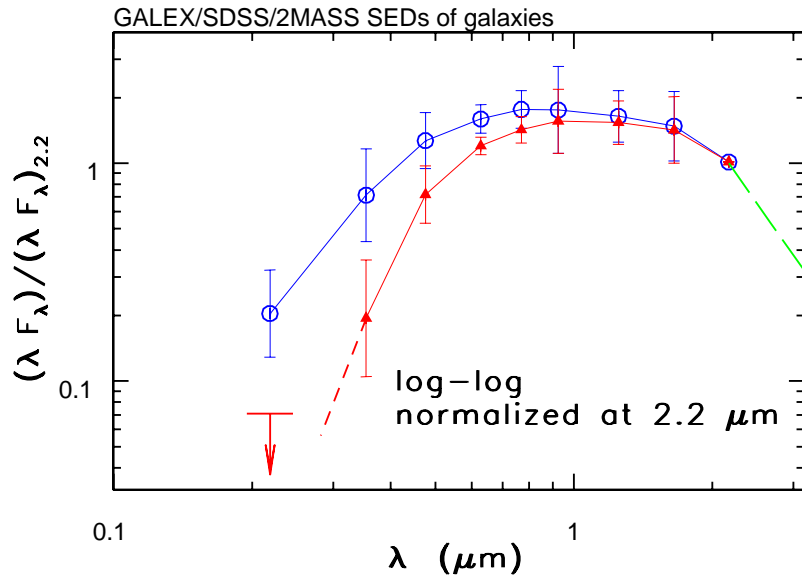

- The fact that galaxy SEDs are nearly one-parameter family at SDSS wavelengths extends to GALEX and 2MASS wavelengths
- Using SDSS u and r band fluxes, it is possible to predict 2MASS K band flux to within 0.2 mag! (astrophysical scatter only ~ 0.1 mag)
- “common wisdom”: such a relationship should *not* be so accurate due to the effects of starbursts and dust extinction (Obrić et al. 2006)

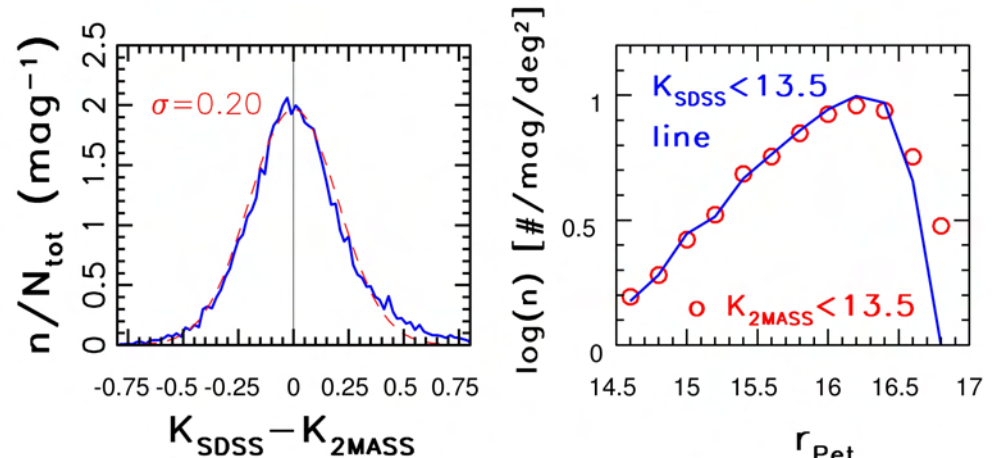

GAIA: optical astrometric survey

- Accurate positions (a few μarcsec) and spectrophotometry: distances and kinematics for about a billion stars
- Complete to $V \sim 20$, radial velocity to $V \sim 17$, 1% distances for a few million stars
- Science Drivers:
 1. star formation
 2. stellar evolution
 3. formation and evolution of the Milky Way
- A major European project with many collaborating institutions

GAIA

Stellar
Astrophysics

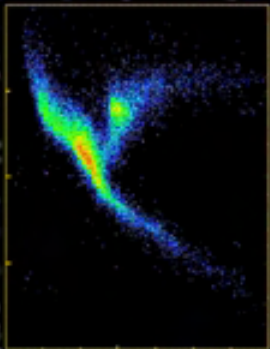

Star Formation
History of the
Milky Way

Galactic
Structure

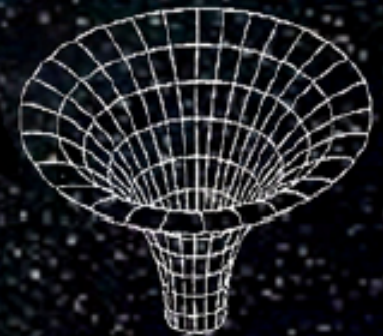

Fundamental
Physics

Binaries and
Brown Dwarfs



Extrasolar
Planets

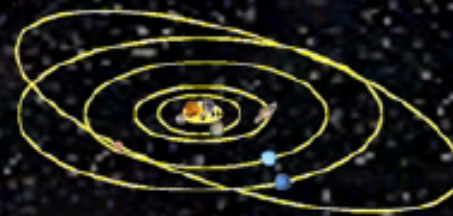

Solar
System

Reference
Frame

AKARI: mid-IR survey

- Launched in 2006 (0.7m telescope), a successor to IRAS
- **An all-sky survey** in 4 bands (50–200 μm) with a sensitivity one to two orders of magnitude better ($m_{\text{AB}} \sim 13$ for $\lambda < 100 \mu\text{m}$) and resolution a few times higher (30 arcsec) than IRAS



Far-infrared Image of Reflection Nebula IC4954 (wavelength : 90 micrometers)

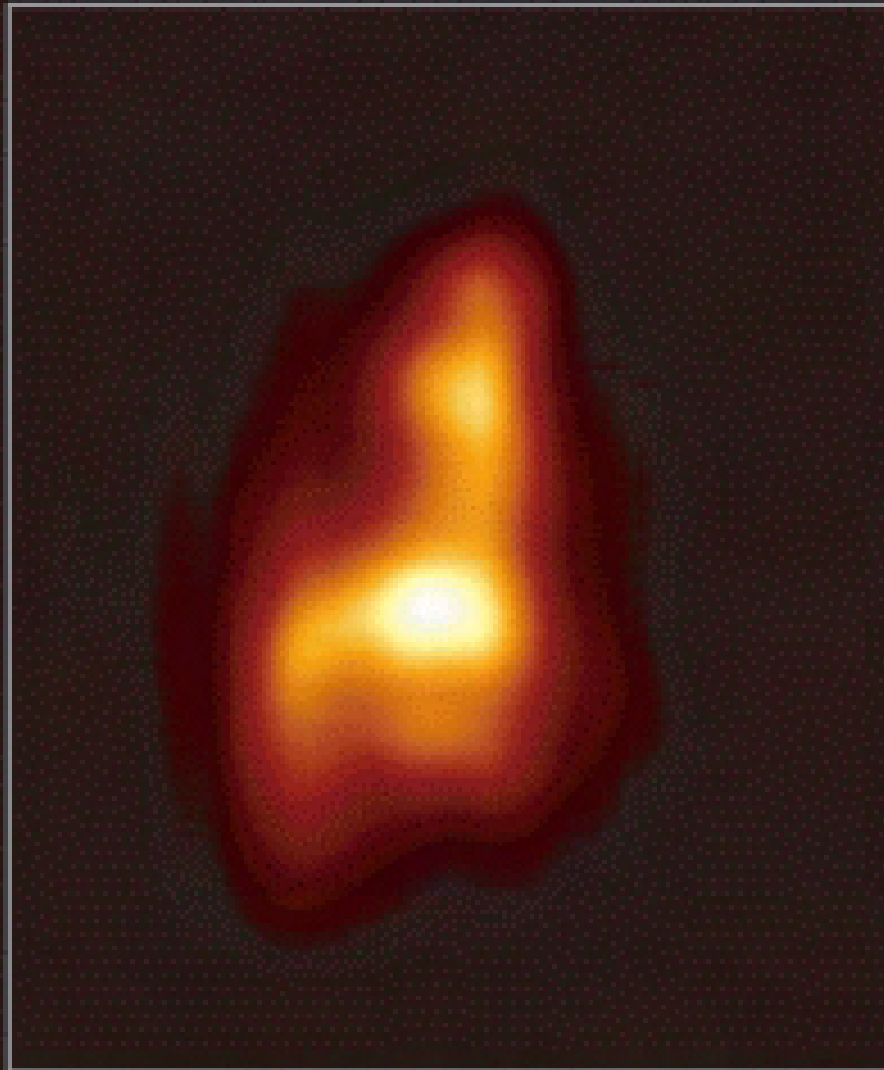

AKARI / Far Infrared Surveyor

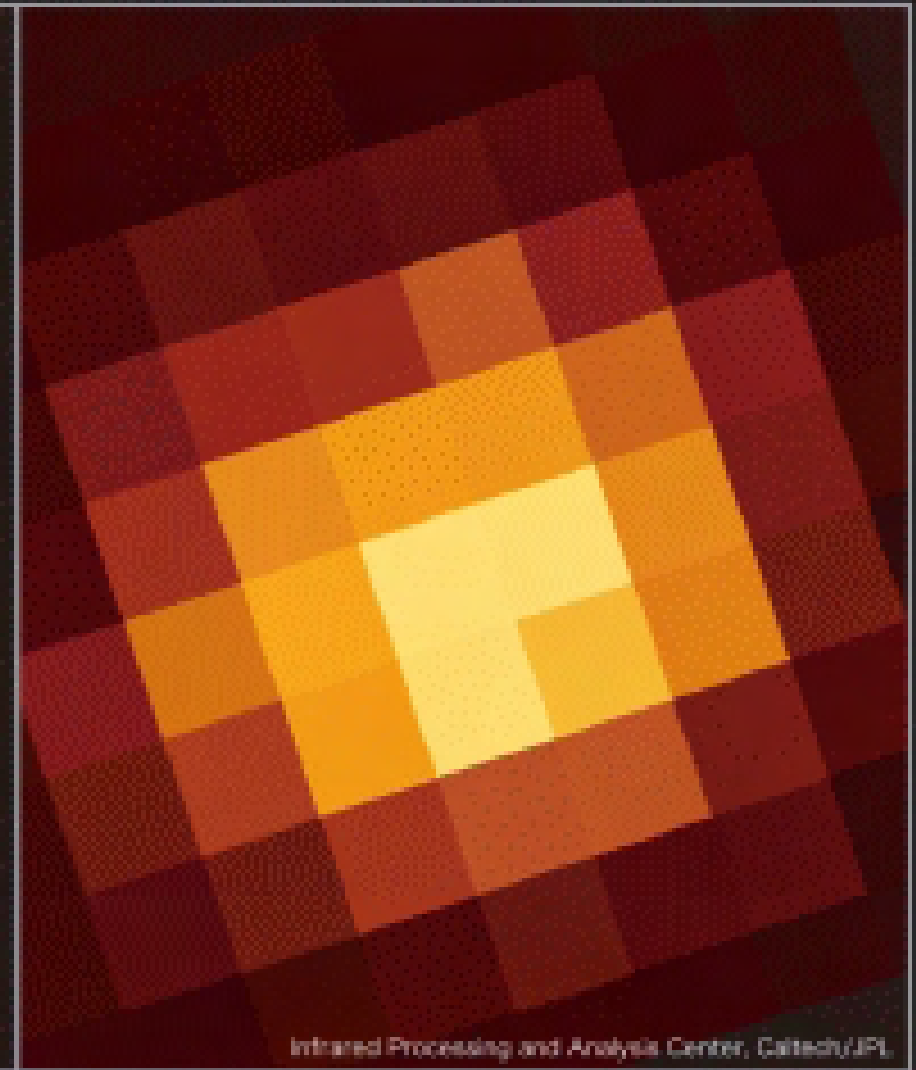

IRAS image

Infrared Processing and Analysis Center, Caltech/JPL



22nd May, 2006



Mid-infrared Image of Reflection Nebula IC4954 (wavelength : 9 micrometers)

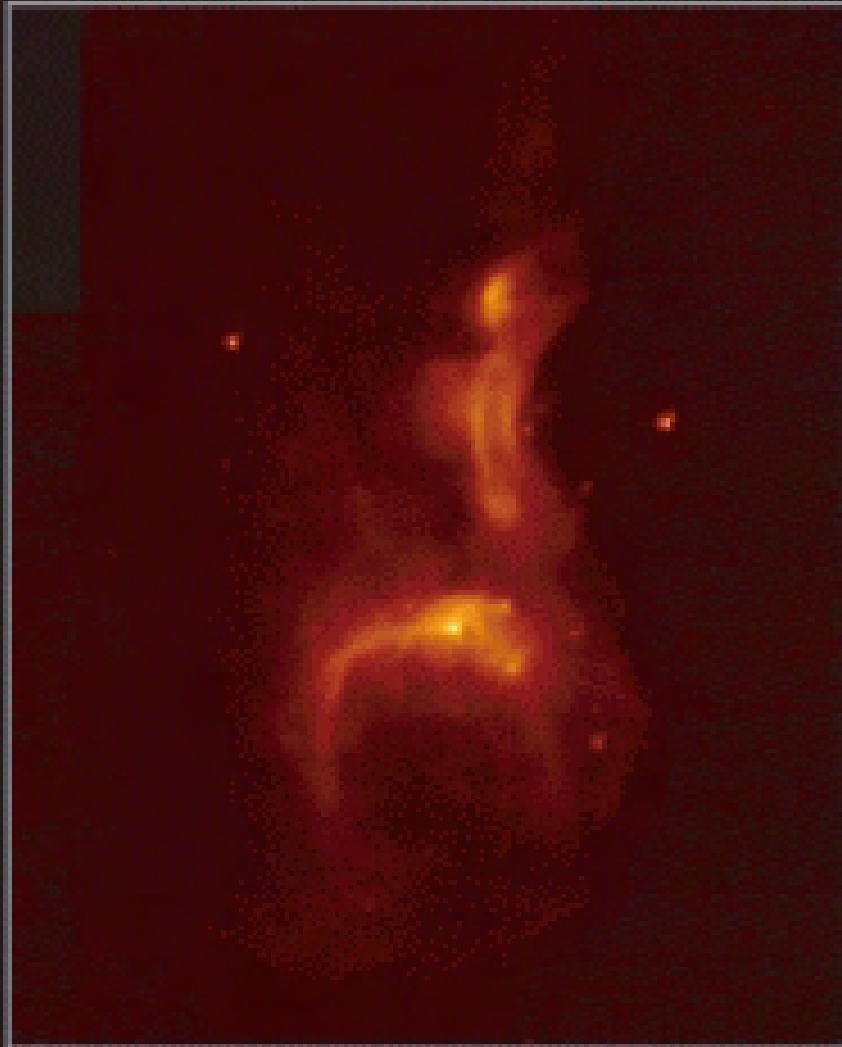

AKARI / Infrared Camera

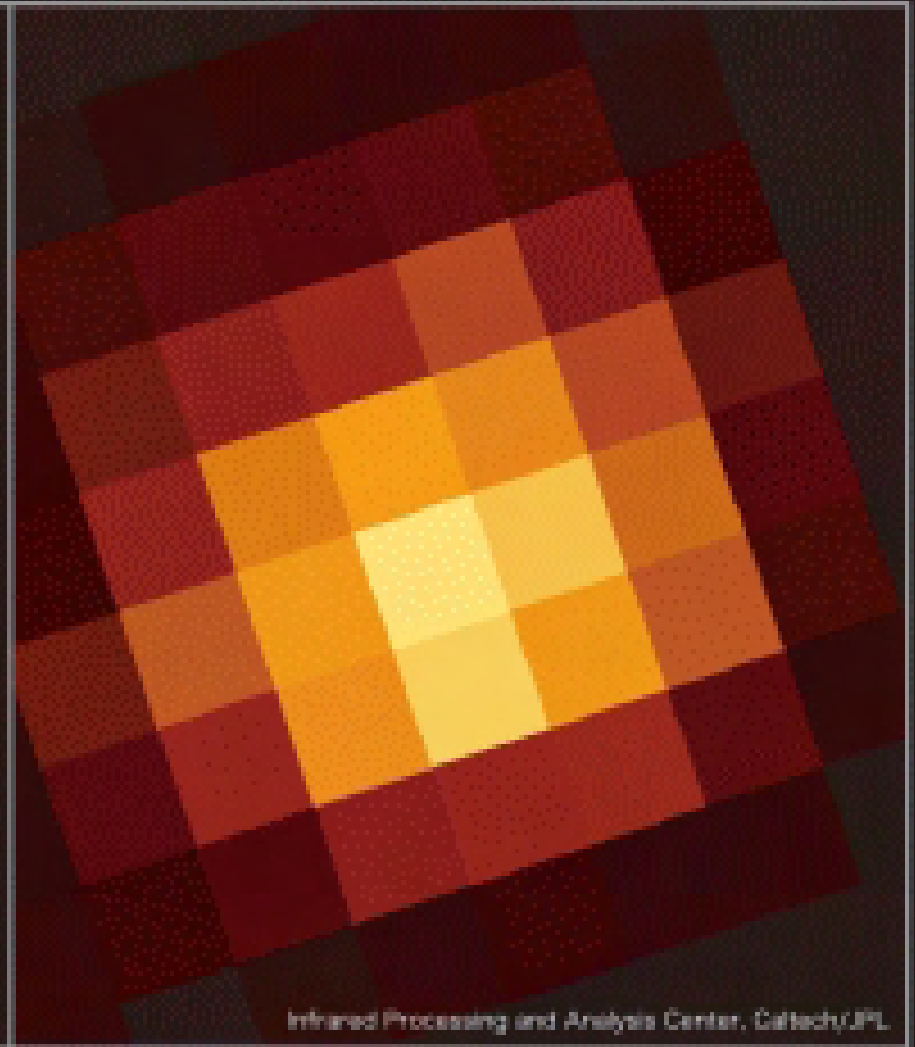

IRAS image

Infrared Processing and Analysis Center, Caltech/JPL



22nd May, 2006

AKARI: mid-IR survey

- Launched in 2006 (0.7m telescope), a successor to IRAS
- **An all-sky survey** in 4 bands (50–200 μm) with a sensitivity one to two orders of magnitude better ($m_{\text{AB}} \sim 13$ for $\lambda < 100 \mu\text{m}$) and resolution a few times higher (30 arcsec) than IRAS
- Pointed observations (deep imaging and low-resolution spectroscopy from 1.8 to 26 μm)
- **Science Drivers:**
 1. galaxy formation and evolution
 2. formation process of stars and planetary systems

The Era of Massive Optical Surveys

The Era of Massive Optical Surveys

- Super-Macho, SDSS, QUEST, CFHT, DES, Pan-STARRS, LSST, and many others, in no particular order: **fast progress!**
- All these surveys want to explore some part of **the depth-color-cadence-area** parameter space (with varying measurement accuracy and image quality) **Aiming for both depth and area:**

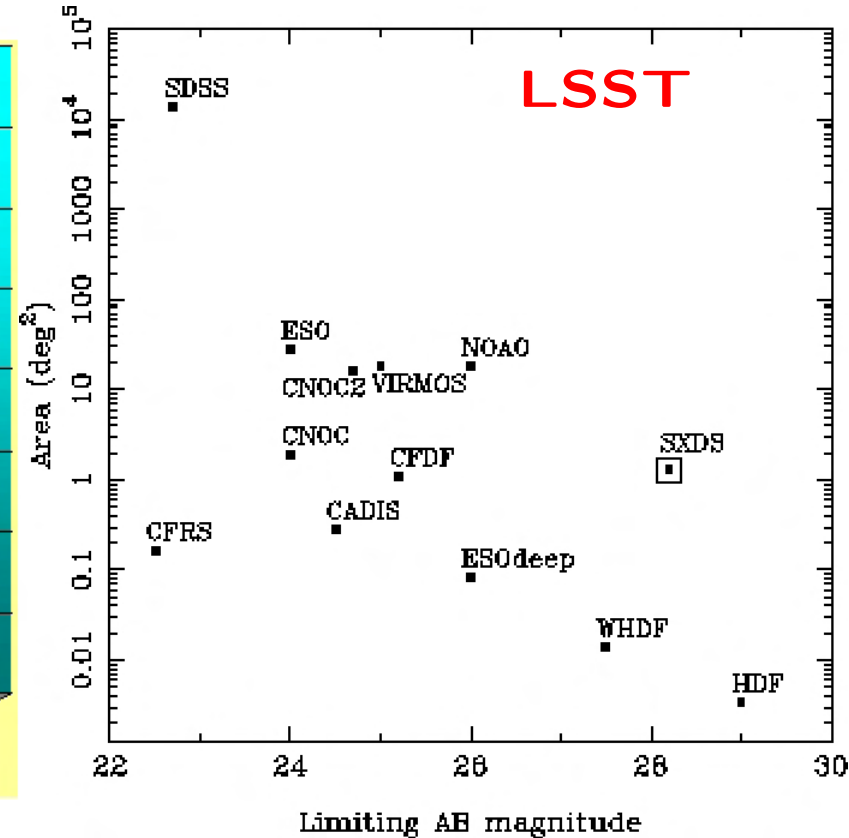
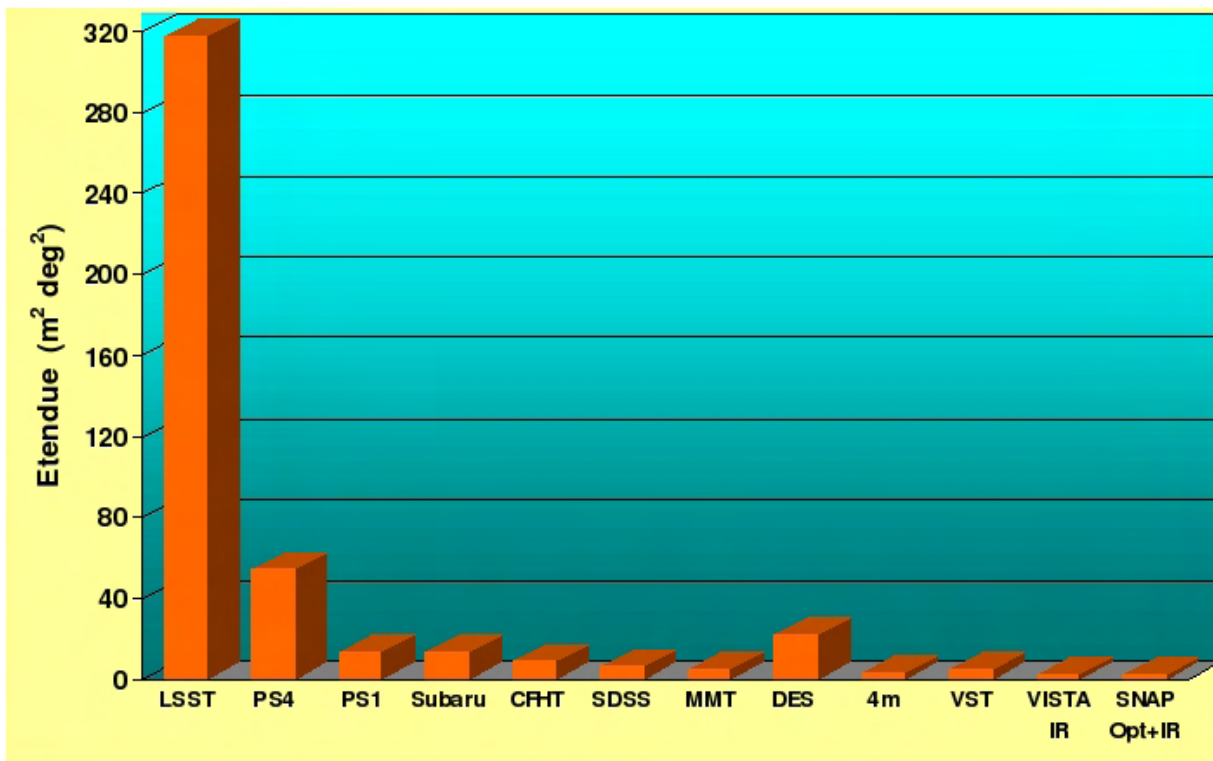

The Era of Massive Optical Surveys

- Currently, the best large-area optical survey is SDSS:
the first digital color map of the sky
- Among proposed optical surveys for the next decade or so, the two “best” ones are Pan-STARRS (PS4) and LSST (also SkyMapper and DES)
- PS4: about 10 times more surveying power than SDSS
- **LSST: about 10 times more surveying power than PS4**
- PS4: first light in 2011 (?), LSST in 2015 (?)

What will LSST do?

the first digital color movie of the sky

LSST Science Drivers

1. The Fate of the Universe: Dark Energy and Matter
2. Taking an Inventory of the Solar System
3. Exploring the Unknown: Time Domain
4. Deciphering the Past: mapping the Milky Way

Different science drivers lead to similar system requirements (NEOs, main-sequence stars to 100 kpc, weak lensing, SNe,...):

Main LSST Characteristics:

- 8.4m aperture (6.5m effective), $\sim 10 \text{ deg}^2$ FOV
- 3.2 Gigapix camera (20 TB, or one SDSS, per night)
- Sited at Cerro Pachon, Chile
- First light in 2015
- Construction cost: 400 M\$ (public-private partnership)

And also to the same observing strategy (cadence): a homogeneous dataset will utilize 90% of observing time and serve the majority of science programs (with a high system efficiency)

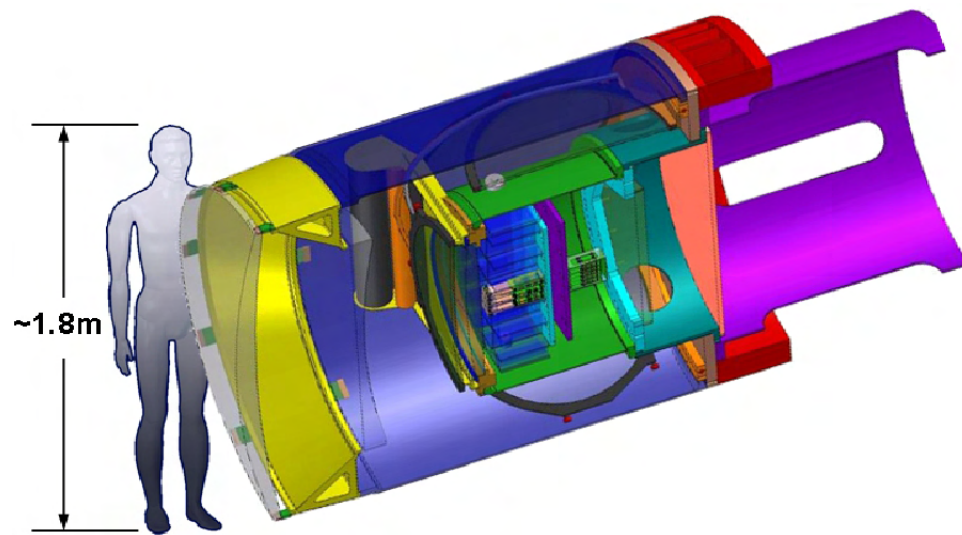
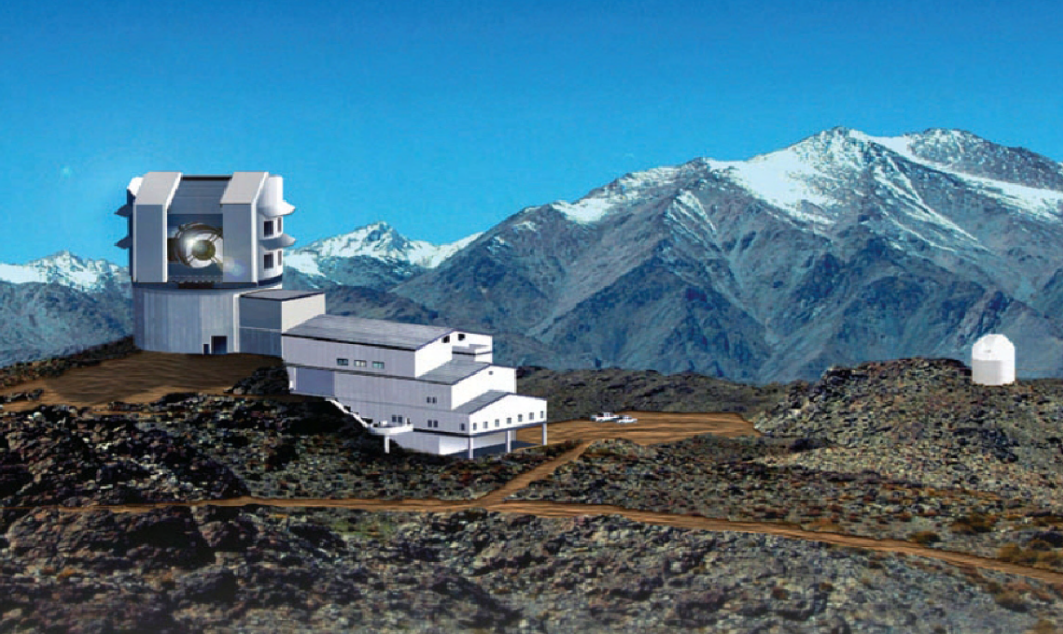

Wavefront Sensors
(4 locations)

Guide Sensors
(8 locations)

3.5 degree Field
of View (634 mm diameter)

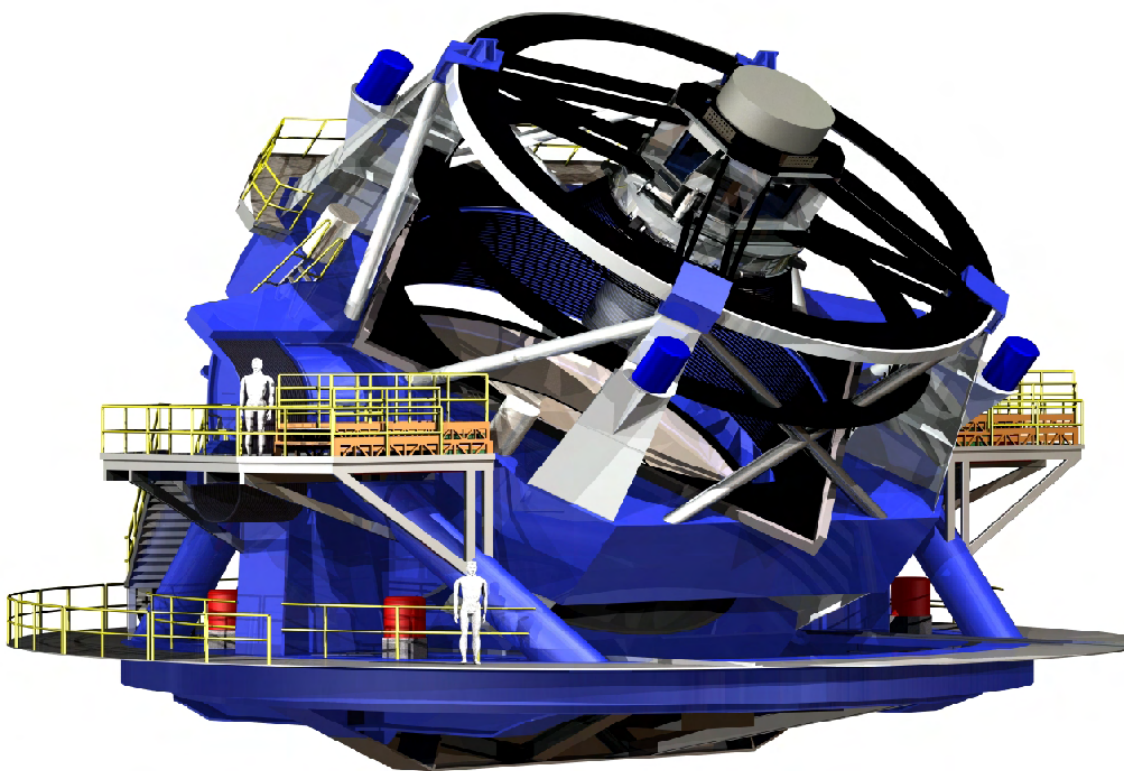
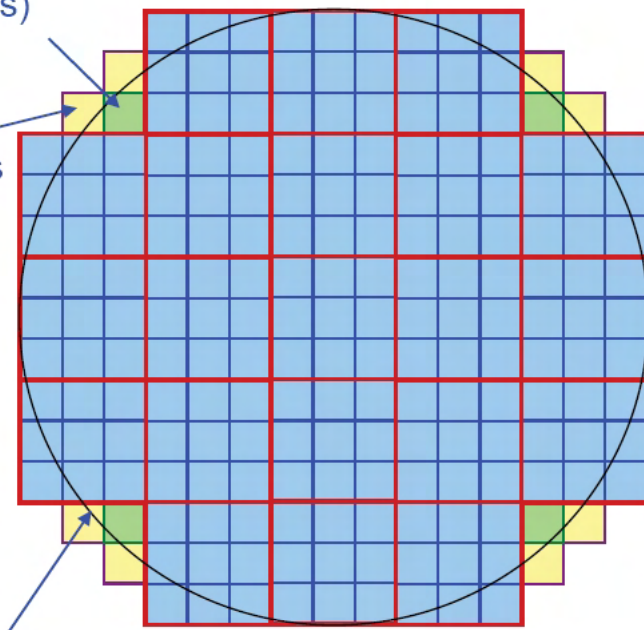

Primary Mirror Diameter

Field of View

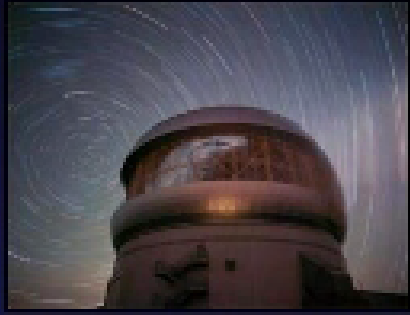

Gemini South Telescope



LSST

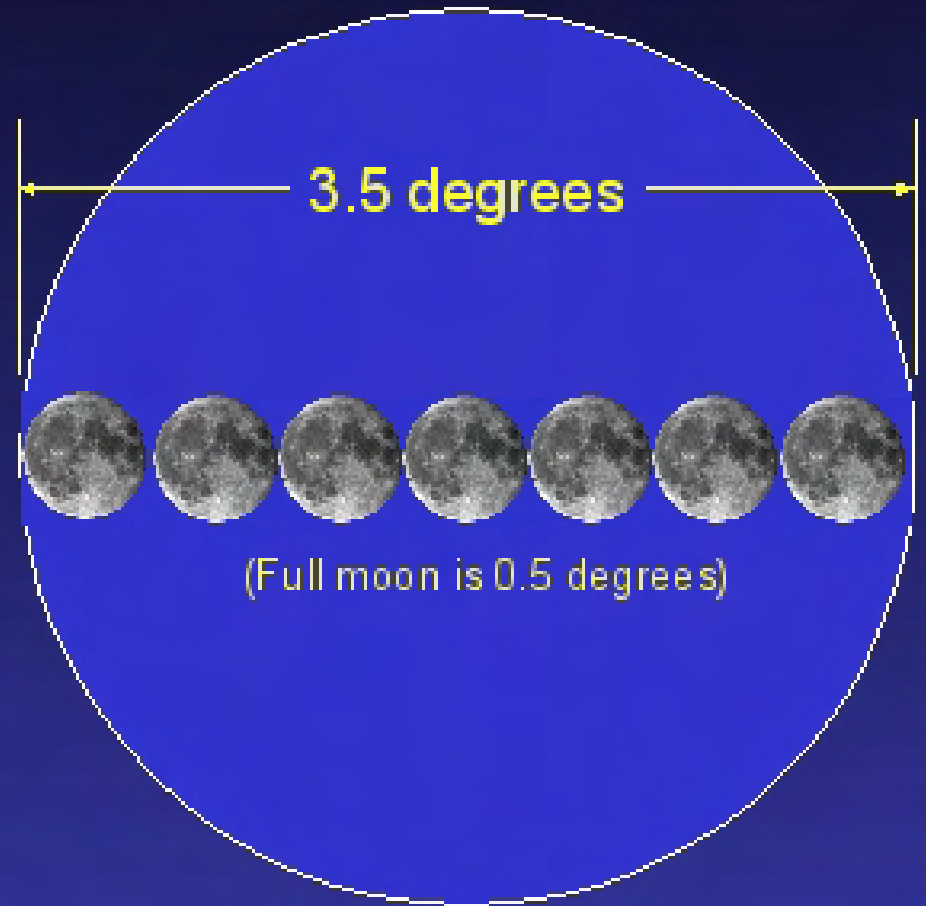
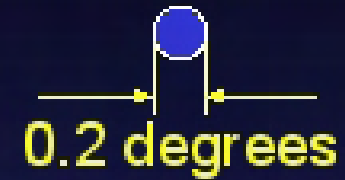

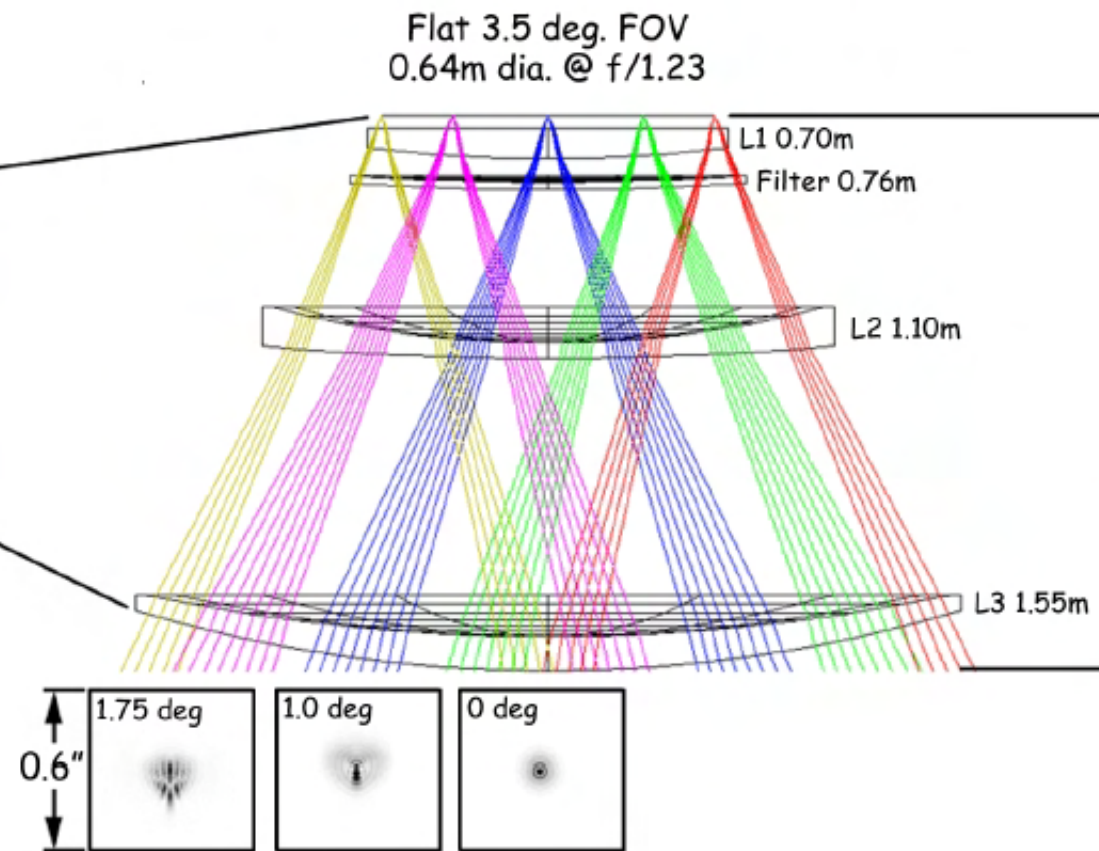
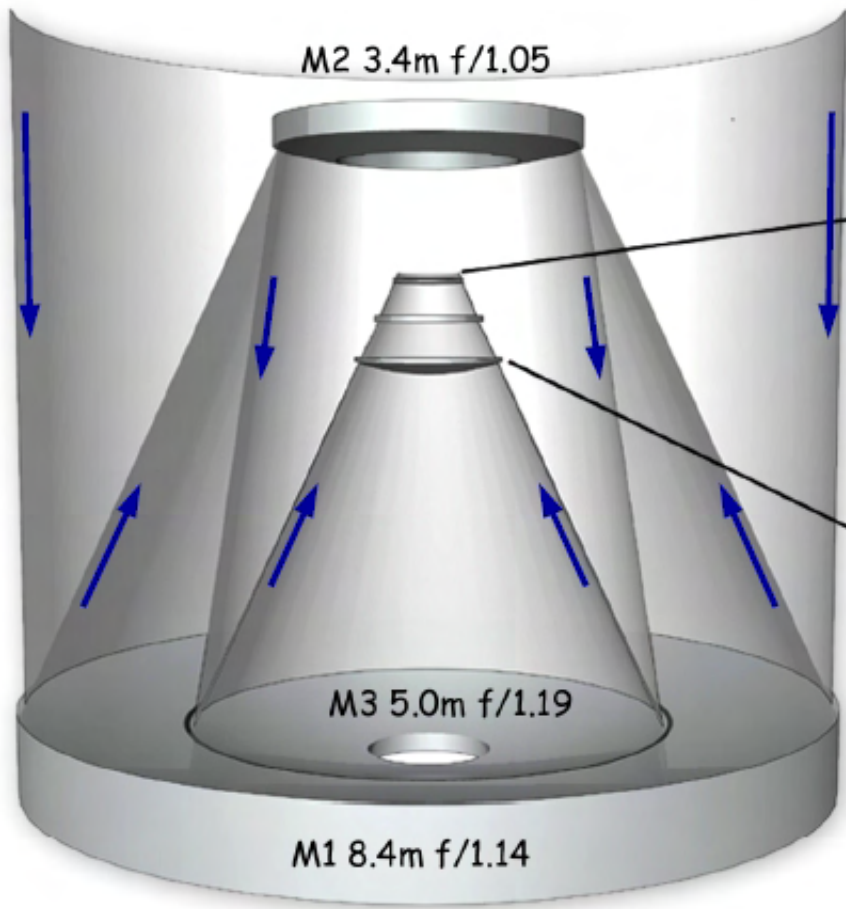

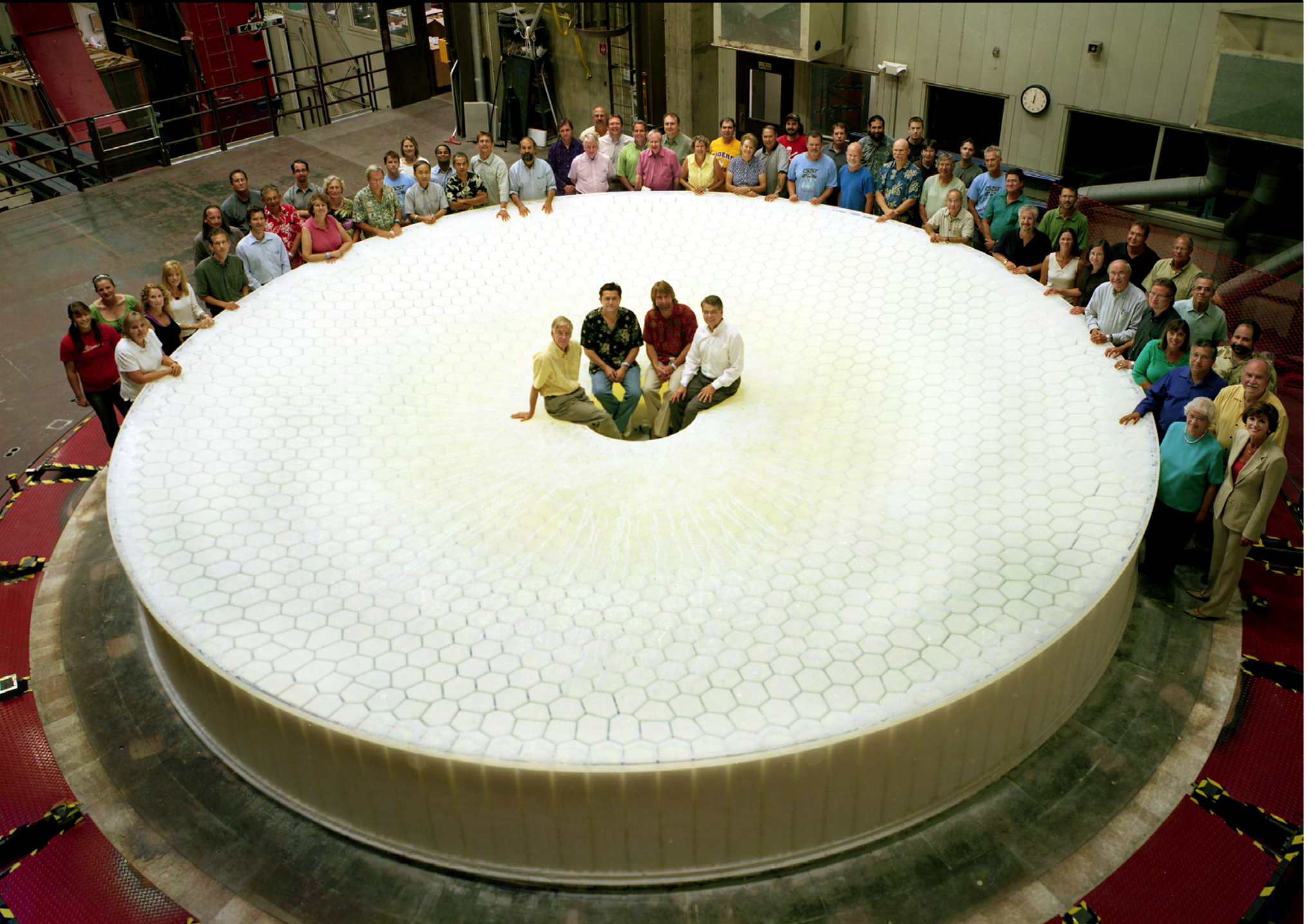

LSST Primary/Tertiary Mirror Blank

August 11, 2008, Steward Observatory Mirror Lab, Tucson, Arizona

LSST vs. SDSS comparison

Currently, the best large-area faint optical survey is

SDSS: the first digital map of the sky

$r \sim 22.5$, 1-2 visits, 300 million objects

- **LSST = d(SDSS)/dt**: an 8.4m telescope with 2x15 sec visits to $r \sim 24.5$ over a 9.6 deg² FOV: the whole (observable) sky in two bands every three nights, **1000 visits over 10 years**
- **LSST = Super-SDSS**: an optical/near-IR survey of the observable sky in multiple bands (ugrizy) to $r > 27.5$ (coadded); a catalog of **~ 10 billion stars and ~ 10 billion galaxies**

LSST: a digital movie of the sky

LSST vs. SDSS comparison

Currently, the best large-area faint optical survey is

SDSS: the first digital map of the sky

$r \sim 22.5$, 1-2 visits, 300 million objects

- **LSST = d(SDSS)/dt**: an 8.4m telescope with 2x15 sec visits to $r \sim 24.5$ over a 9.6 deg² FOV: the whole (observable) sky in two bands every three nights, **1000 visits over 10 years**
- **LSST = Super-SDSS**: an optical/near-IR survey of the observable sky in multiple bands (ugrizy) to $r > 27.5$ (coadded); a catalog of **~ 10 billion stars and ~ 10 billion galaxies**

LSST: a digital movie of the sky

LSST data will immediately become public

(transients within 30 sec)

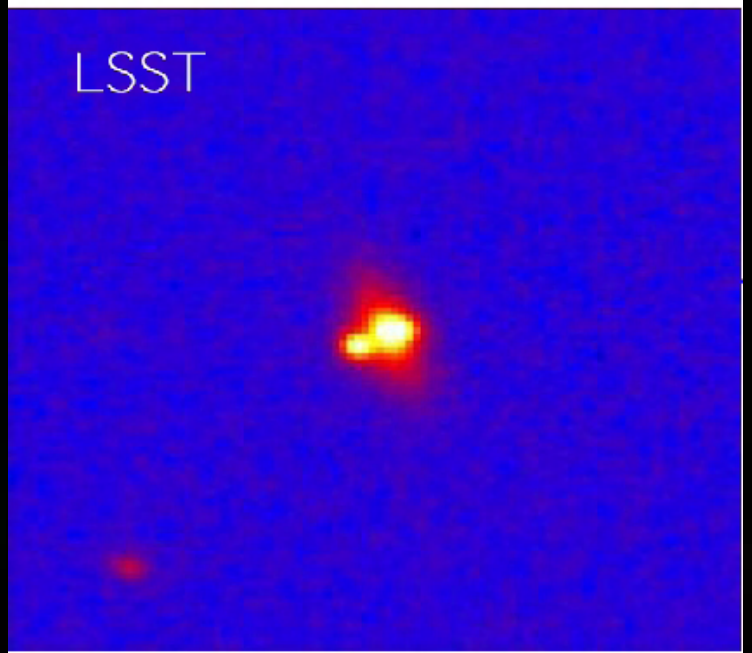
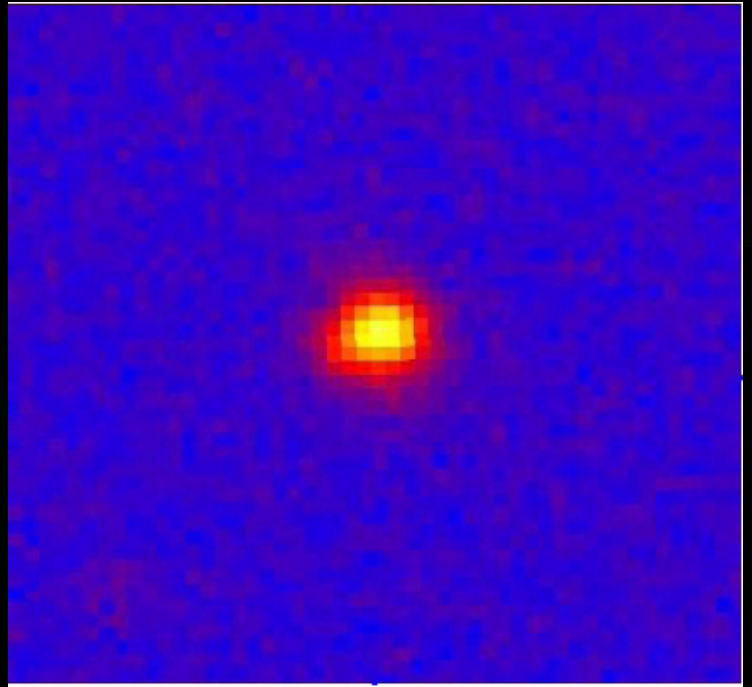

SDSS

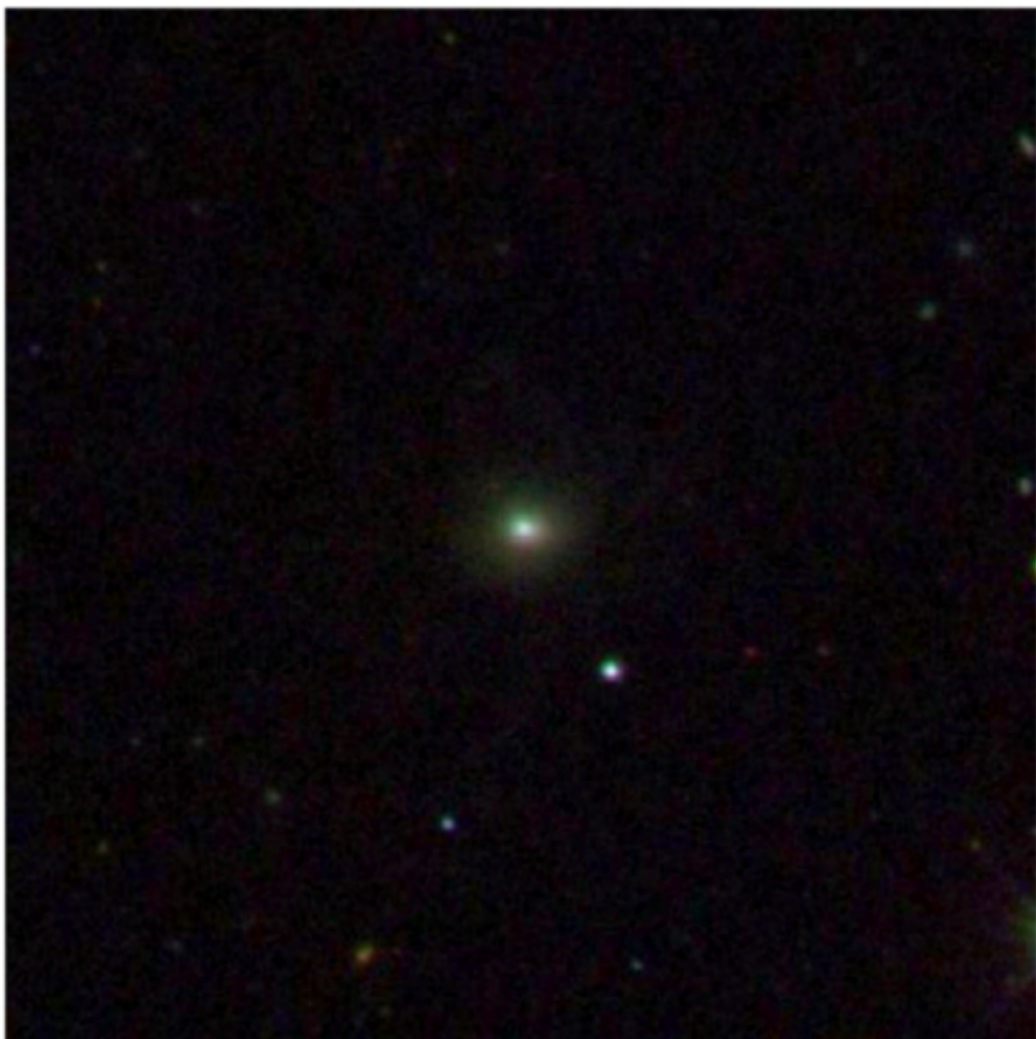

MUSYC

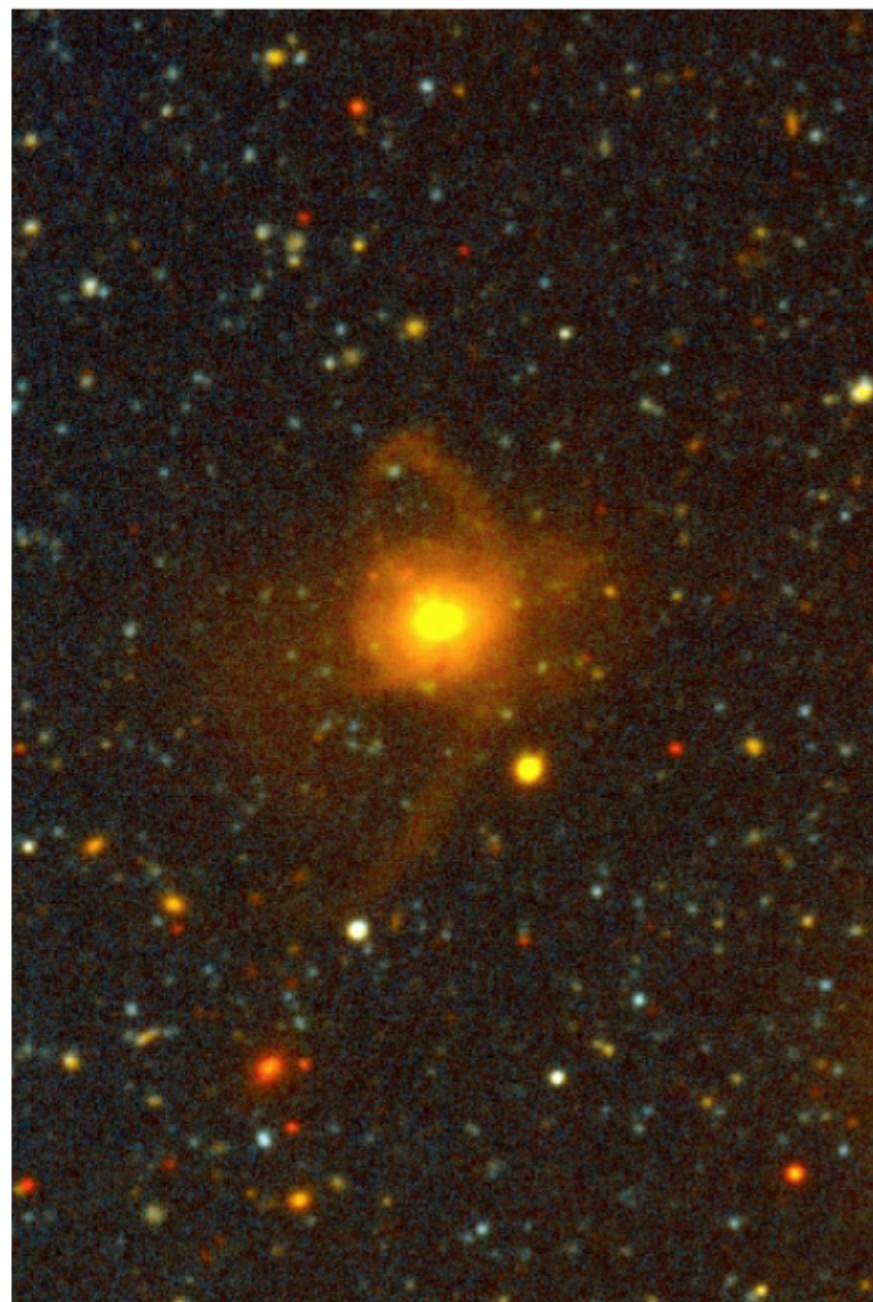

An SDSS image of the Cygnus region

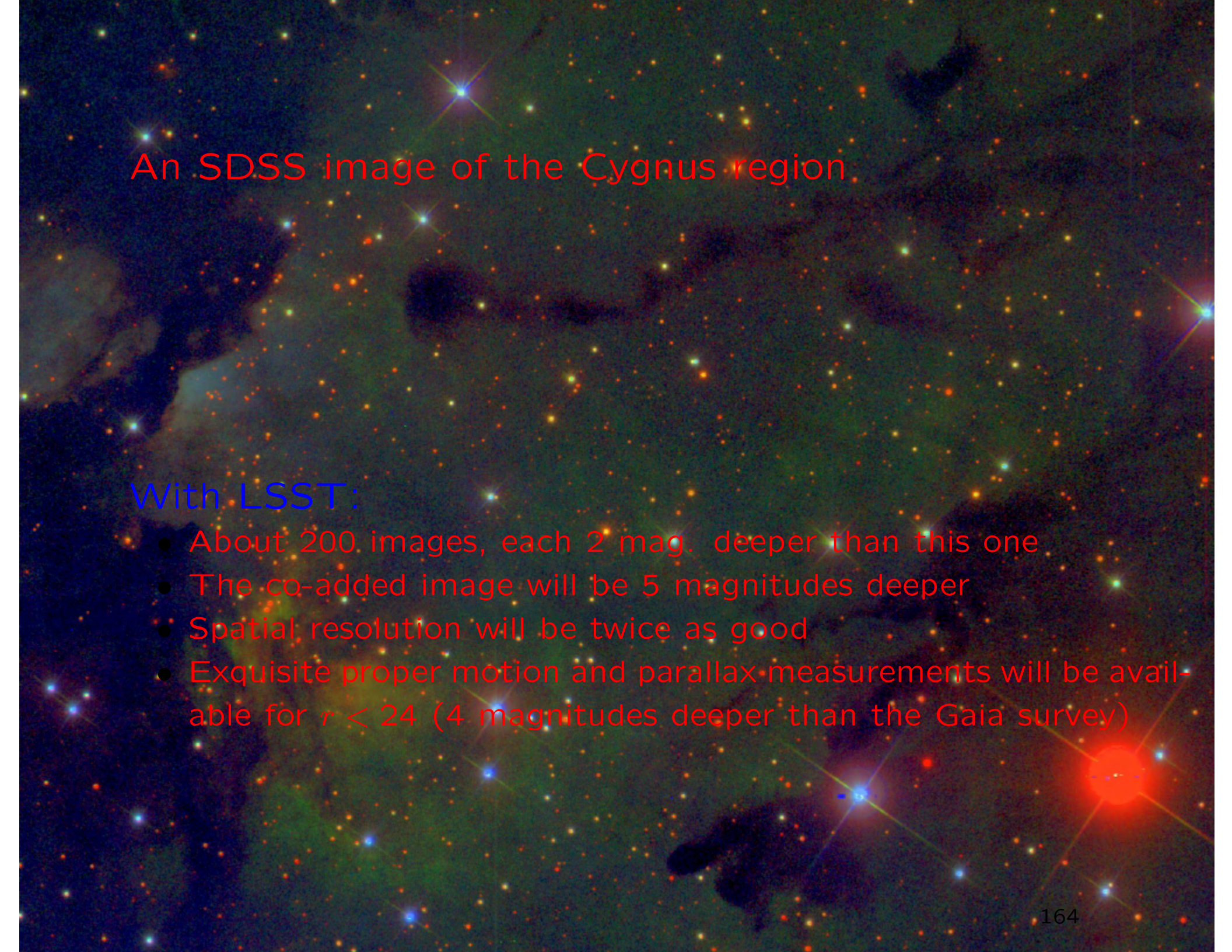

An SDSS image of the Cygnus region, showing a dense field of stars in various colors (red, yellow, green, blue) against a dark background. The stars are scattered across the frame, with some prominent bright stars and a few fainter ones. The overall appearance is that of a rich stellar population.

An SDSS image of the Cygnus region

With LSST:

- About 200 images, each 2 mag. deeper than this one
- The co-added image will be 5 magnitudes deeper
- Spatial resolution will be twice as good
- Exquisite proper motion and parallax measurements will be available for $r < 24$ (4 magnitudes deeper than the Gaia survey)

LSST Science Drivers

- The Fate of the Universe (Dark Energy and Matter): use a variety of probes and techniques in synergy to fundamentally test our cosmological assumptions and gravity theories:
 1. **Weak Lensing:** growth of structure
 2. **Galaxy Clusters:** growth of structure
 3. **Baryon Acoustic Oscillations:** standard ruler
 4. **Supernovae:** standard candle

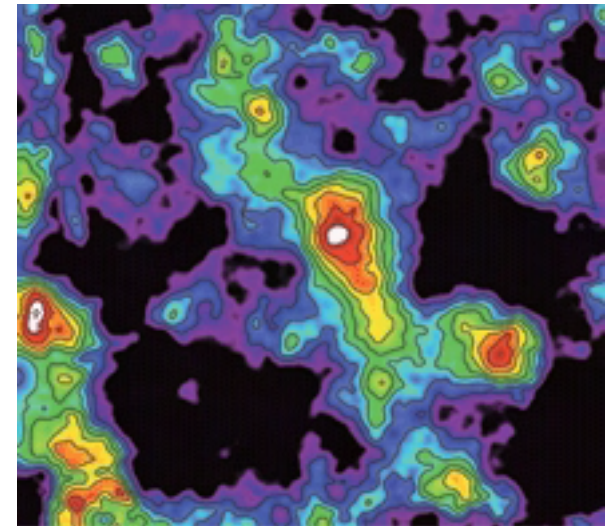
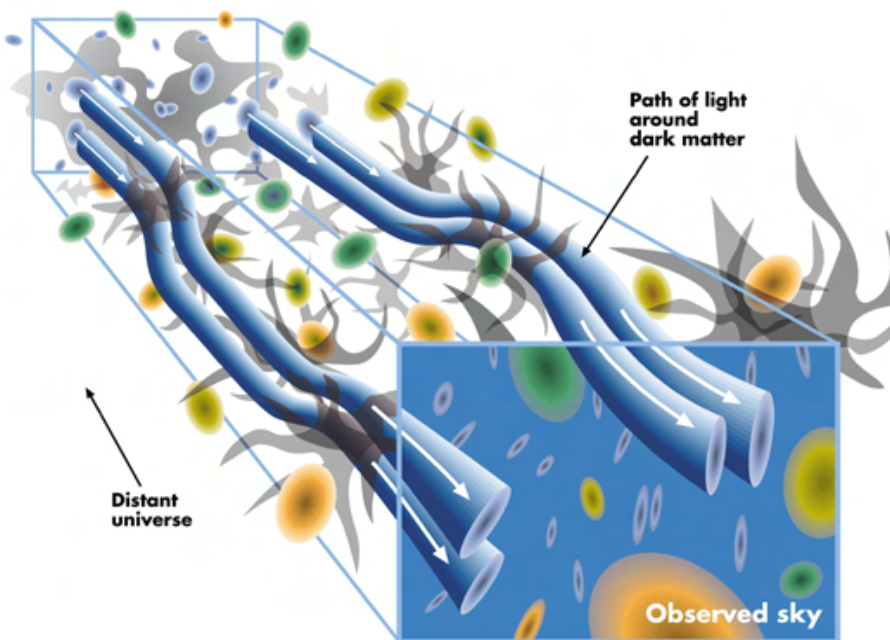

About a hundred-to-thousand-fold increase in precision over precursor experiments: the key is multiple probes!

Primer on Cosmology: what do astronomers measure?

Starting with Einstein's field equations:

$$R_{\nu}^{\mu} - \frac{1}{2}g_{\nu}^{\mu}R - \lambda g_{\nu}^{\mu} = 8\pi GT_{\nu}^{\mu} \quad (1)$$

(n.b. g_{ν}^{μ} “hides” the Robertson-Walker metric), one can derive the “astronomer’s” Friedmann equation

$$E^2(z) = \Omega_r(1+z)^4 + \Omega_m(1+z)^3 + \Omega_k(1+z)^2 + \Omega_{DE}f(z), \quad (2)$$

where

$$E^2(z) = \frac{H^2(z)}{H_0^2} = \left(\frac{1}{R} \frac{dR}{dt}\right)^2, \quad (3)$$

with $R(t)$ the scale factor of the Universe, H is for Hubble, and

$$f(z) = \exp\left(3 \int_0^z \frac{1+w(z')}{1+z'} dz'\right). \quad (4)$$

The dark energy equation of state is described by $w(z) = p/(\rho c^2)$ [for $w(z) = -1$, $f(z) = 1$ and $\Omega_{DE} \equiv \Omega_{\Lambda}$].

Cosmological Probes

The comoving (line-of-sight) distance

$$D_C(z) = D_H \int_0^z \frac{dz'}{\left(\Omega_m(1+z')^3 + \Omega_k(1+z')^2 + \Omega_{DE}f(z')\right)^{1/2}} \quad (5)$$

where $D_H = c/H_0 = 4.2$ Gpc is the Hubble distance, is then easily related to **luminosity distance** (measured using standard candles), **angular diameter distance** (measured using standard rulers), and **lookback time** (measured using standard clocks).

Also, **the growth of structure** (measured with weak lensing, clusters, etc.) is described by

$$g(z) = \frac{5\Omega_m E(z)}{2} \int_0^z \frac{(1+z')}{E(z')^{3/2}} dz'. \quad (6)$$

Astronomers measure $D_C(z)$ and thus constrain the function $E(z)$, and in turn, the model parameters Ω_m , Ω_k , Ω_{DE} and the favored parametrization of the dark energy equation of state, $w(z)$ (currently typically two free parameters).

CMB

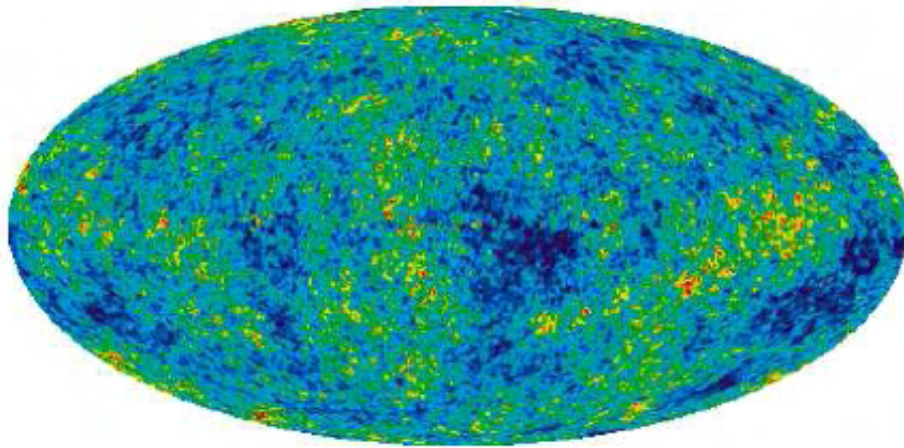

Galaxies

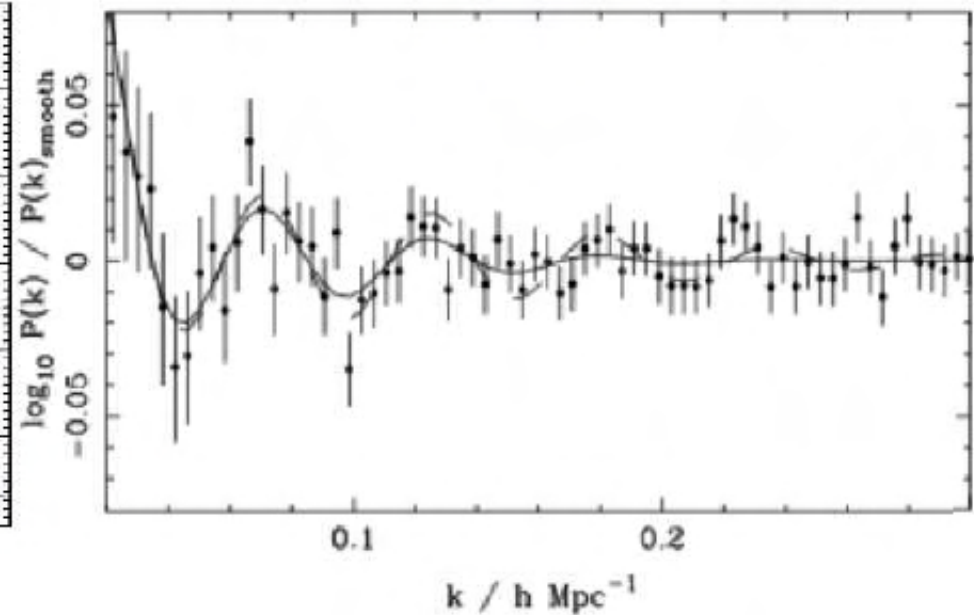
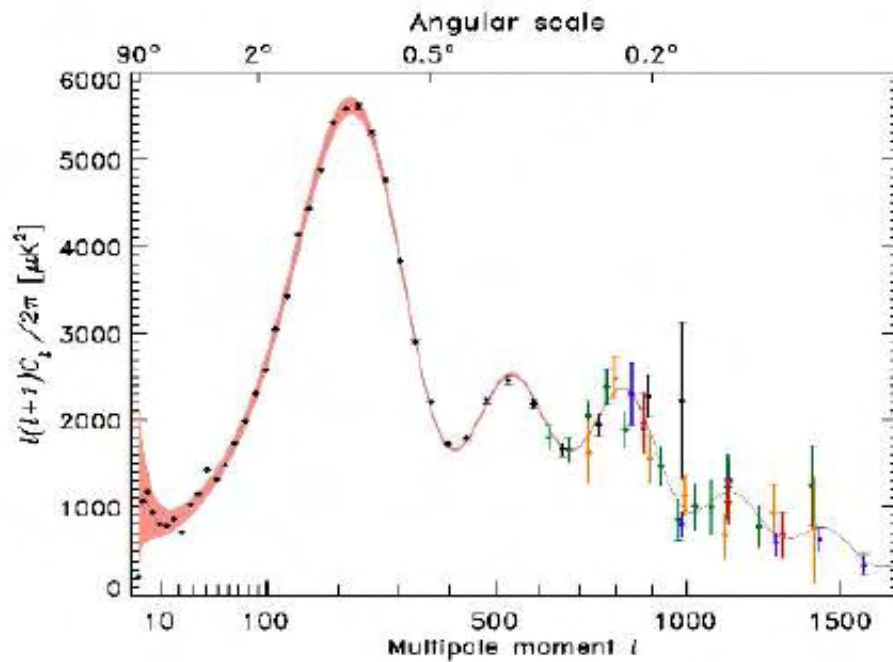
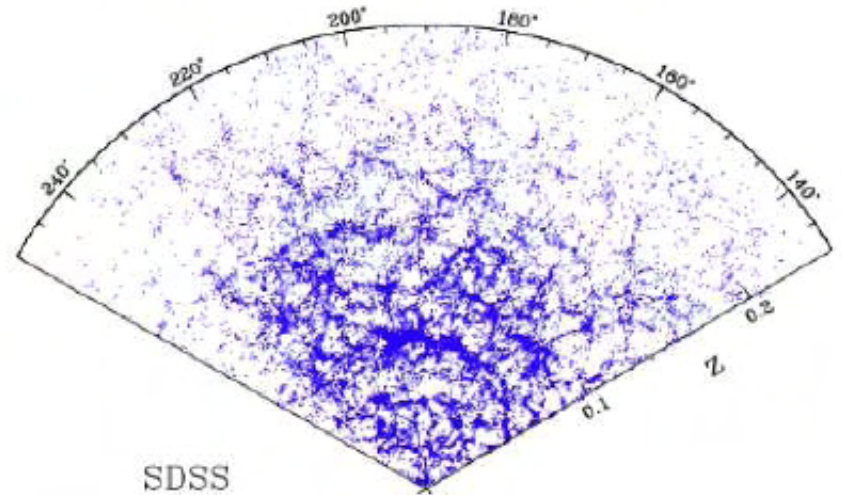

Baryon acoustic oscillations: standard ruler – new cosmological tool

LSST Science Drivers

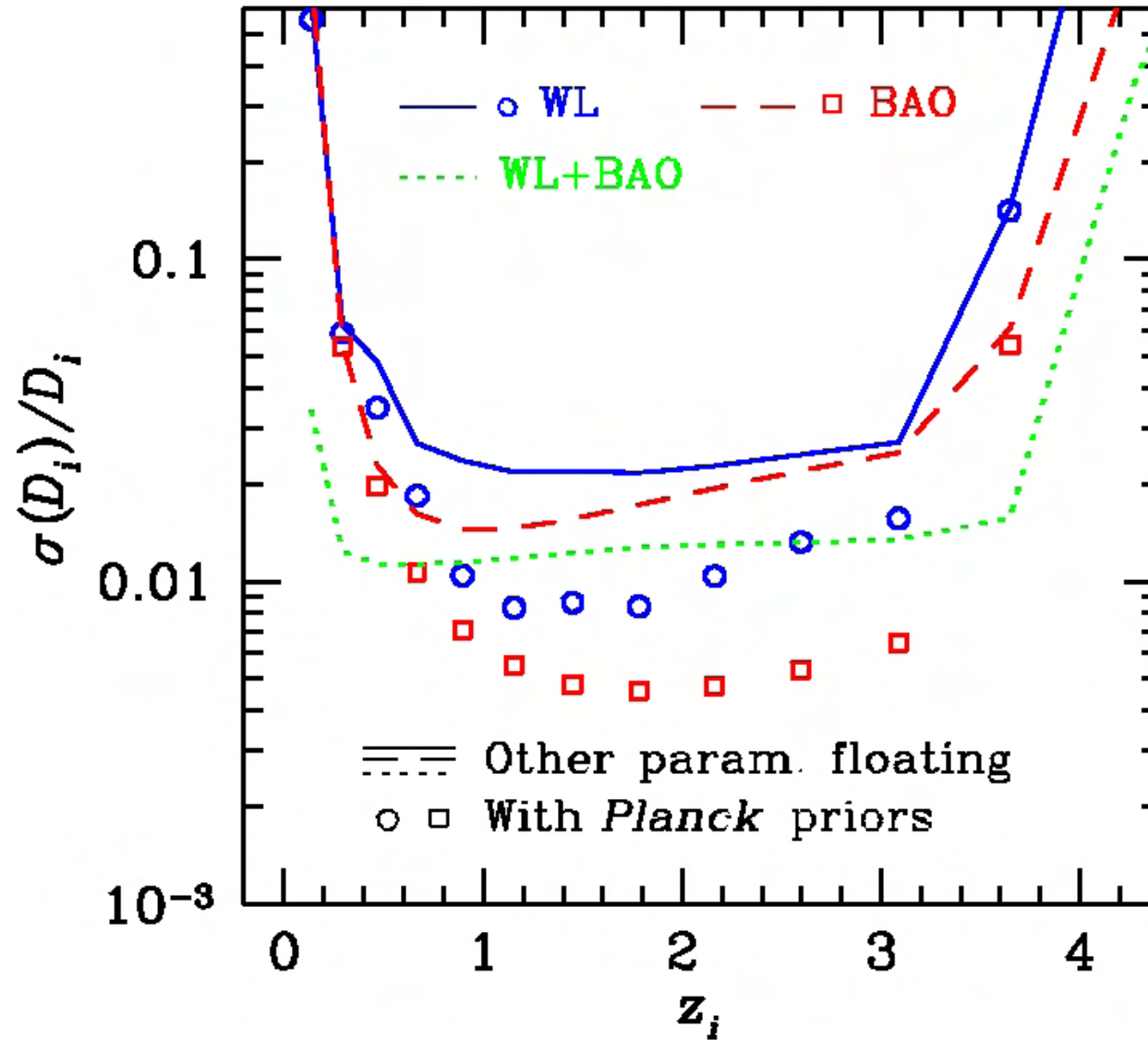

(Zhan, Knox & Tyson 2008, in prep)

LSST Science Drivers

- The Fate of the Universe (Dark Energy and Matter): use a variety of probes and techniques in synergy to fundamentally test our cosmological assumptions and gravity theories:
 1. **Weak Lensing:** growth of structure
 2. **Galaxy Clusters:** growth of structure
 3. **Baryon Acoustic Oscillations:** standard ruler
 4. **Supernovae:** standard candle

About a hundred-to-thousand-fold increase in precision over precursor experiments: Stage IV Experiment (Dark Energy Task Force nomenclature)

Multiple accurate cosmological probes with the same facility (and data): by simultaneously measuring growth of structure and curvature, **LSST data will tell us whether the recent acceleration is due to dark energy or modified gravity.**

The Solar System Inventory

Studies of the distribution of orbital elements as a function of color and size; studies of object shapes and structure using colors and light curves.

- **Near-Earth Objects:** about 100,000 **LSST is the only survey capable of delivering completeness specified in the 2005 Congressional NEO mandate to NASA** (to find 90% NEOs larger than 140m)
- **Main-Belt Asteroids:** about 10,000,000
- **Centaurs, Jovian and non-Jovian Trojans, trans-Neptunian objects:** about 200,000
- **Jupiter-family and Oort-cloud comets:** about 3,000–10,000, with hundreds of observations per object
- **Extremely distant solar system:** the search for objects with perihelia at several hundred AU (e.g. Sedna will be observable to 200-300 AU).

Solar System as a detailed test of planet formation theories (just like the Galaxy is a detailed test of galaxy formation theories)

Time Domain: Exploring the Unknown

- Characterize known classes of transient and variable objects, and discover new ones: a variety of time scales ranging from ~ 10 sec, to the whole sky every 3 nights, and up to 10 yrs; large sky area, faint flux limit (as many **variable** stars in LSST as **all** stars in SDSS: ~ 100 million)
- Transients will be reported within 30 sec of closing shutter

Time Domain: Exploring the Unknown

- Characterize known classes of transient and variable objects, and discover new ones: a variety of time scales ranging from ~ 10 sec, to the whole sky every 3 nights, and up to 10 yrs; large sky area, faint flux limit (as many **variable** stars in LSST as **all** stars in SDSS: ~ 100 million)
- Transients will be reported within 30 sec of closing shutter

Not only point sources: echo of a supernova explosion (by Andy Becker)

Science Image

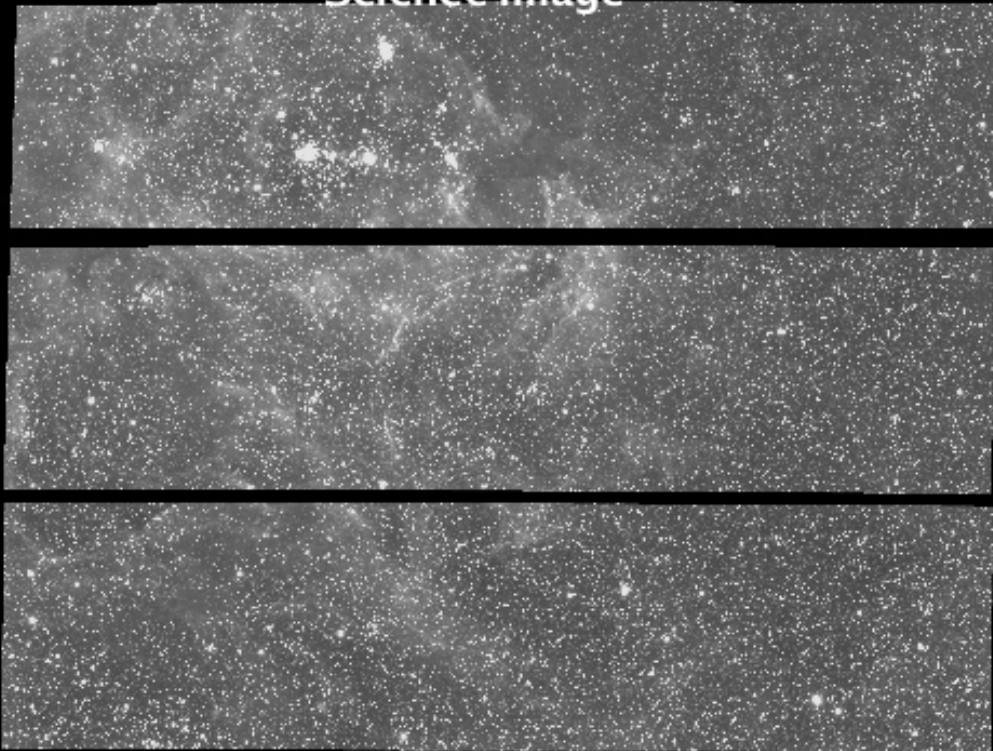

Difference Image (Science - Reference)

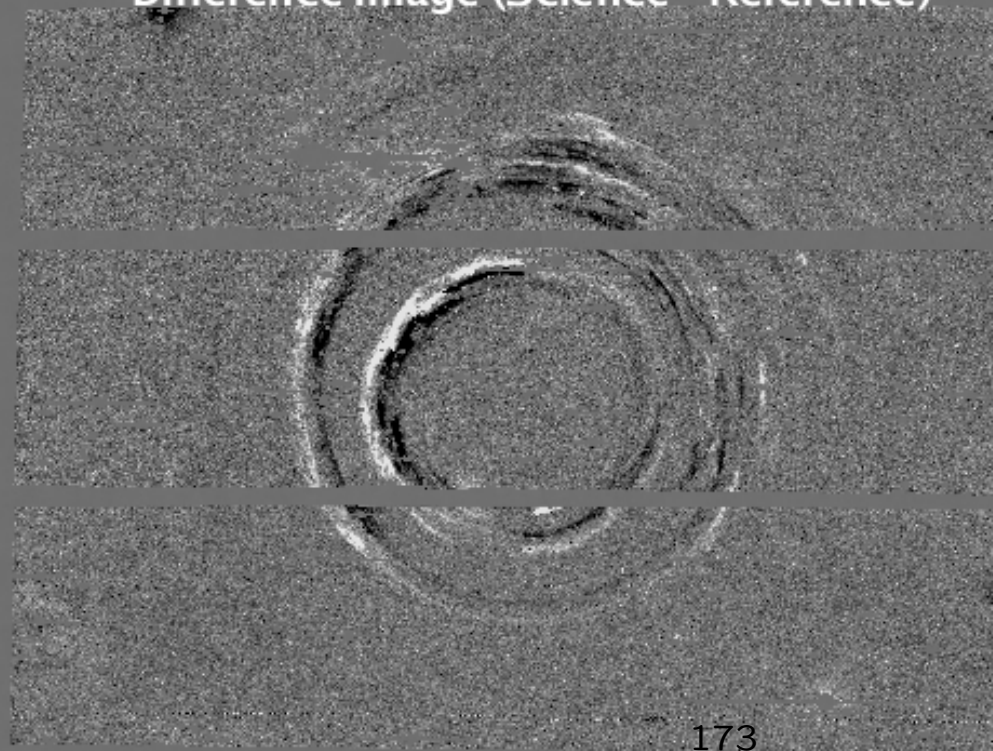

Deciphering the Past

- Map the Milky Way all the way to its edge with high-fidelity to study its formation and evolution:
 - about 10 billion stars
 - hundreds of millions of halo main-sequence stars to 100 kpc
 - RR Lyrae stars to 400 kpc
 - geometric parallaxes for all stars within 500 pc
 - kinematics from proper motions (extending Gaia 4 mag)
 - photometric metallicity (the u band rules!)

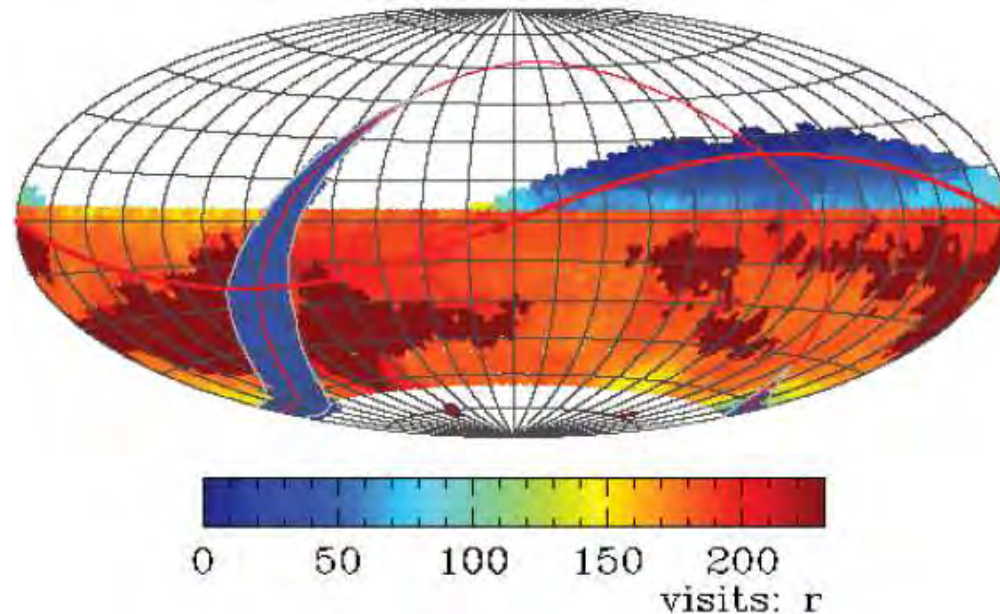

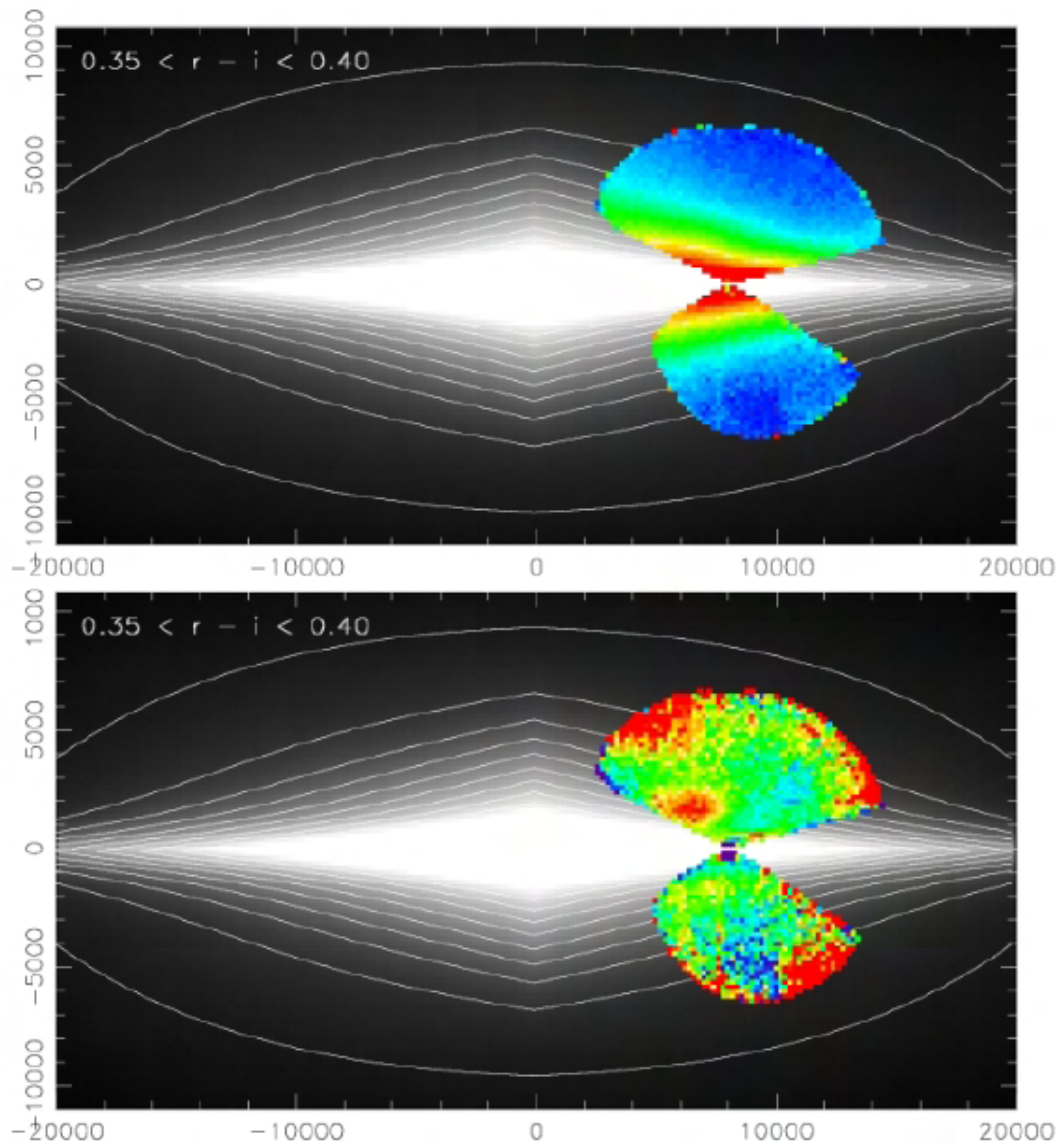

The limitations of SDSS data and LSST

- **Sky Coverage:** “only” $\sim 1/4$ of the sky $1/2$ of the sky
- **Depth:** main-sequence stars to ~ 10 kpc; RR Lyrae stars to 100 kpc 100 and 400 kpc
- **Photometric Accuracy:** ~ 0.02 mag for the u band, limits the accuracy of photometric metallicity estimates to ~ 0.2 dex 0.01 mag and 0.1 dex
- **Astrometric Accuracy:** the use of POSS astrometry (accurate to ~ 150 mas after recalibration) limits proper motion accuracy to 3 mas/yr 0.2 mas/yr at $r=21$ and 1.0 mas/yr at $r=24$

The large blue circle: the ~ 400 kpc limit of future LSST studies based on RR Lyrae

The large red circle: the ~ 100 kpc limit of future LSST studies based on main-sequence stars (and the current limit for RR Lyrae studies)

LSST limit for RR Lyrae: 400 kpc

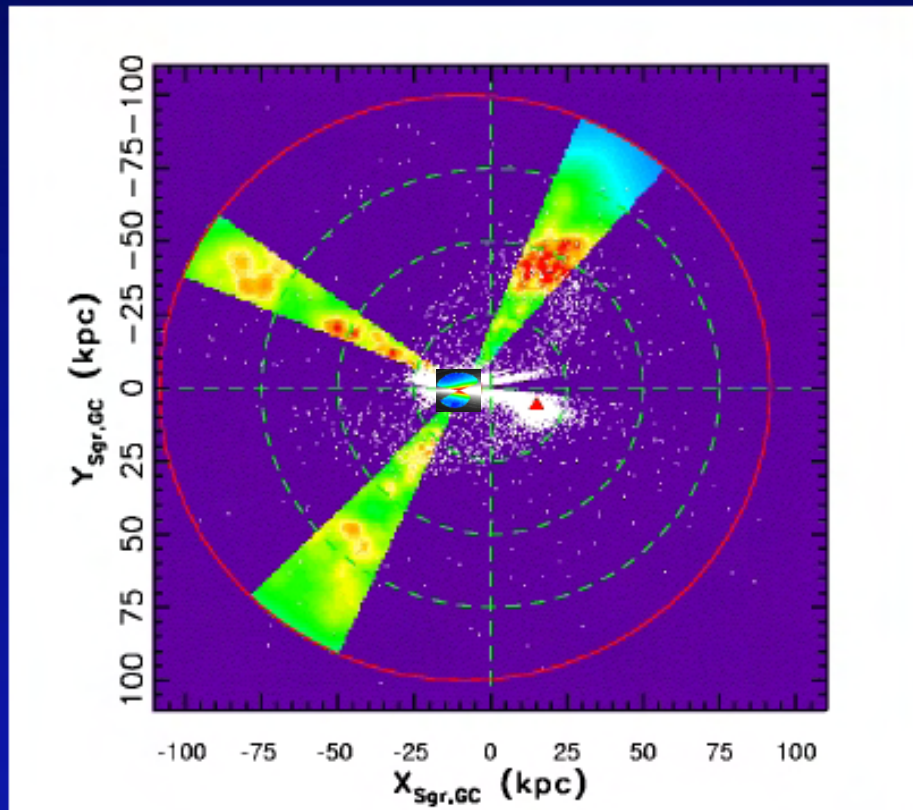

The small insert:
 ~ 10 kpc limit of SDSS and future Gaia studies for kinematic & $[Fe/H]$ mapping with MS stars

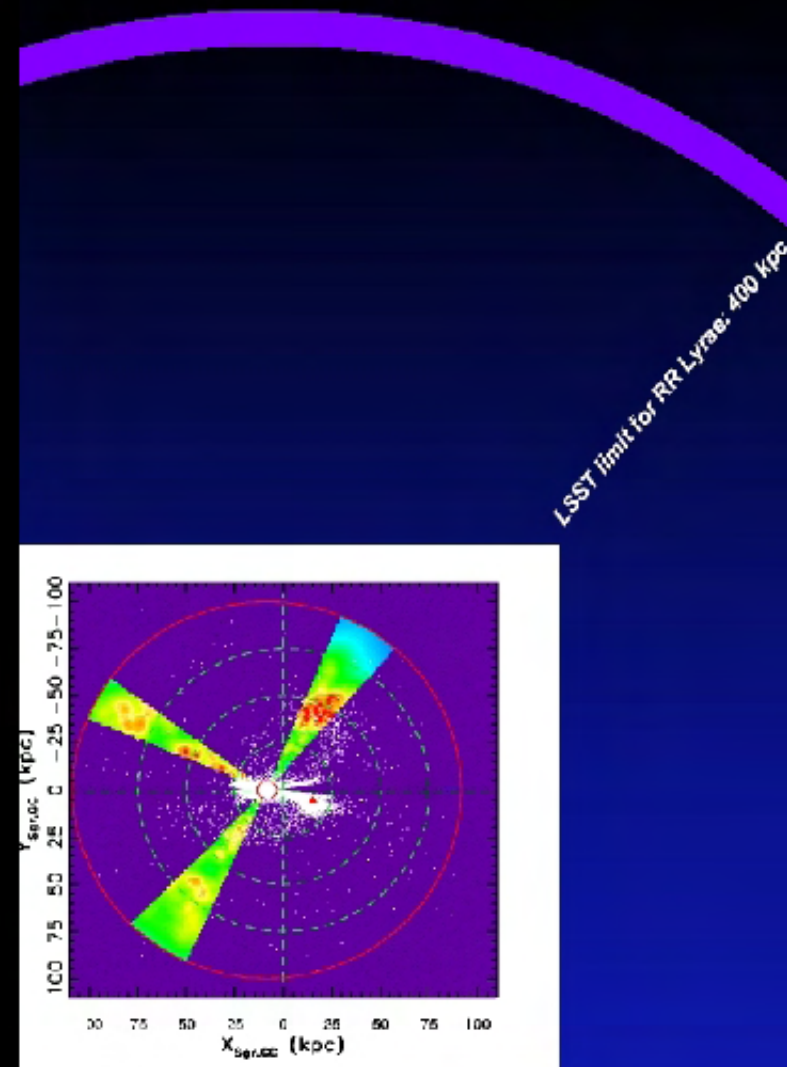
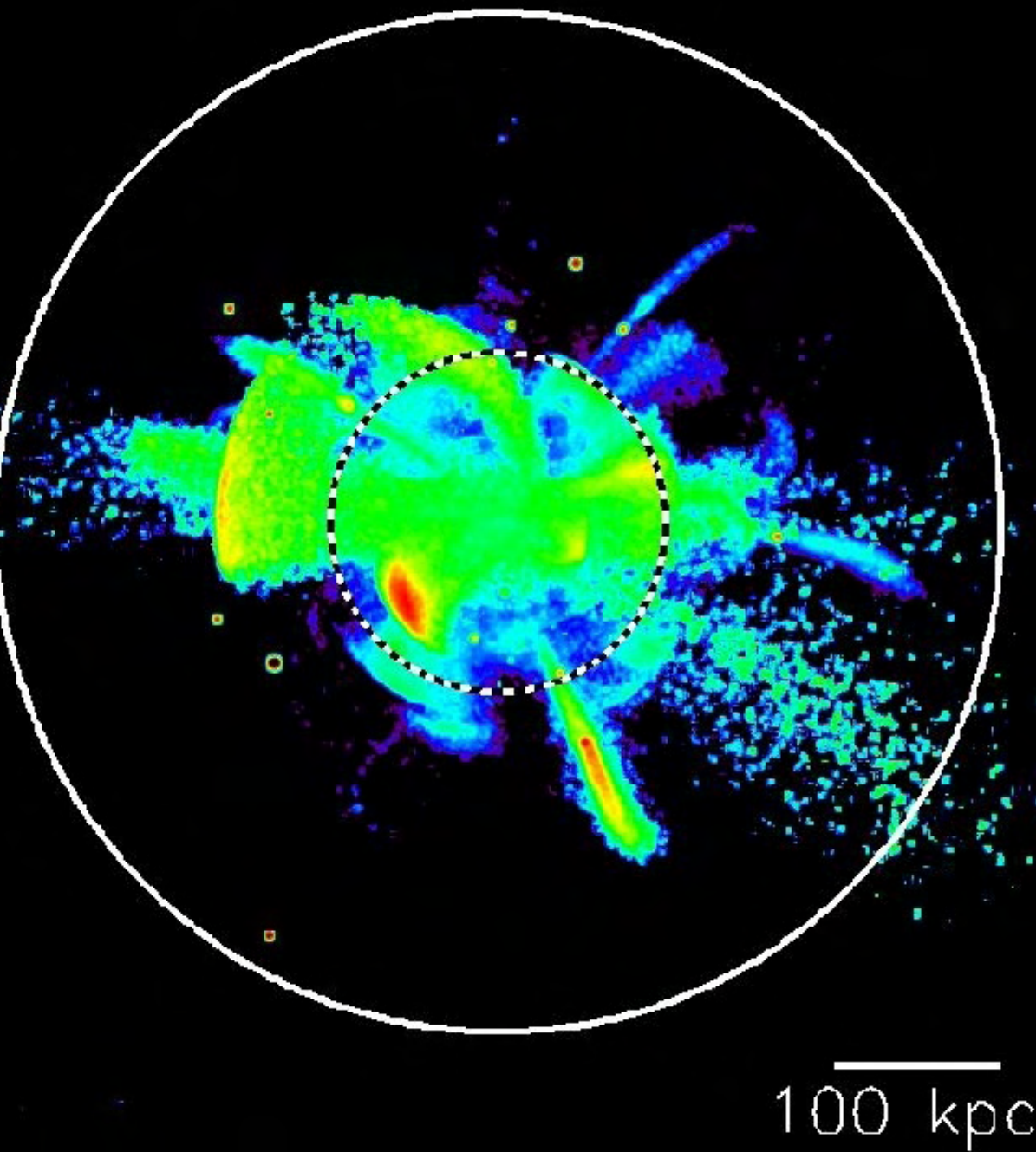

Left: Models (Bullock & Johnston) **Right:** SDSS and 2MASS observations, and predictions for LSST¹⁷⁷

“Other” science

- **Quasars:** discovered using colors and variability; about 10,000,000 in a “high-quality” sample; will reach $M_B = -23$ even at redshifts beyond 3
- **Galaxies:** color-morphology-luminosity-environment studies in thin redshift slices to $z \sim 3$ (high-SNR sample of 4 billion galaxies with $i < 25$)

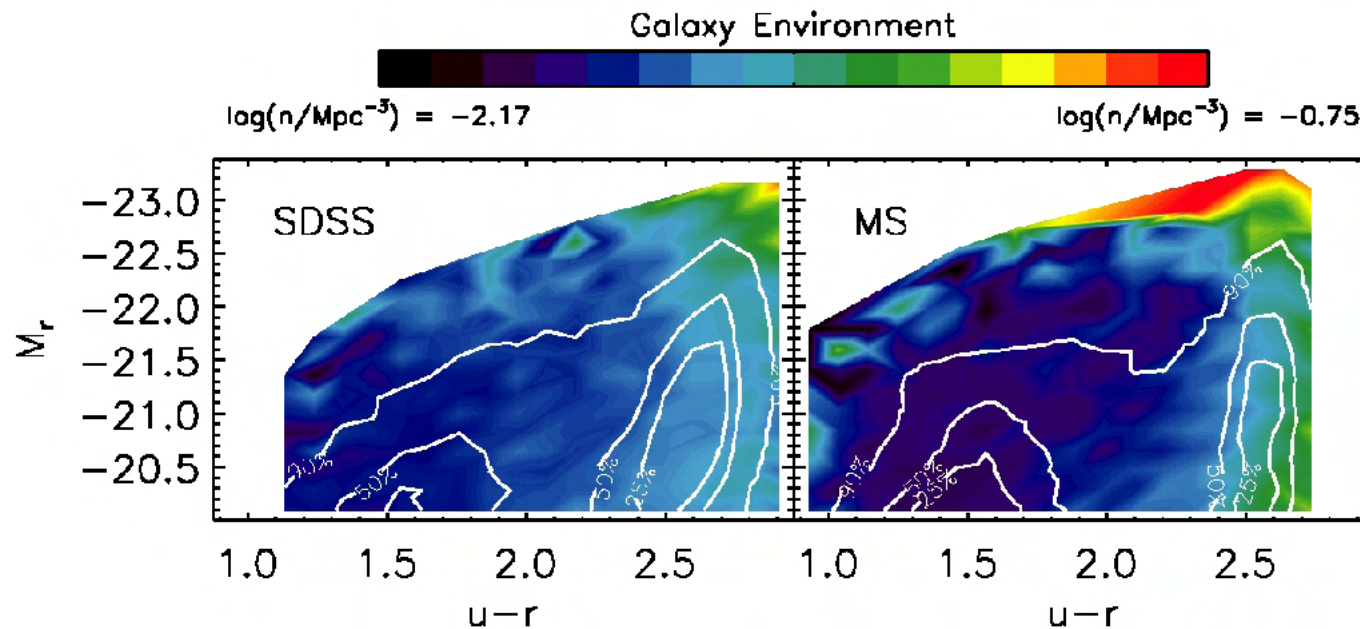
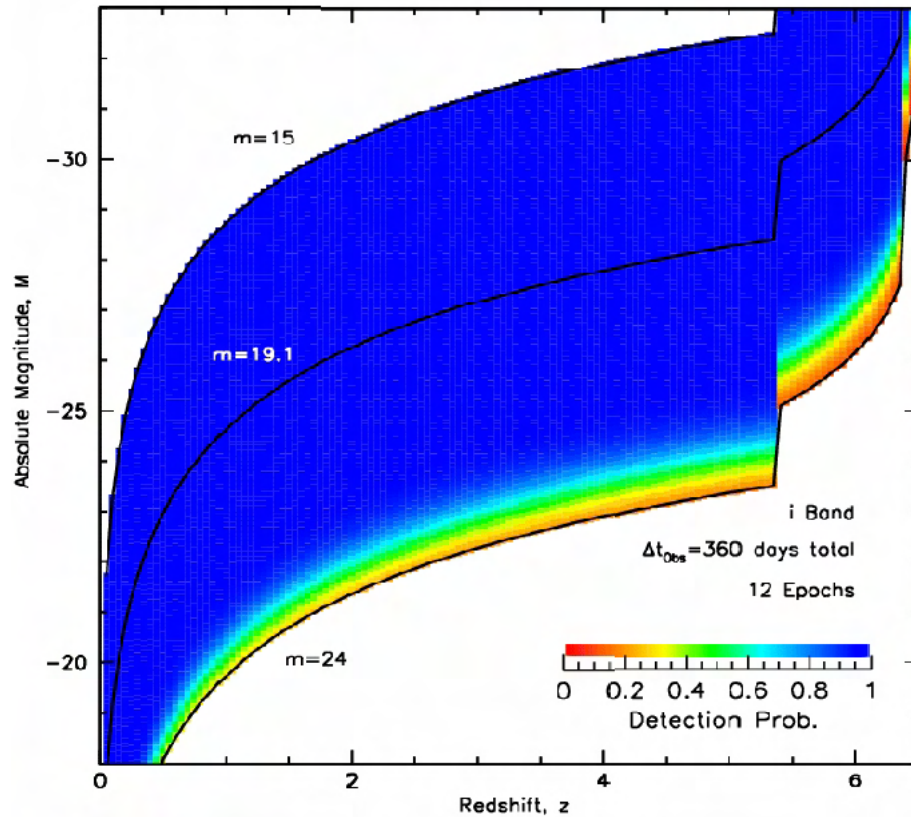

If you liked SDSS, you'll love LSST:

- **The Best Sky Image Ever:** 60 petabytes of astronomical image data (resolution equal to 3 million HDTV sets)
- **The Greatest Movie of All Time:** digital images of the entire observable sky every three nights, night after night, for 10 years (11 months to “view” it)
- **The Largest Astronomical Catalog:** 20 billion sources (for the first time in history more than living people)

But the total impact of LSST may turn out to be much larger than that directly felt by the professional astronomy and physics communities: with an open 60 PB large database that is available in real-time to the public at large, LSST will bring the Universe home to everyone. (it's so cool to be an astronomer!)

For more details: [astro-ph/0805.2366](https://arxiv.org/abs/astro-ph/0805.2366)

The Lecture Plan: More Questions?

1. Lecture I:

- Brief overview of survey astronomy
- Introduction to SDSS
- What SDSS data exist and how to access them

2. Lectures II and III: Examples of SDSS Science

- Solar System, Stars and the Milky Way
- Galaxies, AGNs, Quasars and Cosmology

3. Lecture IV: SDSS is not everything!

- Other Wavelengths
- Back to the Future: from SDSS to LSST