

ASTRONOMICAL REFERENCE SYSTEMS AND FRAMES, ASTROMETRIC TECHNIQUES AND CATALOGS

Jan Vondrák, Astronomical Institute, Prague

■ PART 2:

- ◆ Astrometric techniques used to realize the reference frames;
- ◆ Astrometric star catalogs.



Astrometric techniques and star catalogs

- **ASTROMETRY** - one of the oldest astronomical disciplines
 - ◆ Determination of positions, dimensions and shapes of celestial bodies, and their temporal changes;
 - ◆ application of astrometric techniques of observation to determine
 - geometric,
 - kinematic,
 - dynamic
 - ◆ properties of celestial bodies.
- Increasing accuracy \Rightarrow new discoveries / validation of new theories



Astrometric techniques

- **Astrometry with a narrow field of view - to measure small angles between celestial objects (up to a few degrees):**
 - ◆ **Photography (since 1870-1875), examples:**
 - **Classical astrograph (Carte de Ciel, 1890-1910, 40/410cm);**
 - **Schmidt telescope (plate correcting spherical aberration, app. 100/300cm);**
 - **astrometric long-focus telescope (150/1500cm);**
 - ◆ **visual micrometer;**
 - ◆ **Grid + photometer in focal plane;**
 - ◆ **CCD (replacement of a photographic plate);**
 - ◆ **interferometry;**



- **Global astrometry - to measure large angular distances between celestial objects (tens of degrees):**
 - ◆ meridian circle, vertical circle, transit instrument;
 - ◆ instruments of astrolabe type for the method of equal altitudes;
 - ◆ Photographic Zenith Tube (PZT);
 - ◆ Hipparcos;
 - ◆ optical phase interferometer;
 - ◆ Very-long baseline interferometry (VLBI);
- **Direct measurement of distances (so far only within the solar system):**
 - ◆ radar;
 - ◆ laser;
- **Indirect measurement of distances:**
 - ◆ annual parallax;



Annual trigonometric parallax

$$r = 1/\pi \text{ [a.u.]}$$

$$\Rightarrow \sigma_r = r^2 \sigma_\pi$$

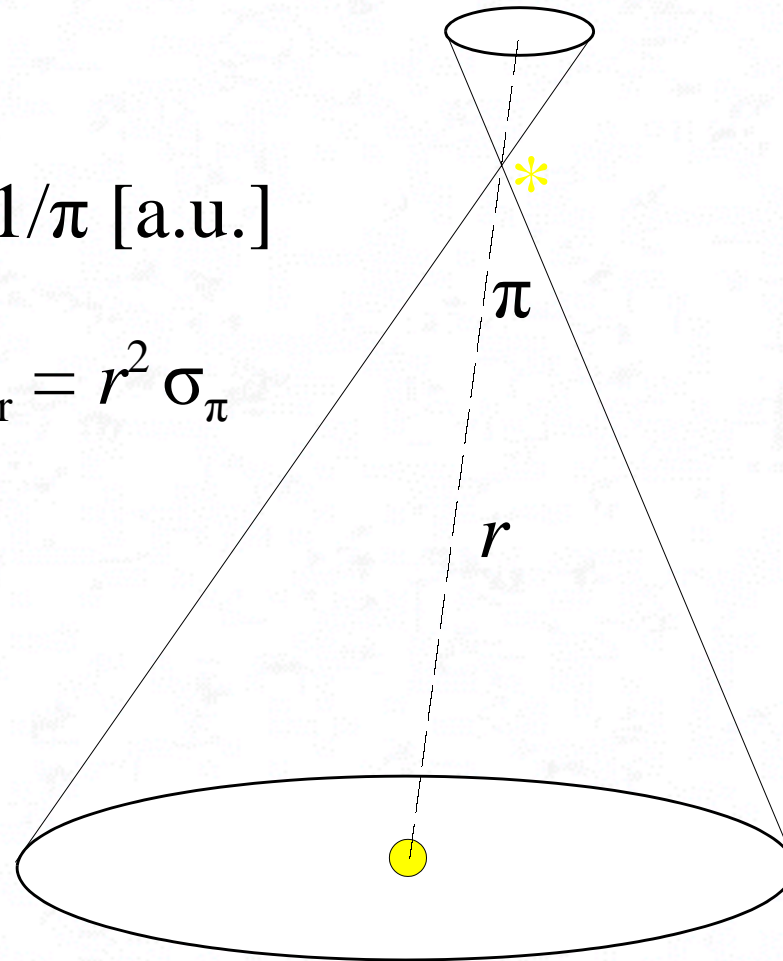

Observatory of Ulugh-Beg, Samarkand, 15th century

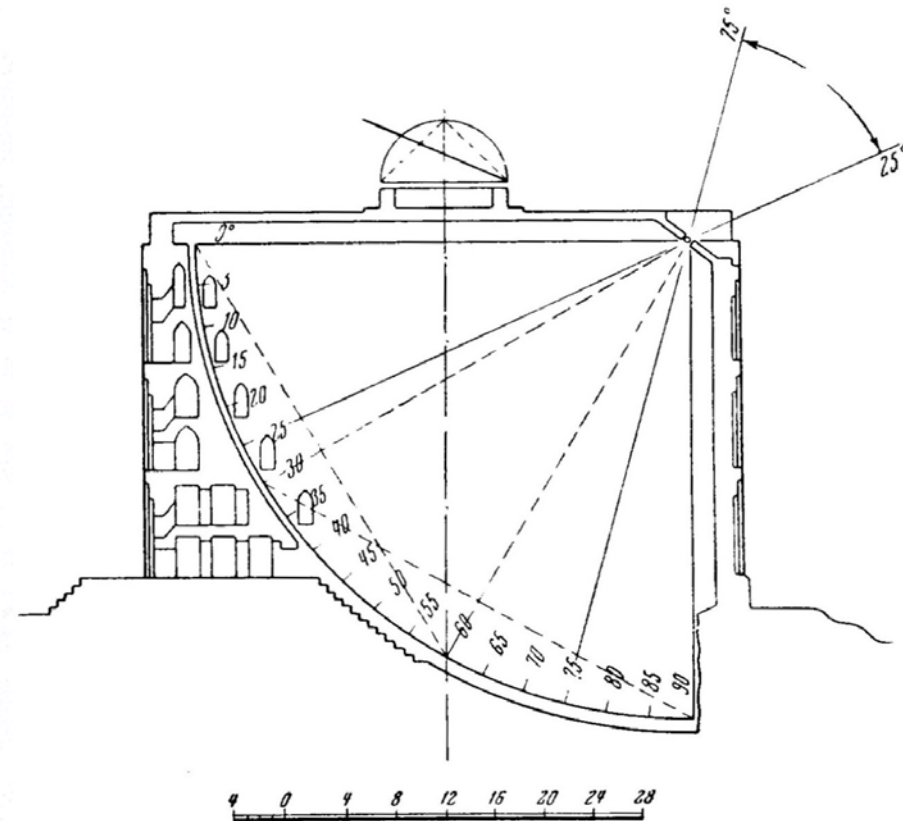
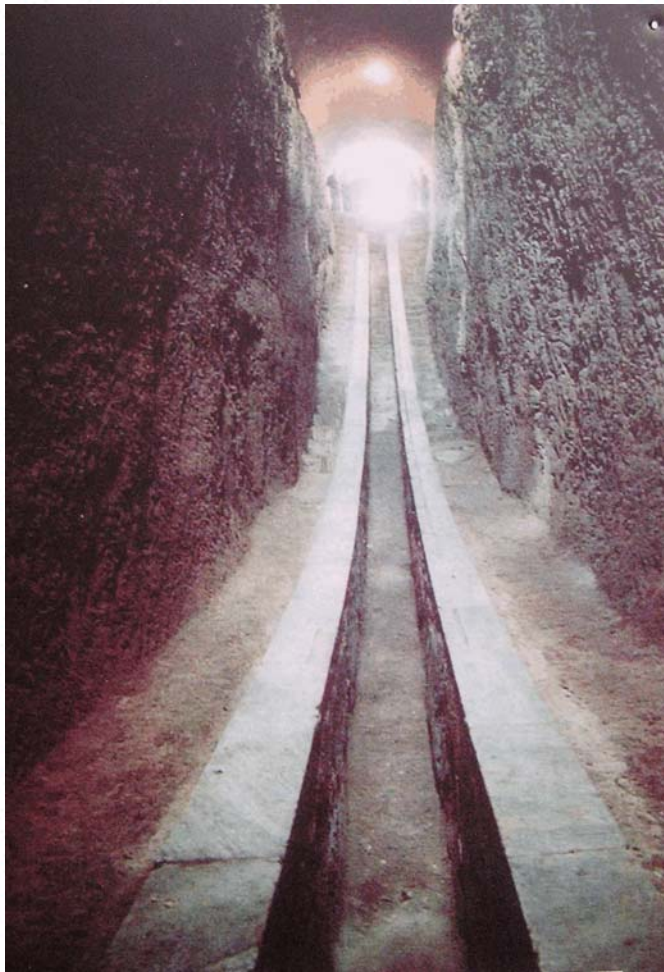

Summer School in Astronomy and Geophysics, Belgrade, August 2007

Armillary sphere, China, 15th century (replica)

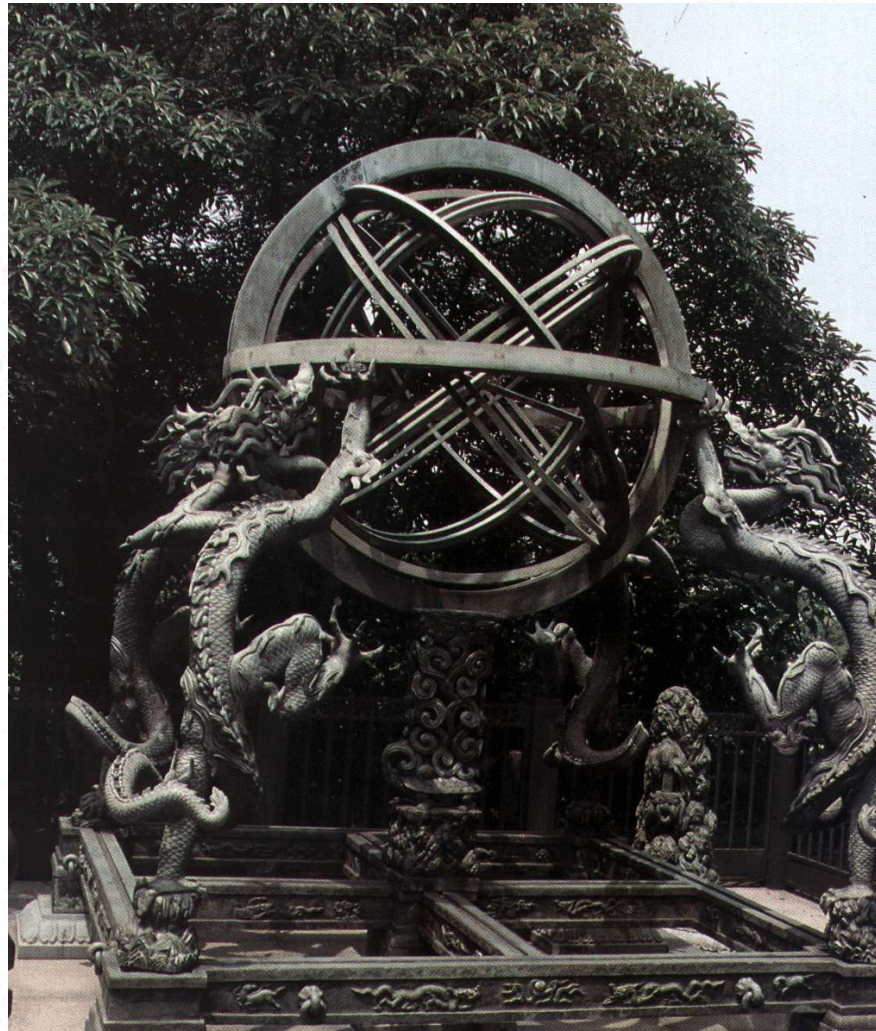

Summer School in Astronomy and Geophysics, Belgrade, August 2007



Habermel's sextant (end of 16th century)



Summer School in Astronomy and Geophysics, Belgrade, August 2007

Large transit instrument (Royal Greenwich Obs.)

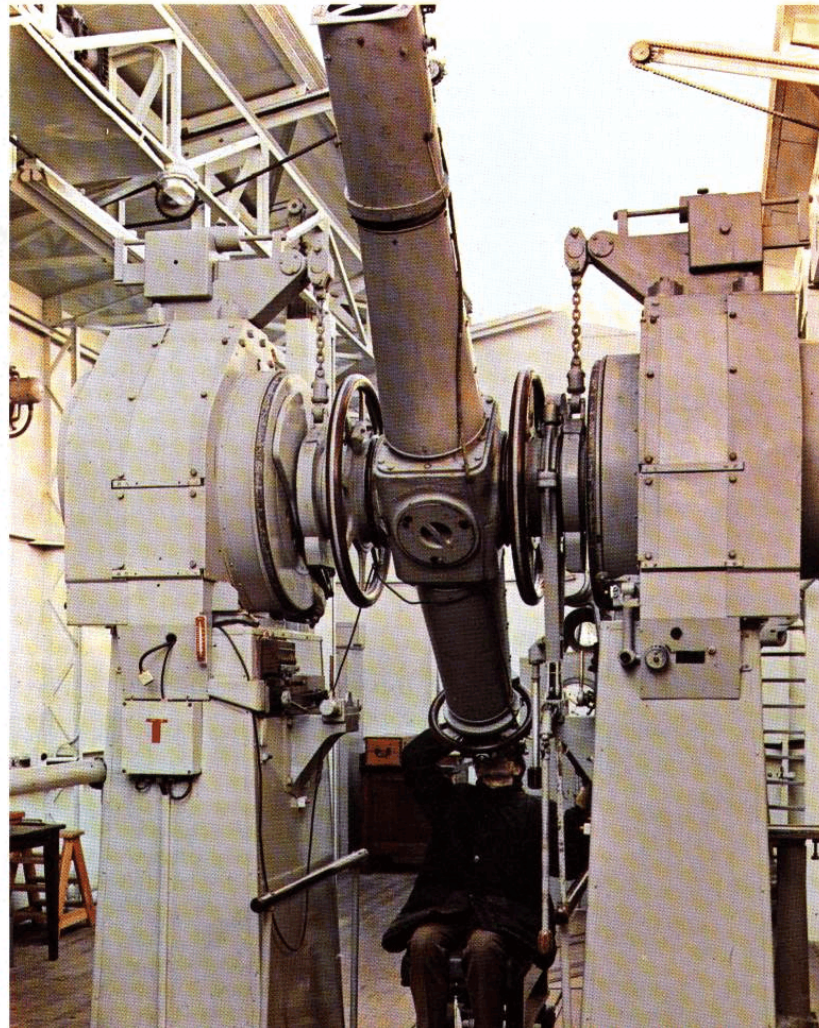

Summer School in Astronomy and Geophysics, Belgrade, August 2007

Astrometric telescope, Flagstaff



Summer School in Astronomy and Geophysics, Belgrade, August 2007

Automatic meridian circle, Bordeaux

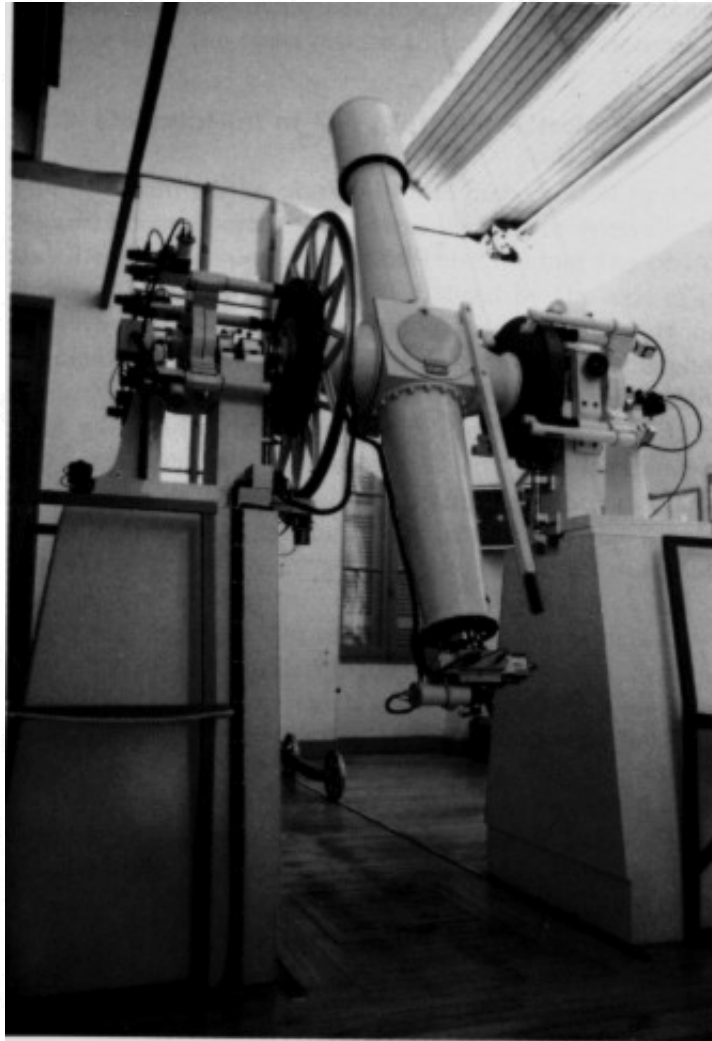

Summer School in Astronomy and Geophysics, Belgrade, August 2007

Automatic vertical circle, Yunnan

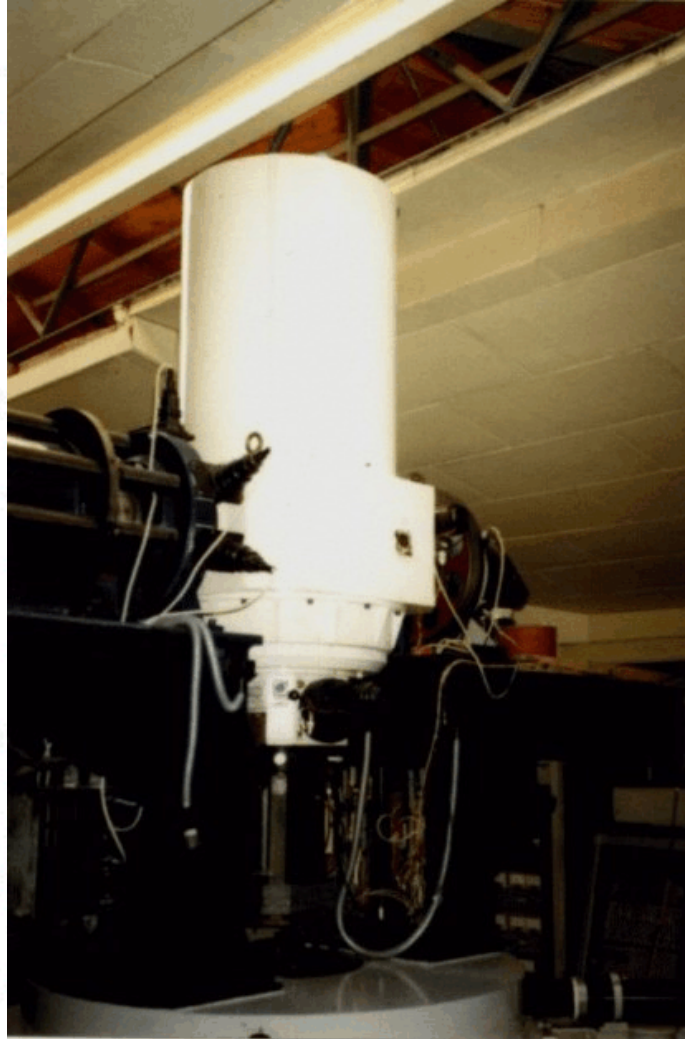

Summer School in Astronomy and Geophysics, Belgrade, August 2007

Photoelectric astrolabe, Yunnan

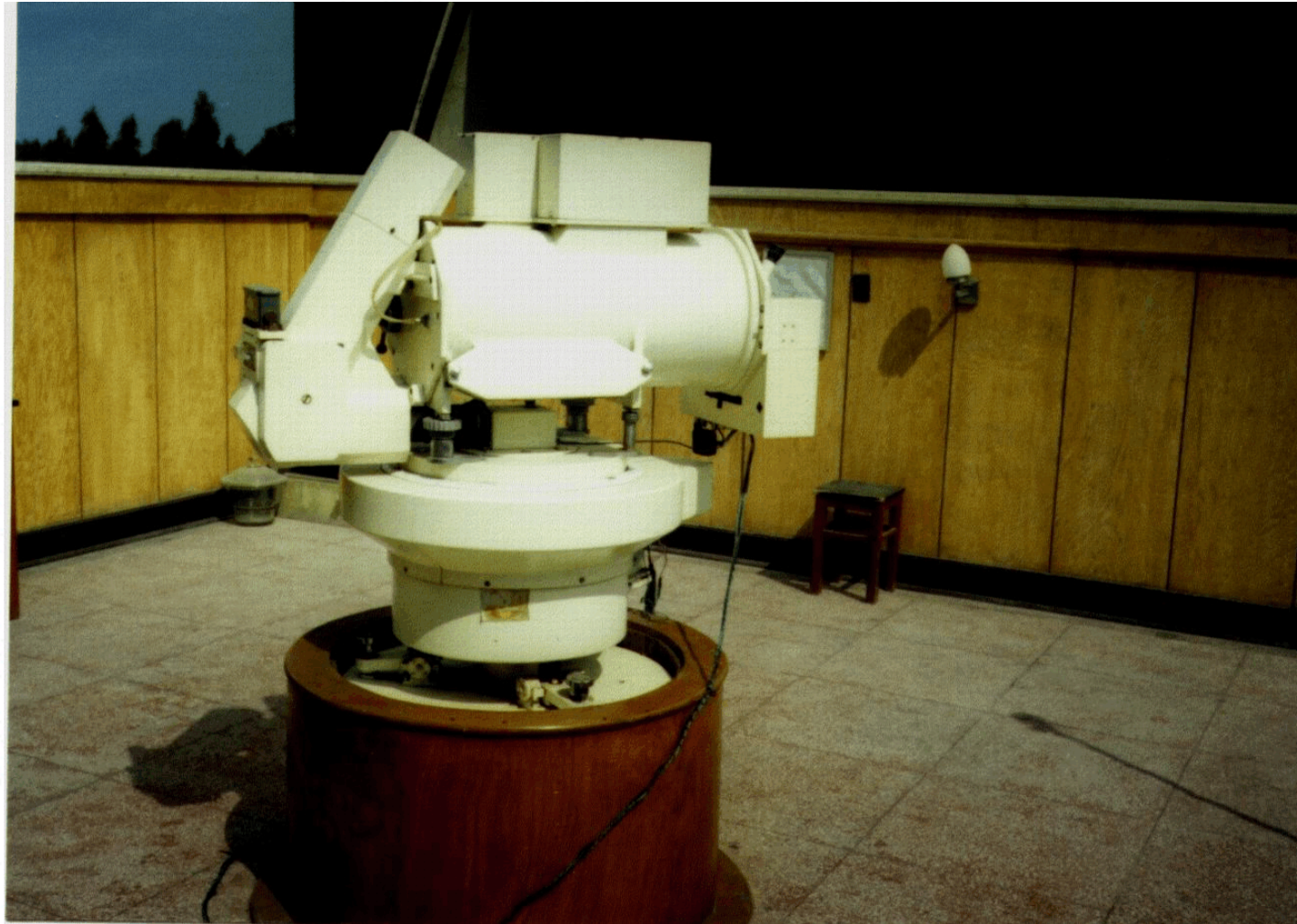

Summer School in Astronomy and Geophysics, Belgrade, August 2007

25m antenna VLBI (She-Shan near Shanghai)



Summer School in Astronomy and Geophysics, Belgrade, August 2007

Hipparcos satellite before launch

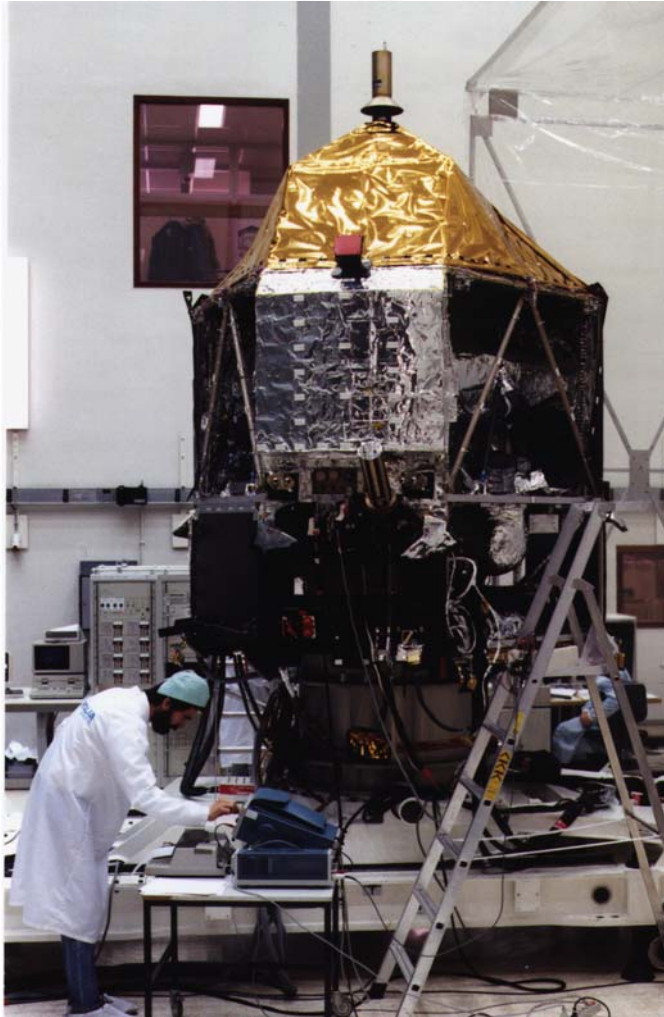

Summer School in Astronomy and Geophysics, Belgrade, August 2007

Astrometric star catalogs:

- position at mean epoch t_0 and standard equinox (e.g., B1900.0, B1950.0, J2000.0): α_0, δ_0
- proper motion: μ_α, μ_δ
- magnitude: m
- {spectral class: Sp }
- {parallax: π }
- {radial velocity: RV }



- Accuracy of the catalog is characterized by mean errors:
 - ◆ in position for mean epoch of the catalog: σ_α , σ_δ
 - ◆ in proper motions: $\sigma_{\mu\alpha}$, $\sigma_{\mu\delta}$
- Accuracy for any epoch t :
 - ◆ $\sigma^2(t) = \sigma_o^2 + \sigma_\mu^2(t - t_o)^2$



Historical overview of some catalogs

Technique	Author	Epoch	accuracy	Ref. system
eye	Hipparchos	-128	15'	ecliptical
--	Ptolemaios	138	15'	--
--	Ulugh Beg	1438	10'	--
--	Tycho Brahe	1601	2'	--
eye, telescope	Hevelius	1661	1'	ecliptical, equatorial
telescope	Flamsteed	1690	5"	equatorial
--	Bradley	1755	1-2"	--
--	Boss (GC)	1900	0.15"	--
--	Fricke (FK5)	1950	0.023"	--
VLBI	Ma (ICRF)	N/A	0.0004"	ICRS
Hipparcos	ESA	1991.25	0.0007"	--



Development of accuracy of astrometric catalogs

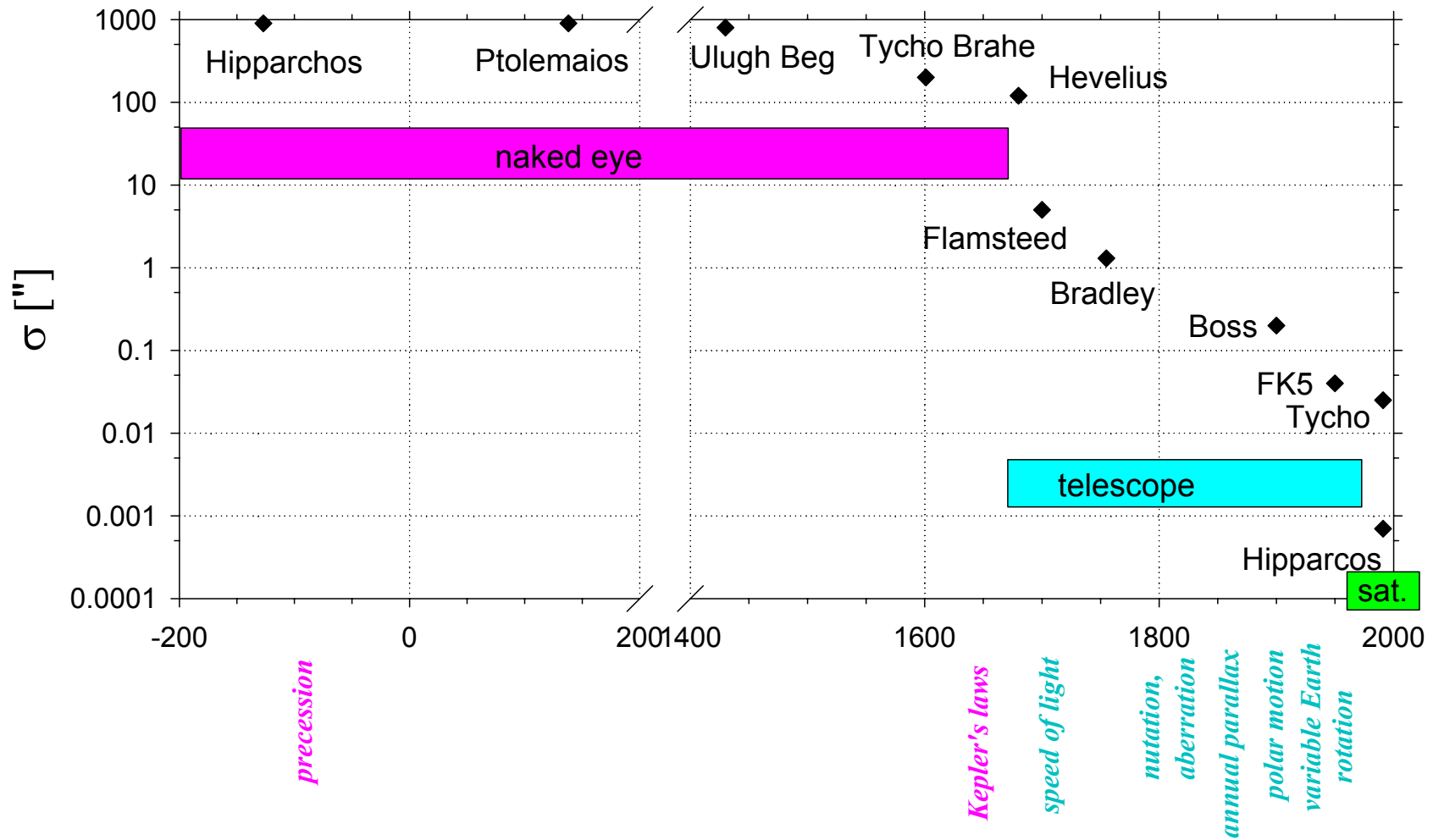

HIPPARCOS Catalogue

(High Precision PARallax COLlecting SAtellite)

- Satellite launched in August 1989, active until March 1993 (initial problems with geostationary orbit); equivalent of 37 months of observations collected.
- measuring of mutual angular distances between individual stars along great circle, whose orientation was slowly changing; each star was observed in average 30-50×.
- evaluation of observations was made in iterative 3 steps, in two independent centers - FAST (France, Italy, Germany, The Netherlands, USA), and NDAC (Denmark, Sweden, Great Britain):



- ◆ Photon count treatment from the star mapper (determination of great circle orientation), and from the main grid (determination of star coordinates on the grid);
- ◆ Reduction on a great circle (determination of angular distances of individual stars along a great circle, from an arbitrary origin);
- ◆ synthesis of all data on great circles ("sphere reconstitution") to determine 5 parameters for each star:
 $\alpha, \delta, \mu_\alpha, \mu_\delta, \pi$



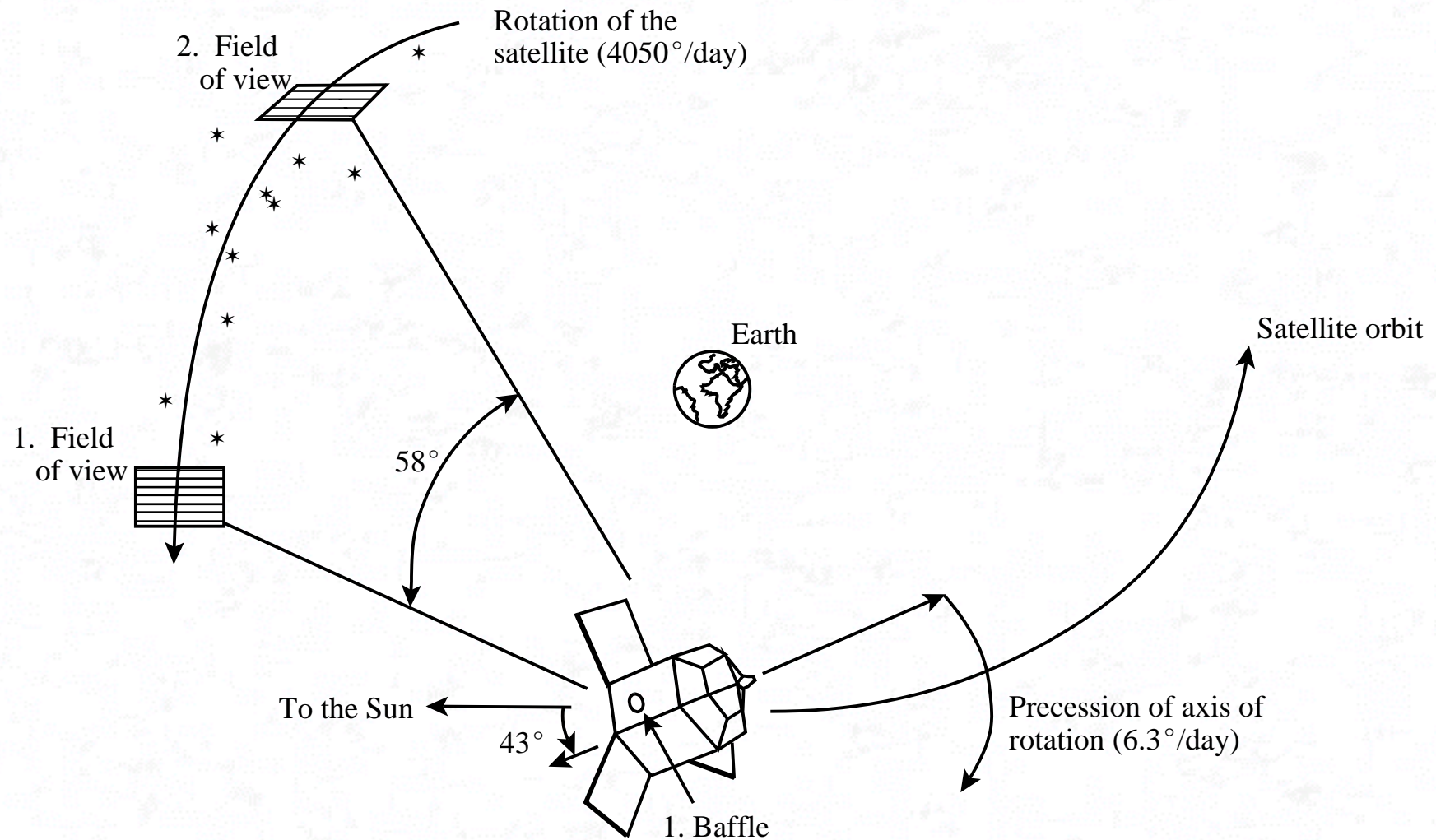

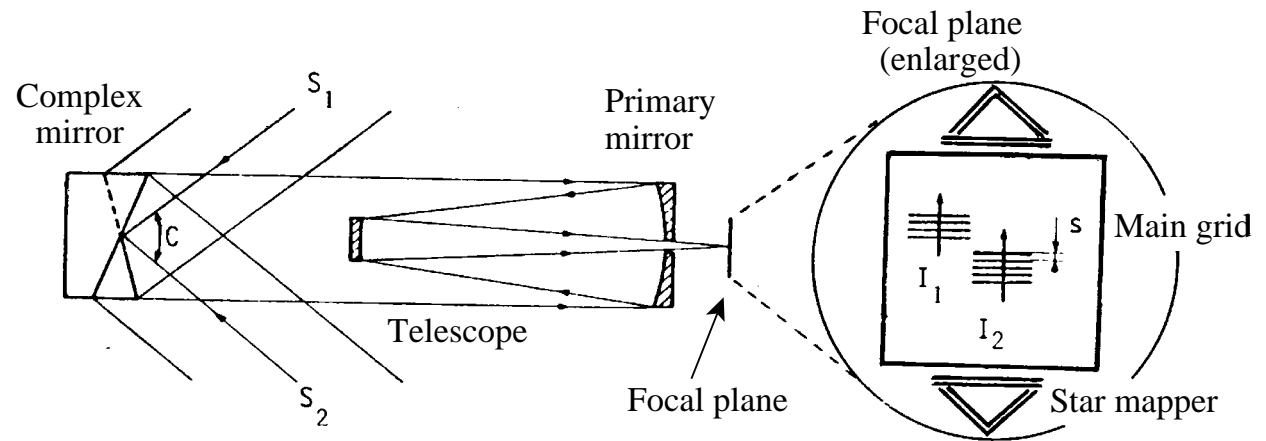
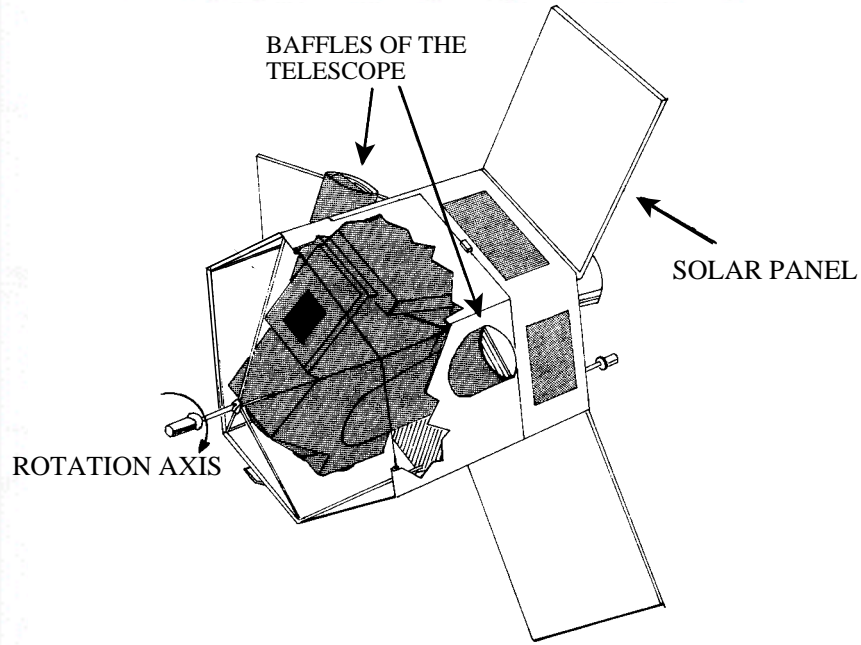

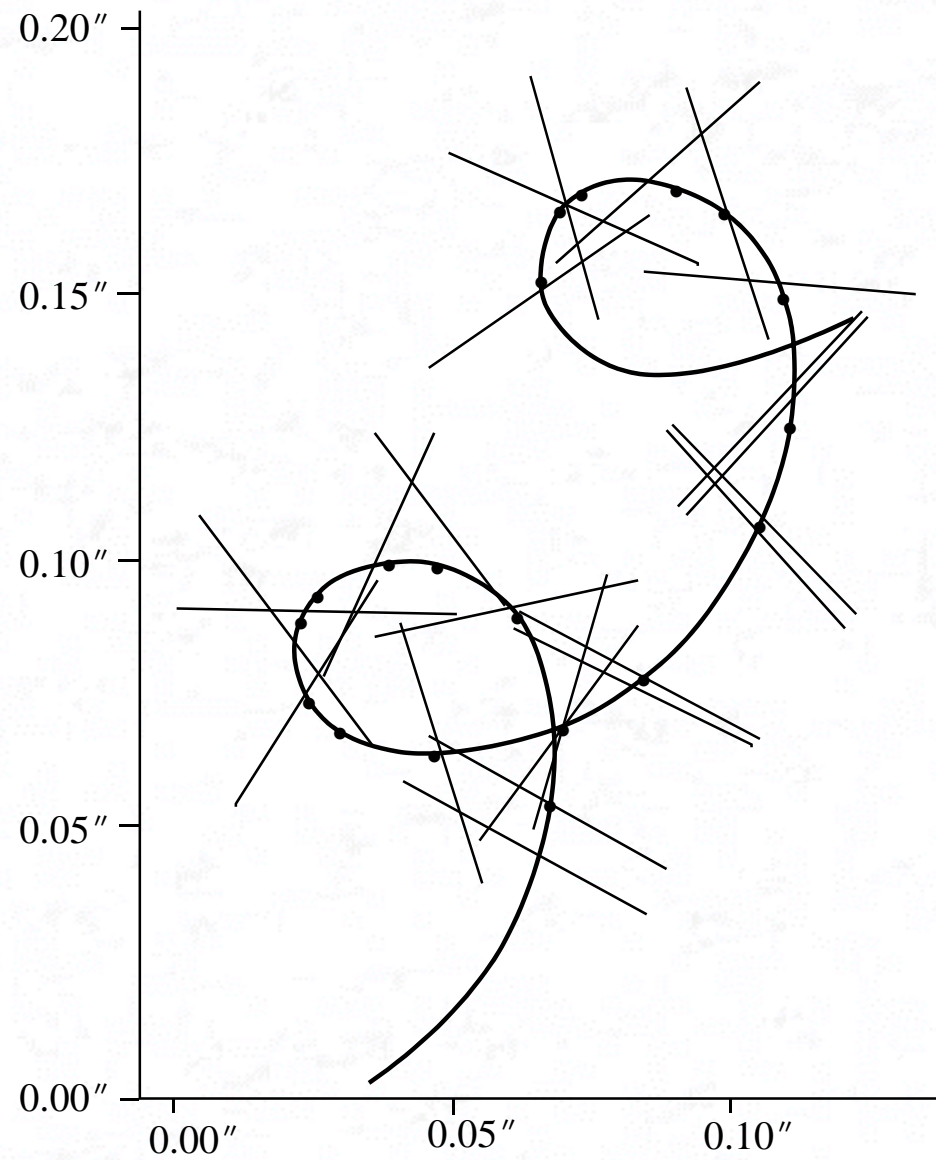

- The catalog determined this way has 6 degrees of freedom (any orientation and rotation); link to International Celestial Reference System (ICRS), defined by means of extragalactic radio sources, is necessary. This task was made by 11 teams, coordinated in France and Sweden:
 - ◆ VLBI (France),
 - ◆ MERLIN (Great Britain),
 - ◆ VLA (USA),
 - ◆ optical positions of compact sources (Hamburg/USNO),
 - ◆ HST (USA),



- ◆ Proper motions (Lick, USA),
 - ◆ Catalog of faint stars (Kiev, Ukraine),
 - ◆ Proper motions (Yale/San Juan, USA),
 - ◆ Photograph. positions in two epochs (Bonn, Germany),
 - ◆ Absolute proper motions (Potsdam, Germany),
 - ◆ Earth orientation parameters (Prague, Czech Republic).
- **Hipparcos Catalogue is linked to ICRS with accuracy of**
- ◆ **0.6mas in orientation at the epoch 1991.25,**
 - ◆ **0.25mas/year in rotation around all 3 axes.**



TYCHO Catalogue

- **Is a by-product of Hipparcos mission:**
 - ◆ **1 million of stars observed by Star Mapper to determine the attitude of the satellite;**
 - ◆ **Lower accuracy than Hipparcos: 0.025" in position at basic epoch 1991.25, 2.8"/cy in proper motions.**



“Post - Hipparcos” catalogs

- Proper motions often not precise, especially for double and multiple systems (short time of the mission); therefore attempts to combine Hipparcos / Tycho positions with ground-based catalogs:
 - ◆ FK6 (Wielen et al. 1999, 2000) - 878 + 3272 stars (Part I + III) - combination Hipparcos + FK5;
 - ◆ TYCHO-2 (Høg et al. 2000) - 2.5 million stars - combination of the second reduction of TYCHO + 144 ground-based catalogs;
 - ◆ GC+HIP (Wielen et al. 2001) - 20 thousand stars - combination Hipparcos + Boss General Catalogue;



- ◆ TYC2+HIP (Wielen et al. 2001) - 90 thousand stars - combination Hipparcos + Tycho-2;
- ◆ ARIHIP (Wielen et al. 2001) - 91 thousand stars - selection of the best stars from FK6, GC+HIP, TYC2+HIP, HIP;
 - **Wielen introduced a classification 'astrometric excellence' (number of *).**
- ◆ EOC-2 (Vondrák & Ron 2004) - 4418 stars - combination of ARIHIP, TYCHO-2, Hipparcos & PPM with observations in programs of monitoring Earth orientation in 20th century.
- ◆ EOC-3 (Vondrák & Štefka 2007) - same as EOC-2, with periodic motions of 585 stars.



Some important catalogs of 20th century:

Name	year	No. stars	Epoch	σ ["]	σ_{μ} ["/cy]
GC (Boss)	1937	30 ths.	1900	0.15	1.0
SAO	1965	260 ths.	1930	0.15	1.5
FK5	1988	1535	1950	0.023	0.080
FK5 ext.	1991	3117	1950	0.059	0.267
PPM North	1991	182 ths.	1931	0.10	0.42
PPM South	1993	197 ths.	1962	0.07	0.30
AC 2000	1997	4.6 mil.	1907	0.2	0.4
Tycho	1997	1 mil.	1991.25	0.025	2.8
ACT	1997	1 mil.	1990.2	0.025	0.30
Hipparcos	1997	118 ths.	1991.25	0.0007	0.080



Accuracy of astrometric catalogs before Hipparcos

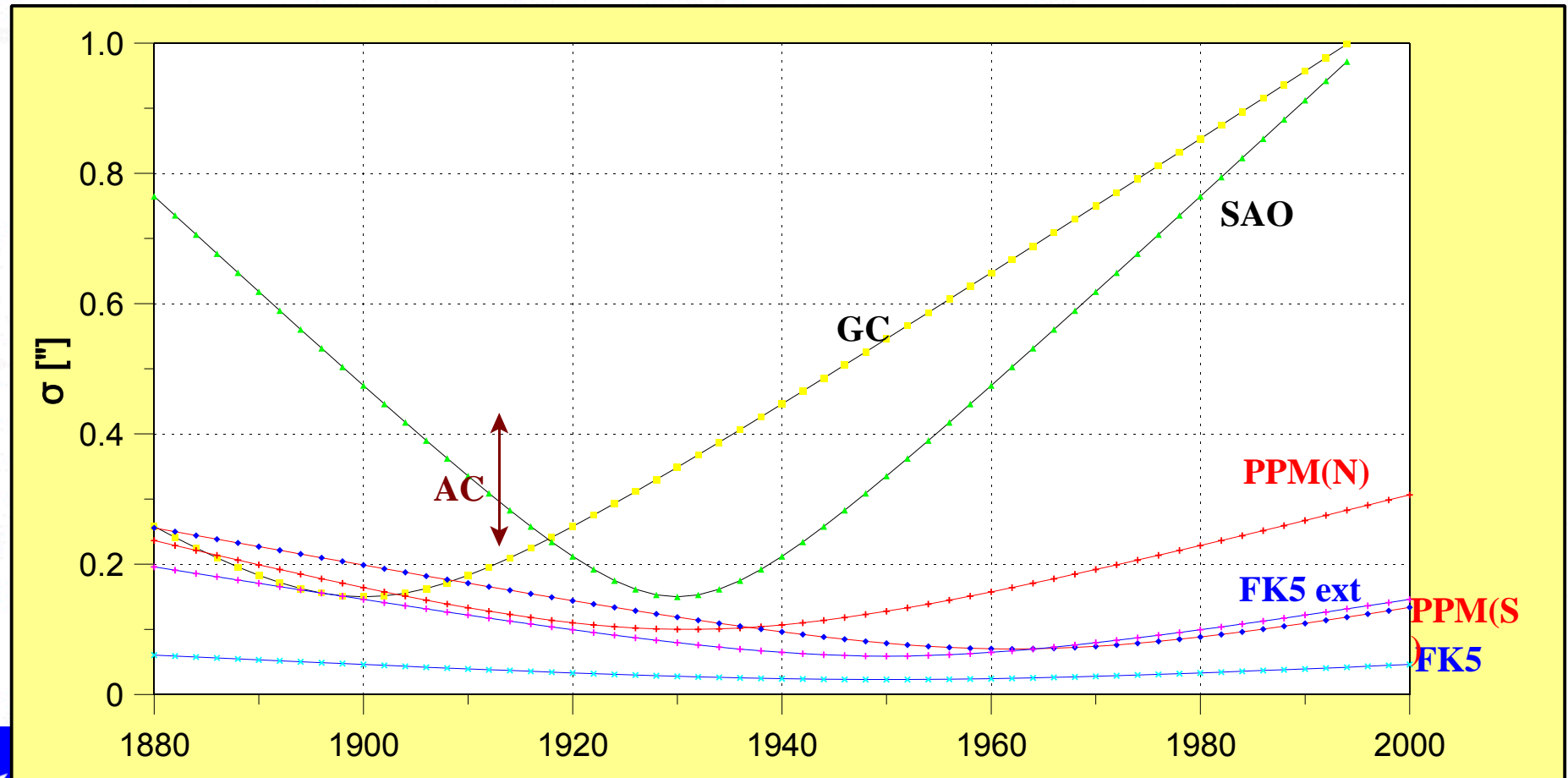

Summer School in Astronomy and Geophysics, Belgrade, August 2007



Accuracy of astrometric catalogs after Hipparcos

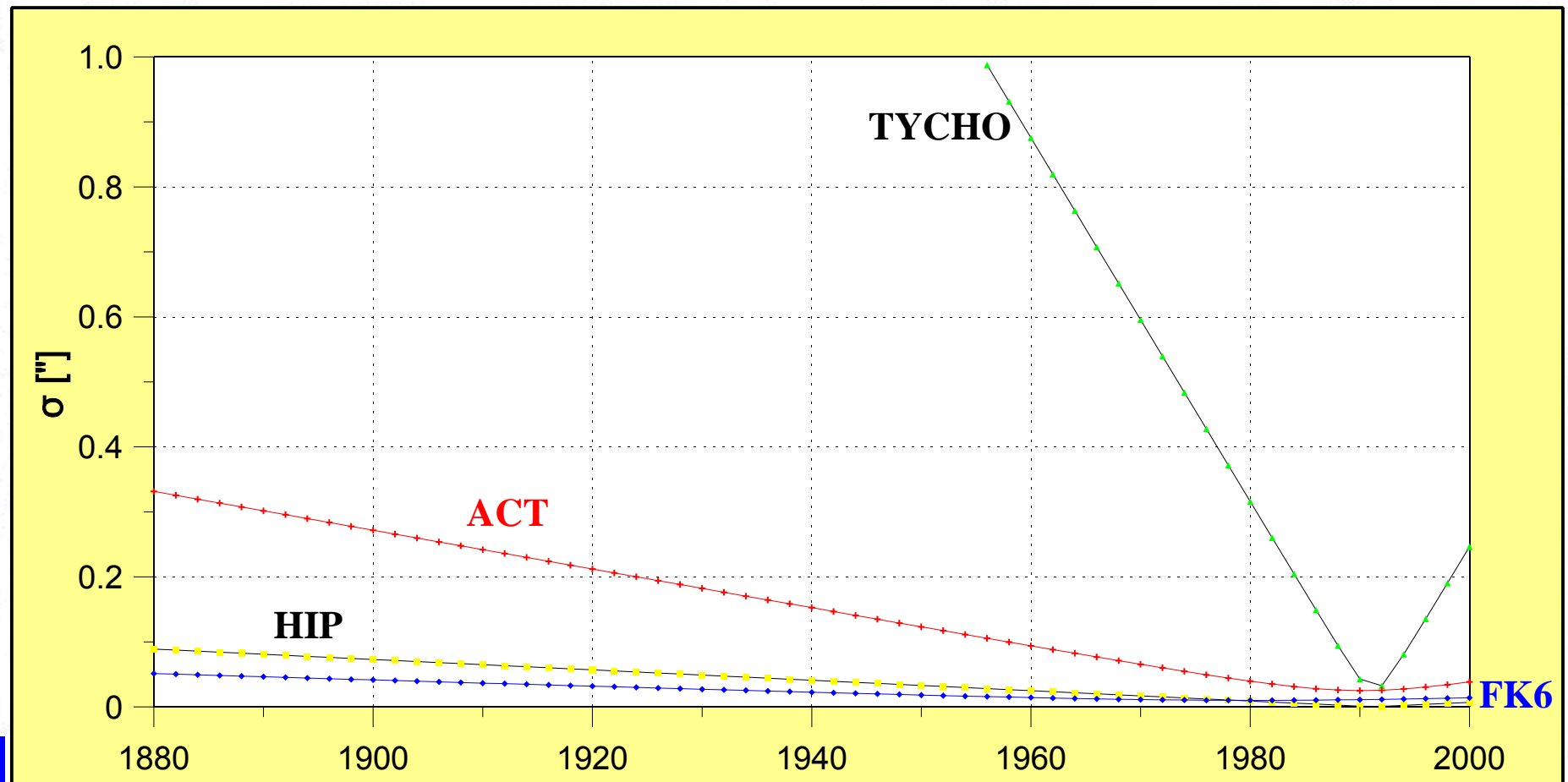

Summer School in Astronomy and Geophysics, Belgrade, August 2007



Earth Orientation Catalogue (EOC):

- **Data from 47 instruments at 33 observatories (1899-2003):**

- ◆ **10 PZT (φ , UT0):**

- 3 in Washington; 2 in Richmond and Mizusawa; 1 at Mount Stromlo, Punta Indio & Ondřejov;

- ◆ **7 photoelectric transit instruments (only UT0):**

- 3 in Pulkovo; 1 in Irkutsk, Kharkov, Nikolaev & Wuhang;

- ◆ **16 visual zenith-telescopes & similar instruments (only φ):**

- 7 ZT at ILS stations; 2 ZT in Poltava, 1 ZT in Beograd, Blagovestschensk, Irkutsk, Jósefoslaw & Pulkovo; FZT in Mizusawa; VZT in Tuorla-Turku;

- ◆ **14 equal altitude instruments - AST, PAST, CZ (δh):**

- 1 AST in Paris, Santiago de Chile, Shanghai, Simeiz & Wuhang; 2 PAST in Shaanxi, 1 PAST in Beijing, Grasse, Shanghai & Yunnan; 1 CZ in Bratislava, Prague & Ondřejov.



The solution

- All 4418 observed objects were identified in the most recent catalogs; their positions, proper motions, parallaxes and radial velocities were taken over from:
 - ◆ ARIHIP (2995);
 - ◆ TYCHO-2 (1248);
 - ◆ Hipparcos (144);
 - ◆ PPM (28);
 - ◆ Local catalogs (3);
- ⇒ zero version (EOC-0).
- Only 44 % stars of EOC-0 were classified as 'astrometrically excellent' ⇒ **further improvement is necessary!**



Origin of EOC stars and their astr. exc.

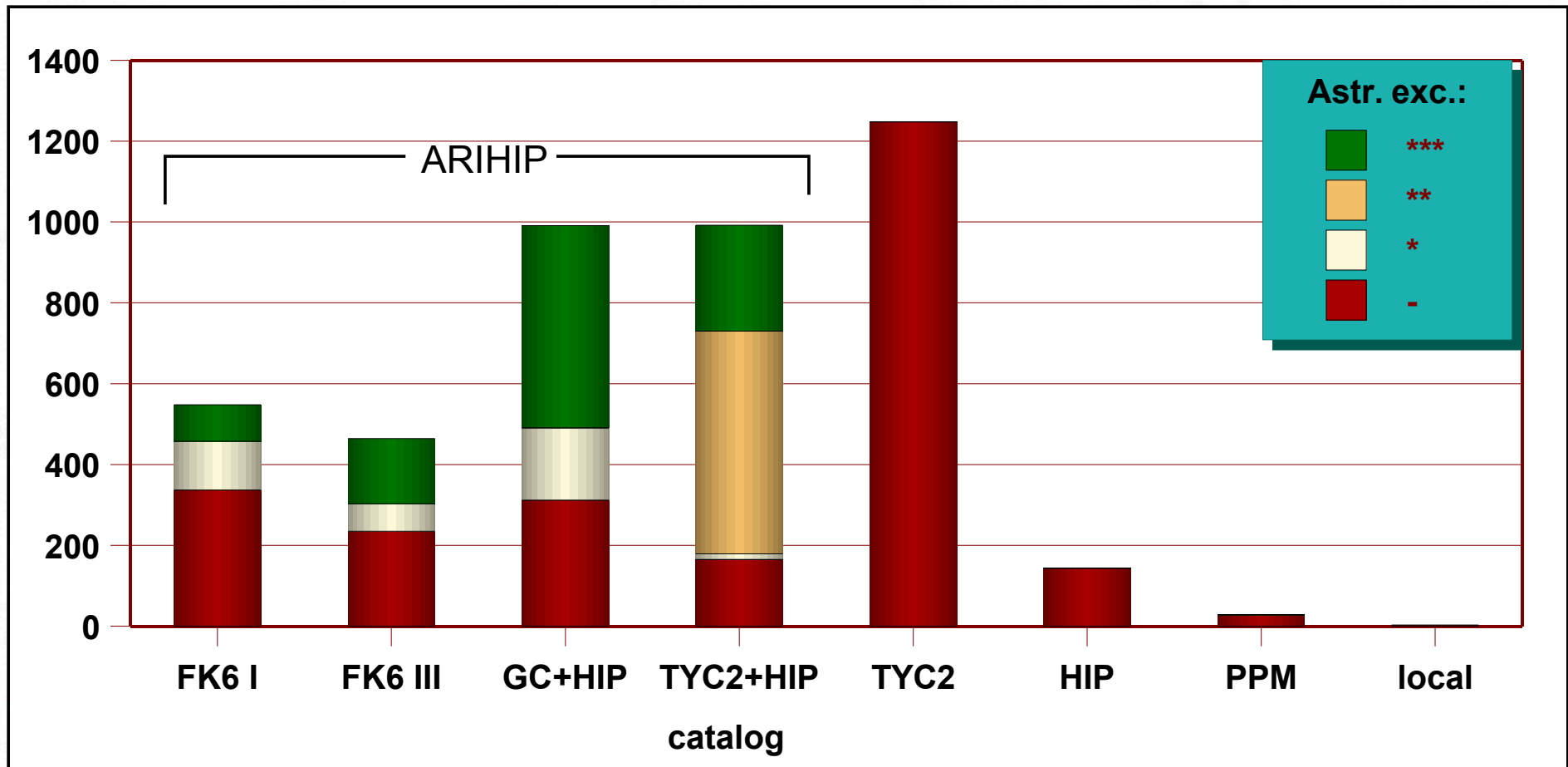

Magnitude distribution in EOC

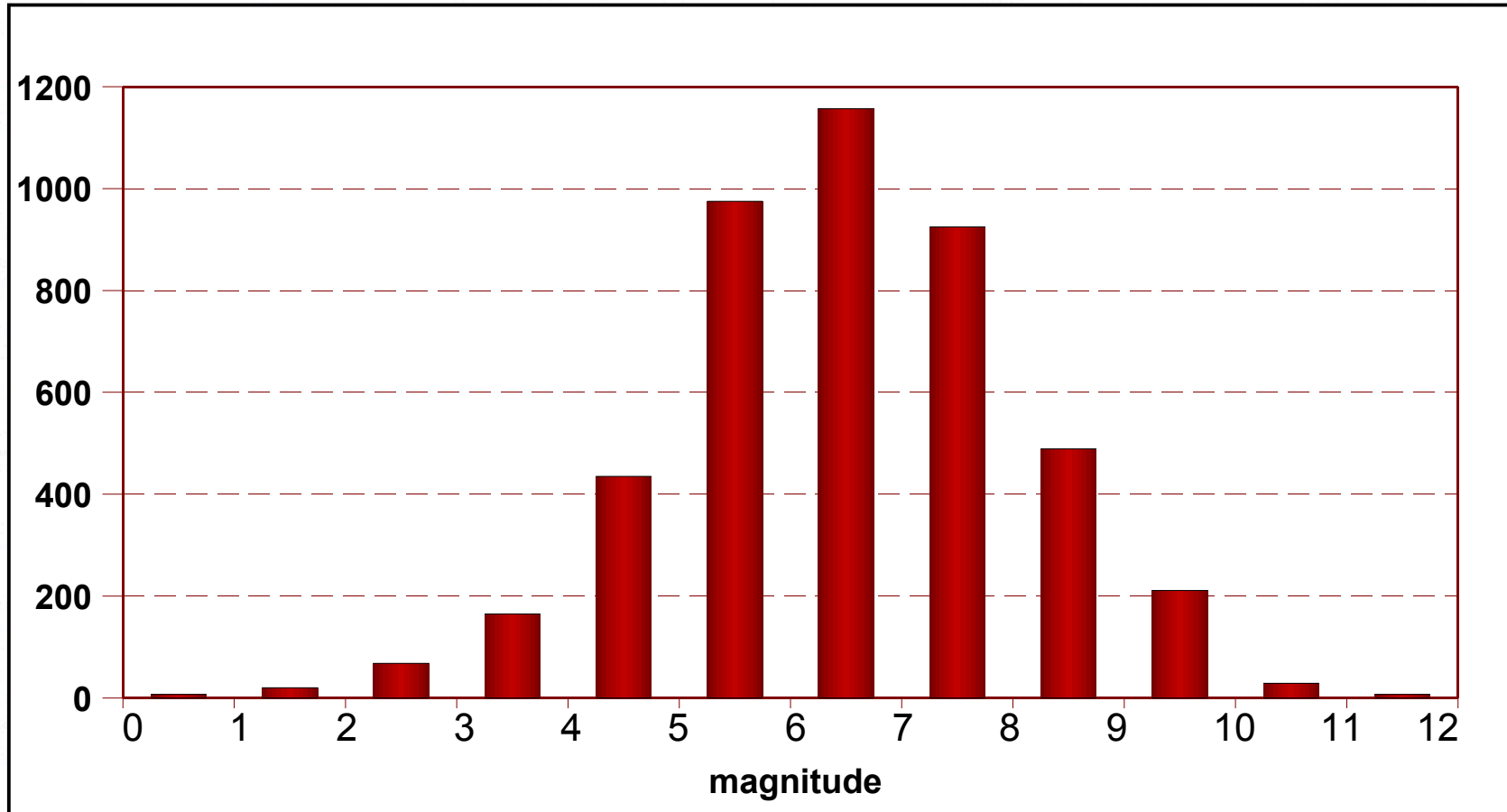

EOC-3 made in two independent steps:

- **Step 1 - improvement of positions & proper motions;**
- **Step 2 - looking for periodic changes.**



Step 1: Improvement of the positions & proper motions

- In average, each star observed 1000x, with precision of one observation about 0.2", usually in long interval (decades) \Rightarrow
 - ◆ Proper motions can be determined with precision competing with new catalogues (ARHIP etc...);
 - ◆ Combination of these observations with EOC-0 will bring an improvement;
- We follow a procedure similar to that of EOC-2.



Improvement... (cont.):

■ Strategy:

◆ To determine relative positions of all stars with respect to astrometrically excellent stars:

- Instantaneous latitude / universal time values transformed from original observations, using
 - ★ positions / proper motions from EOC-0, and
 - ★ new model of precession-nutation IAU2000A;
- Differences of latitude, universal time or altitude from the mean values of the night (astrometrically excellent stars only) are computed;
- Linear regression for the differences of the same star in different epochs is made;



- ◆ Stars with statistically significant deviations from EOC-0 are checked for multiplicity;
- ◆ In positive case, the displacement of reference point (often photocenter) from catalogue position is estimated,
- ◆ EOC-0 position is corrected.

Each star of catalogue EOC-0 is represented by three virtual observations of α , δ , in three epochs covering one century:

$t_1 = t_0 - 90$, $t_2 = t_0$, $t_3 = t_0 + 10$, with sigmas:

$$\begin{aligned}\sigma_1^2 &= 9000\sigma_\mu^2, \\ \sigma_2^2 &= \sigma_0^2 / [1 - (\sigma_0 / \sigma_\mu)^2 / 900], \\ \sigma_3^2 &= 1000\sigma_\mu^2.\end{aligned}$$

\Rightarrow weights



The weights:

- Standard errors in proper motion σ_μ for the stars from Hipparcos are multiplied by 2:
 - ◆ Weights for distant epochs diminished by a factor of 4;
- The weights calculated as $4 \times 10^4 / \sigma_i^2$,
 - ◆ reproducing the catalogue entry if virtual observations are subject to linear regression;
- Real observations are assigned weight = 1.



Observation equations for UT1, φ , h :

$$v_{UT} = \Delta\alpha^* + \Delta\mu_\alpha^*(t - t_o) - 15.041\Delta UT \cos\varphi$$

$$v_\varphi = \Delta\delta + \Delta\mu_\delta(t - t_o) - \Delta\varphi$$

$$v_h = \Delta\alpha^* \sin q + \Delta\mu_\alpha^*(t - t_o) \sin q + \Delta\delta \cos q + \Delta\mu_\delta(t - t_o) \cos q - \Delta h,$$

where q is the parallactic angle

observations

unknowns

Used always (for 3 virtual obs.)



Example - double star 84606 (Tycho-2), photocenter observed Combination of right ascension:

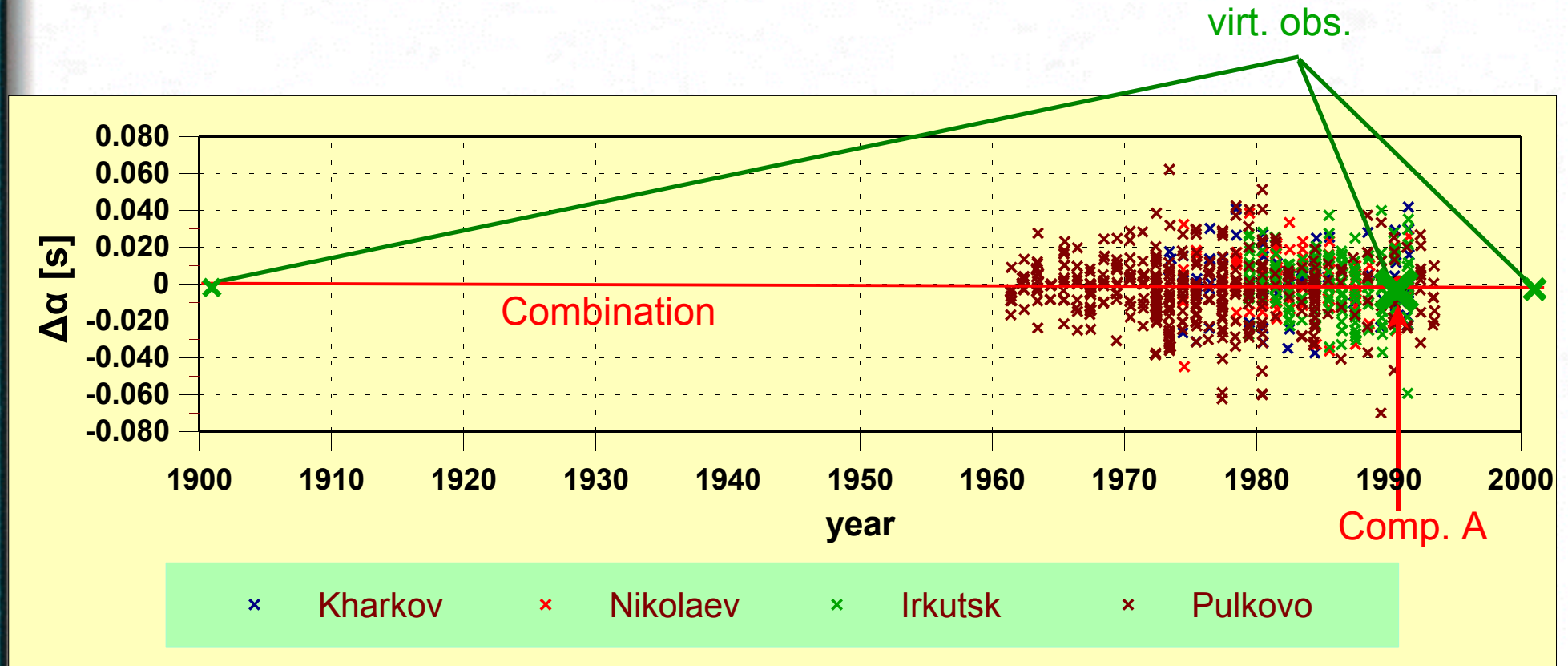

Combination of declination:

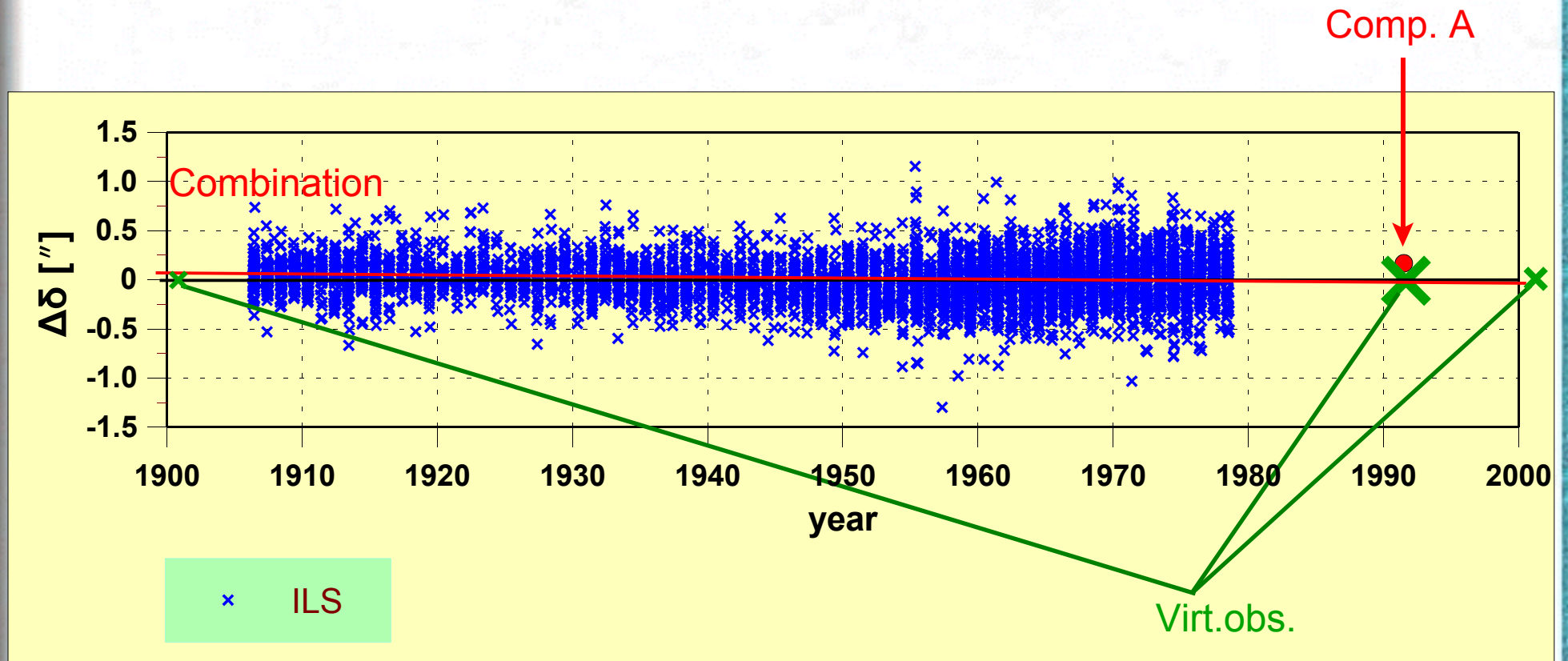

Step 2: Finding the periodic parts

- Spectral analysis of the residuals (annual mean values) by Lomb's method;
- Stars with dominant peaks looked up in **Hipparcos** and/or **6th Catalogue of Orbits of Visual Binary Stars**;
- Periods taken over primarily from these catalogues;
- sine/cosine terms estimated for up to two periods and their higher harmonics (≤ 8 coefficients) and tested for statistical significance;
- **585 stars** with significant periodic motions detected.



Example: star HIP111841 ($P = 43.6\text{y}$ from analysis)

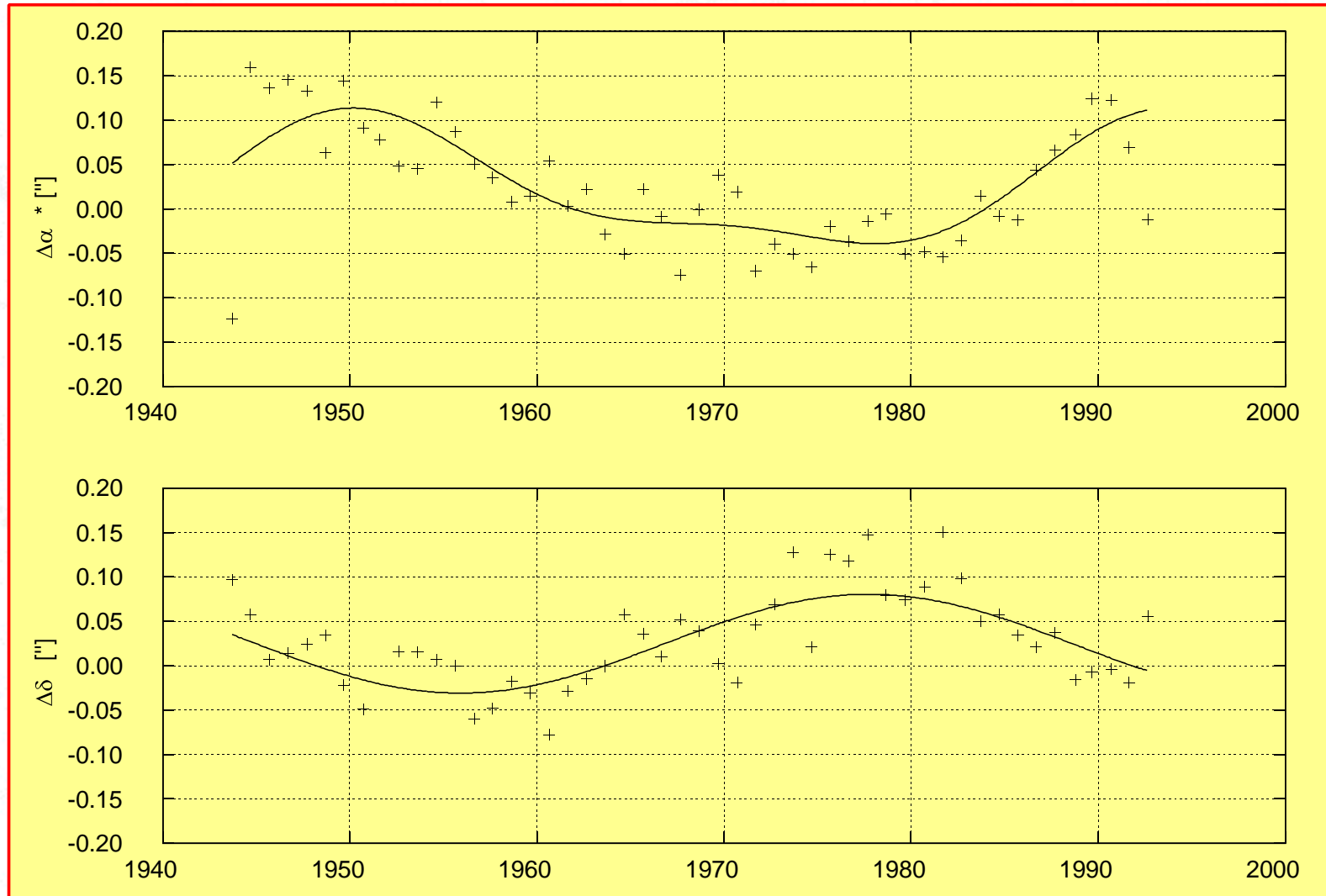

Summer School in Astronomy and Geophysics, Belgrade, August 2007



Example: star HIP114831 ($P = 11.4\text{y}$, 37.2y from analysis)

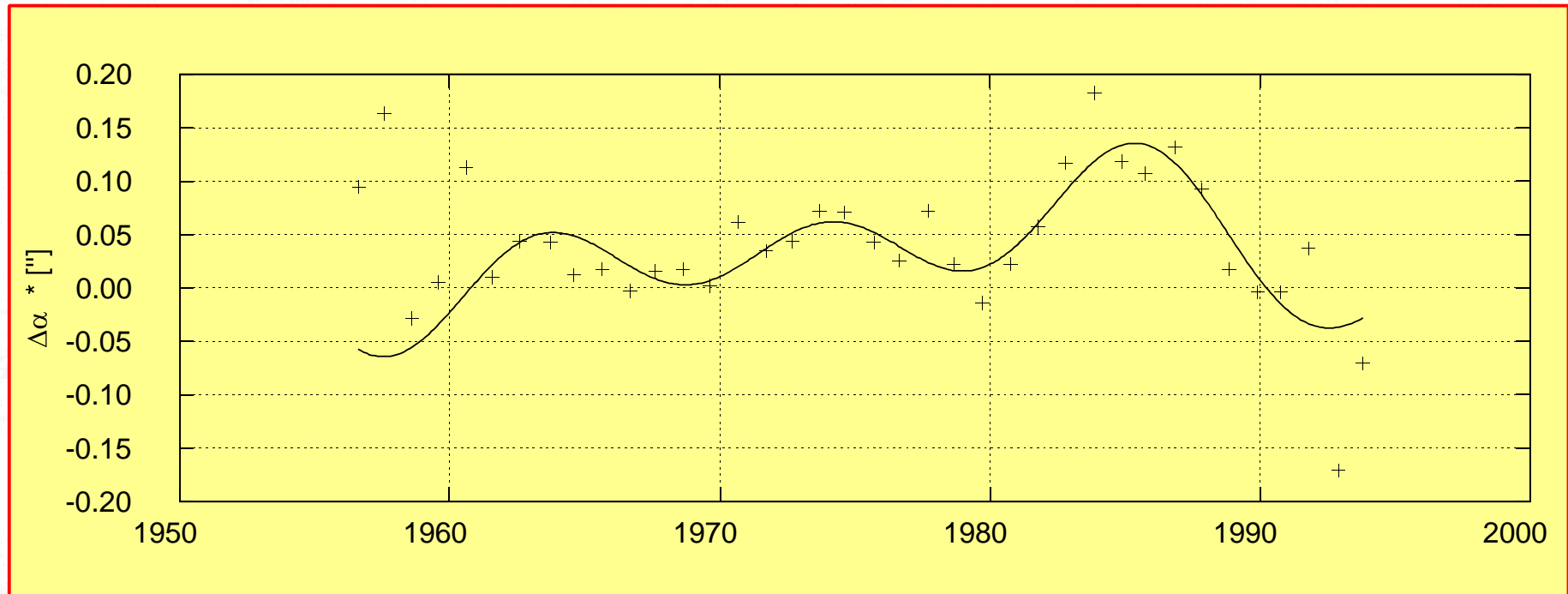

Example: star HIP86974 ($P = 65\text{y}$ from 6th Cat.)

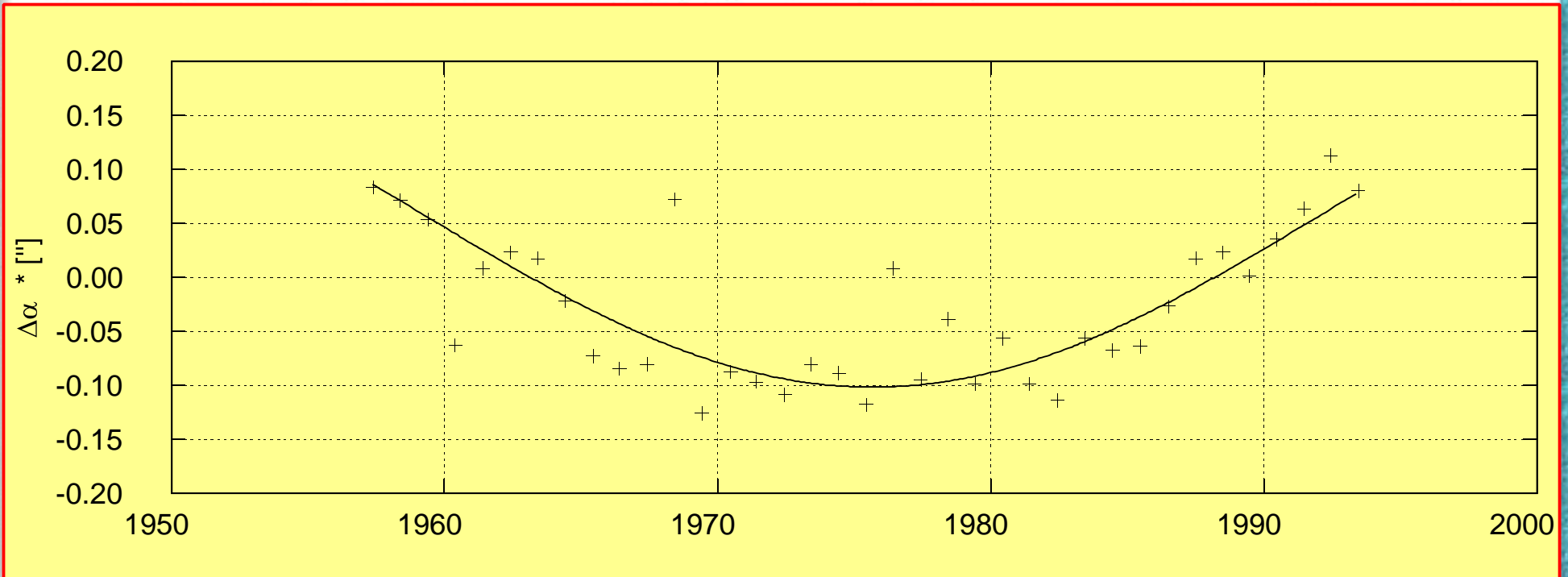

Standard errors of EOC-3:

ARIHIP population

TYCHO-2 population

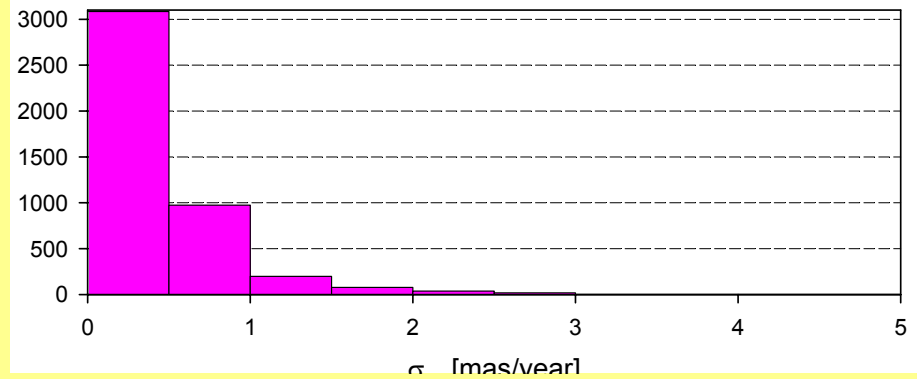
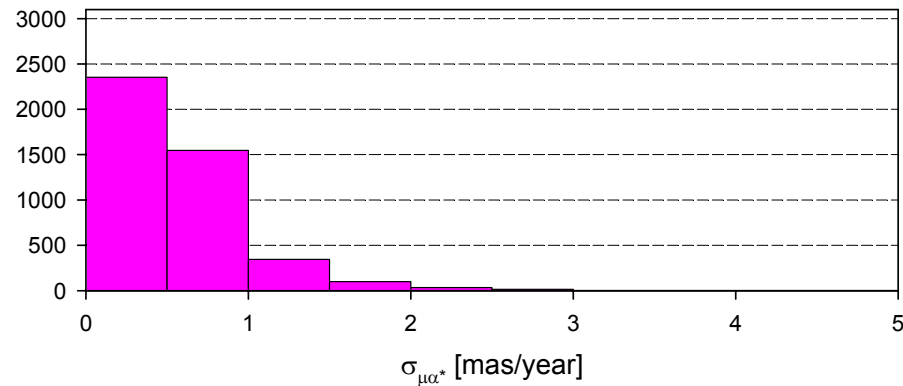
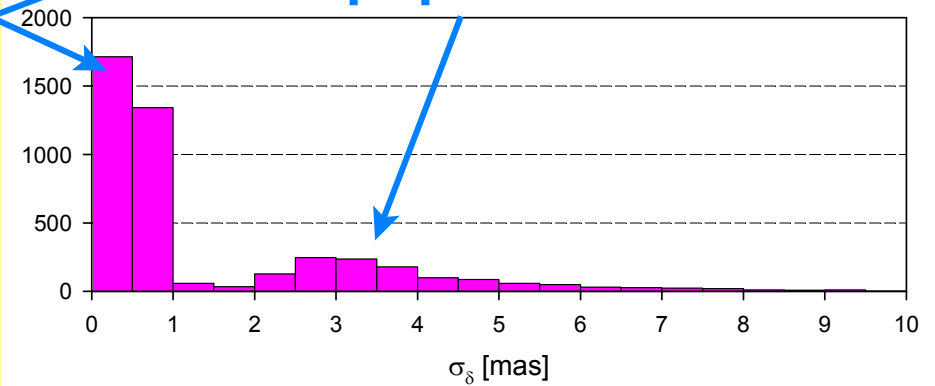
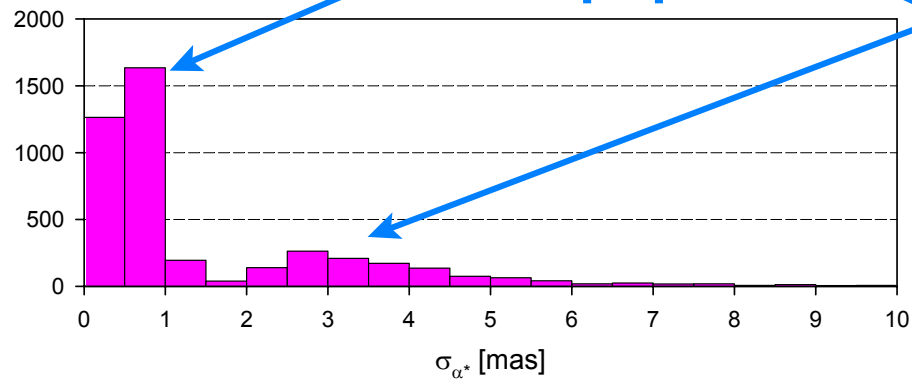

Conclusions

- Hipparcos satellite improved the precision of positions significantly;
- Proper motions are sometimes doubtful;
- Combination with long series of ground-based observations brings about a significant improvement of proper motions.

